



time お仕立上り価格表

2021-2025



Curtain 2021-2025

お仕立上り価格表

MODERN モダン

54001～54030

NATURAL ナチュラル

54031～54050

miffy ミッフィー

54051～54057

AUTHENTIC オーセンティック

54058～54103

PLAIN プレーン

54104～54155

kiōi 紀尾井

54156～54169

WA 和

54170～54182

SHAKOU 遮光

54183～54317

LACE レース

54318～54416

LINER ライナー

54417～54428

SHOWER CURTAIN シャワーカーテン

54429～54441

VP ONE PRICE
3300/m²

VPワンプライス価格表

VP101～VP158

NP ONE PRICE
2200/m²

NPワンプライス価格表

NP901～NP942

スタイル&ガイドブック価格表

形態安定加工（ドレープ標準仕様）

形態安定加工は、生地織り密度や糸の太さなどからくる硬さや反発でカーテンが横方向に広がってしまうことを抑える加工です。薬剤などを一切使わないで加工するので、環境にも安全で安心してご使用いただけます。

※生地それぞれの風合い、質感の違いにより仕上がり感は均一ではありません。



対応生地

左のマーク表示のある生地よりお選びください。

製作可能寸法

幅(W)：片開き 2,700 (mm) / 両開き 5,400 (mm) まで
丈(H)：2,800 (mm) まで

取扱上のご注意

洗濯3回程度までは形態安定加工の効果が保たれます(生地によって効果の持続性は異なります)。

- ◎シワが目立つ場合は、軽く蒸気を当てるか、霧吹きをしてヒダを整えて乾かしてください。
加工の特性上熱に弱いので、長時間熱が伝わるとプリーツが消失してしまう恐れがありますので十分ご注意ください。
- ◎ドライクリーニングは出来るだけ短時間で、タンブラー乾燥はお避けください。
- ◎アイロンは当てないでください。
- ◎加工品でもたたみジワがつきますので、保管の際はヒダごとにきれいにたたみ荷重がかからないように保管してください。

きれい

カーテン自体のドレープ性を向上させ美しいウェーブに仕上がります。

すっきり

カーテンのヒダを維持しながら加工を行いますので、収納時の納まりも綺麗で、洗濯後のお手入れも簡単です。

縫製タイプ	形態安定加工	芯地	ポリエステル芯地
縫い方	本縫い	両サイド	約20~25mmのダブル
フック	アジャスターフック	折り返し	
巾使い	2倍または1.5倍(指示のない場合は2倍)	裾折り返し	100mmのダブル (※120mmのダブル・150mmのダブル)
プリーツ	三つ山または二つ山(1.5倍の場合は二つ山)	たたみ方	プリーツたたみ
プリーツ間隔	約12cmまたは約15cm(1.5倍の場合は約15cm)	その他	両端にカーテンウエイト
上部折り返し	90mmまたは75mm(指示のない場合は90mm)		

※裾折返しを120mm以上のダブルでご指定の場合は、オプションとなります。

※レギュラー縫製とは納期が異なります。

※生地組成によりプリーツがV字になる場合があります。

※形態安定加工後は取扱い表示が変わります。P.270をご参照ください。

※形態安定加工はドレープ性を向上させるため、ヒダを深くした状態で加工を施しております。

1.5倍ヒダでの加工の場合、生地によりカーテンを閉じた時に隙間ができることがありますので仕上り巾は余裕を持ってご注文ください。

※生地巾やヒダ倍率により、巾継ぎ位置がヒダ山になる場合があります。

未加工品



レギュラー縫製仕様

未加工品では、生地風合い特性そのままの、自然なプリーツになります。

形態安定加工



形態安定加工

形態安定加工では、カーテンのヒダを整えながら生地張りを抑え、カーテン自体のドレープ性を向上させます。

品質向上のため、仕様を変更することがあります。

形状記憶加工

形状記憶加工は、繊維の奥まで形状をセットする本格的な加工で、美しいS字状のプリーツを長期間お楽しみいただける加工です。薬剤などを一切使わないで加工するので、環境にも安全で安心してご使用いただけます。

※生地それぞれの風合い、質感の違いにより仕上がり感は均一ではありません。



対応生地

左のマーク表示のある生地よりお選びください。

製作可能寸法

幅(W): 片開き 3,000(mm) / 両開き 6,000(mm) まで
丈(H): 2,700(mm) まで

取扱上のご注意

洗濯5回までは形態安定効果が十分保たれます。
プリーツ加工を施していますので水には耐久性が強く半永久的ですが、熱には弱く熱湯洗濯・タンブラー乾燥などにより、プリーツが消失する恐れがありますので、下記の点にご注意ください。

- ◎たたみジワなどでヒダがあまりなくなった場合は、軽く蒸気を当てるか、霧吹きをしてヒダを整えて乾かしてください。
- ◎ドライクリーニングは出来るだけ短時間で、タンブラー乾燥はお避けください。
- ◎アイロンは当てないでください。
- ◎加工品でもたたみジワがつきますので、保管の際はヒダごとにきれいにたたみ荷重がかからないように保管してください。

※起毛生地など特殊な織りかたをしている生地や、モールなどの意匠系を使用している生地などは、それらの持つ独特な風合いが損なわれる恐れがあるためおすすめできません。

きれい

カーテンの両みみまでプレスされているので、とても美しい仕上がりです。

くっきり

従来の加工と違い、最新のプレス機を使用していますので、はっきりとしたS字のプリーツが出ます。

長持ち

従来品のU字プリーツと違って、プリーツだたみをしてV字になりにくく、美しいS字のまま長期間吊ることができます。

縫製タイプ	形状記憶加工	芯地	ポリエステル芯地
縫い方	本縫い	両サイド 折り返し	約25mmのダブル、 リターン約30mm
フック	アジャスターフック (横ブレ防止タイプ)	裾折り返し	100mmのダブル (※120mmのダブル・150mmのダブル)
巾使い	約2倍	たたみ方	プリーツたたみ
プリーツ	三つ山	その他	ウエイトなし
プリーツ間隔	約12cm		
上部折り返し	90mm		

※裾折返しを120mm以上のダブルでご指定の場合は、オプションとなります。
※レギュラー縫製とは納期が異なります。
※形状記憶加工後は取扱い表示が変わります。P.270をご参照ください。
※生地巾やヒダ倍率により、巾継ぎ位置がヒダ山になる場合があります。

未加工品



レギュラー縫製仕様

未加工品では、生地の風合い特性そのままの、自然なプリーツになります。

形状記憶加工



形状記憶加工

形状記憶加工では、均一でなめらかなS字のプリーツが長期間楽しめます。

レギュラー縫製仕様

リリカラのスタンダードな標準縫製です。



3つ山ヒダ

プリーツ

- 3つ山ヒダ
- 2つ山ヒダ
- 箱ヒダ

※1.5倍ヒダの場合は
2つ山ヒダ

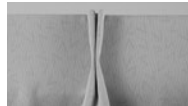

2つ山ヒダ



耳

- 約20~25mmの
ダブル仕上げ
- 本縫い

縫い方

- ドレープ…本縫い
- レース…本縫い
- 巾継ぎ
ドレープ…インターロック仕上げ
レース…二重環縫い仕上げ



フック

- 90mmまたは75mm、
アジャスターフック

芯地

- ドレープ…ポリエステル芯地
- レース…ポリエステル芯地
- インターロック仕上げ
- 本縫い

裾(すそ)

- 100mmまたは
120mmのダブル仕上げ
- 本縫い
- コーナー … 両端にウエイト入り

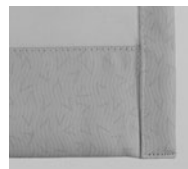

梱包

- リリカラネーム入り専用箱
- プリーツたたみ

※生地によりかぶせ縫い
※生地巾やヒダ倍率により、
巾継ぎ位置が
ヒダ山になる場合があります。

※1巾で製作可能な上がり巾は以下の通りとなります。
生地巾100cmで約2倍ヒダ・片開きの場合、W440まで
生地巾150cmで約2倍ヒダ・片開きの場合、W670まで

フラットカーテン縫製仕様

上部はヒダなしで、フラットな仕上がりです。窓辺をスッキリと演出します。



レギュラープレーン縫製仕様



カスタムプレーン縫製仕様



フックの厚みが生地表
に出ず、フックを固定
した縫製仕様です。

ウエイトテープ巻きロック加工



ボイル生地(ヨコ使い生地)にはウエイトテープ巻きロック加工を
おすすめします。
裾の折り返しが不要となり、すっきりとした裾まわりをつくります。

プライム縫製仕様

リリカラのワンランク上の縫製仕様です。
巾継はプリーツのピッチの間で行い、標準は約2倍ヒダで
形態安定加工による仕上げとなります。

製作可能寸法

幅(W): 片開き 2,700(mm) / 両開き 5,400(mm) まで
丈(H): 2,800(mm) まで

プリーツ

- 標準は約2倍ヒダ3つ山
- ※1.5倍ヒダは2つ山

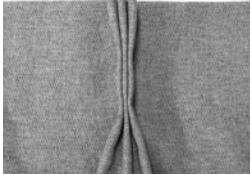

芯地

- ポリエステル芯地
- 本縫い

フック

- 90mmまたは75mm

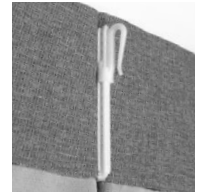

アジャスターフック
差し込み式の
横ブレ防止タイプ。
きれいなヒダ山を
つくります。

耳

- 約25mmのダブル仕上げ
- 本縫い

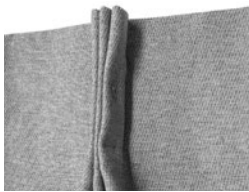
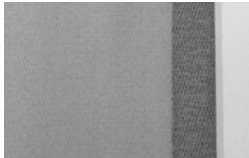

巾継

- 巾継の位置
- ※2倍ヒダドレープ・レースの組み合わせで生地巾が異なる場合は、ヒダ山の数を揃えると巾継はピッチの間にならない場合があります。
- ※1.5倍ヒダの巾継はピッチの間にならない場合があります。

裾(すそ)

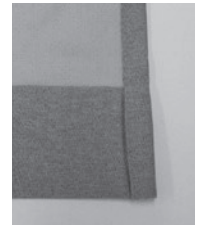

- 100mmまたは120mmのダブル仕上げ
- 本縫い
- コーナー… 両端にウエイト入り

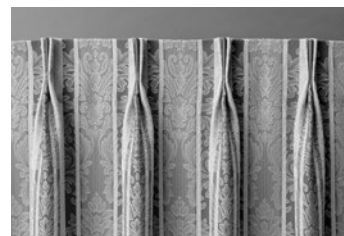
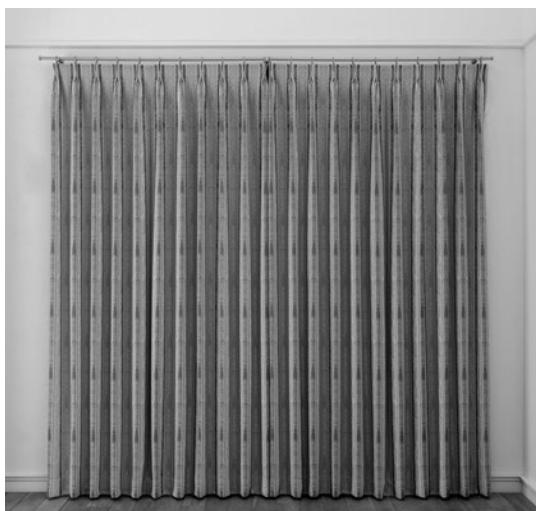

プライム縫製仕様 (パターン仕立て)

ヨコリビート25cm程度の生地で通常の縫製に
1巾プラスしていただくとパターン仕立てができます。

ギャザーテープ仕様

約2.5倍の巾使いとなります。ユニバーサルギャザーテープと、フレアーギャザーテープがあります。

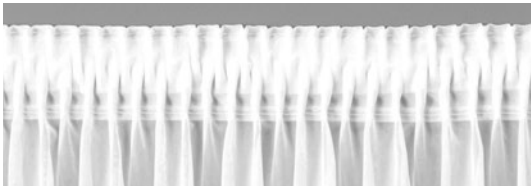

フレアーギャザーテープ



ユニバーサルギャザーテープ

フラットライナー

低価格で裏地を取り付けることができます。

現在ご使用中のカーテンに裏地を取り付けることができます。「サイドクリップ」の採用により簡易性を高めました。

ヒダのないフラットな裏地です。(生地は54417～54428よりお選びください。)

フラットライナーなし

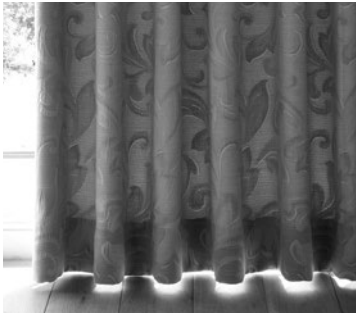

フラットライナー取り付け後



表地のカーテンを日差しから守ります。



外観も美しく仕上がります。

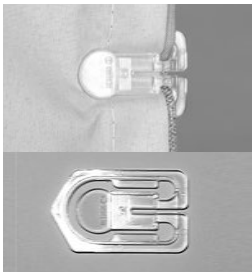

サイドクリップ

左写真のように、カーテンの両サイドを「サイドクリップ」で固定します。

丈の寸法に合わせて、片側3～4個取り付けます。

サイドクリップ 93402：8ヶ入り/1パック700円

※フラットライナー1窓につき、片開き1パック(両開き2パック)別途必要です。

※フラットライナー縫製仕様価格表はサイドクリップ2パックを含みます。

無色透明※の専用クリップです。

マジックテープを縫付ける必要がありませんので、
どんなカーテンにも簡単に取り付けすることができます。

※2019年7月以降、在庫が無くなり次第、乳白色の専用クリップに変更いたします。



フラットライナーは、カーテン本体のフックを利用して取り付けます。
新たなフックは必要ありません。

フラットライナーの取り付け方

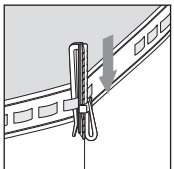

お手持ちのカーテンからフックを外し、フラットライナー裏側のフラットライナーテープに等間隔に割り付けます。次にフックを下に向け、ライニングテープに上から差し込みます。

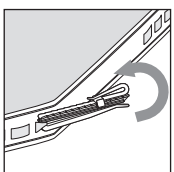

フックをくるりと反転します。

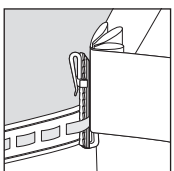

カーテンのヒダにフックを差し込みます。カーテンをレールに取り付けた後に左右の位置を整え、専用のサイドクリップで固定します。

フラットライナーのみご注文の場合

①お手持ちのカーテンの巾と丈を測ってください。

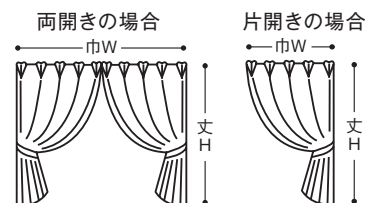

※両開きの場合は2枚分の合計です。

- 巾はフックの右端から左端までの長さ
- 丈はフック上からカーテンの裾までの長さ(カン下仕上寸法)

②お手持ちのカーテン仕様をご確認ください。

- 両開き/片開き
- 天付け/正面付け
- フックの寸法(75mm/90mm等)

カーテンと同時にご注文の場合

①～② 必要ありません。下記の方法で表生地と同時にご注文ください。

ご注文方法

- 商品名 フラットライナー
- 生地品番 54000
- 表生地の寸法
仕上り巾
●両開きの場合は2枚分の合計の巾
●片開きは1枚分の巾
仕上り丈 カン下仕上り寸法
- 表生地の仕様
●両開き/片開き
●天付/正面付
●フック(75mm/90mm等)
- 窓数 窓の数をご指定ください。

シャワーカーテン縫製仕様

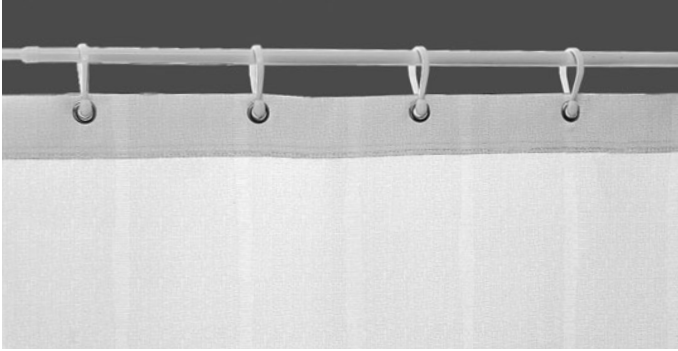

ニッケル ゴールド 黒ニッケル

ハトメサイズ	内径9mm
ハトメ素材	真鍮
ハトメの重さ (1つあたり)	約1g
カン上寸法	約10mm
ハトメ間隔	約15cm

- サイズは、総巾X総丈でご注文ください。
- ハトメカラーは下記よりいずれかをご指定ください。
※ご指定がない場合はニッケルで作成します。
 - ニッケル • ゴールド • 黒ニッケル
 カーテンポールとカーテンをとめる部品としてSカン又はリングバックを用意しています。縫製加工依頼時にご注文ください。

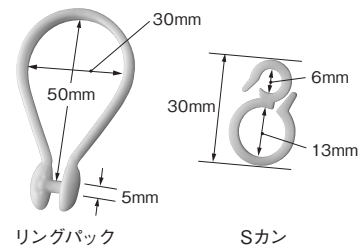

リングバック

Sカン

- 両サイド耳仕様
 - 直線超音波カット加工
 ※耳を折り返し仕様にする場合はご指定ください。
- 裾部仕様 (超音波カット加工) は、下記よりいずれかをご指定ください。
 - 直線
 - ウェーブ大 (ウェーブ巾約80mm)
 - ウェーブ小 (ウェーブ巾約39mm)
 ※ご指定がない場合は直線にて仕上げます。
- 対応品番
 - TM-54429~54436
 - TM-54437・54438
 - TM-54439~54441

※特殊掛率品

品番：リングバック 93419 カラー：ホワイト
袋詰数量：1セット(10ヶ入) 価格：600円

品番：Sカン 93424 カラー：ホワイト
袋詰数量：1セット(10ヶ入) 価格：400円

TM-54429 ~54436の縫製について

巾方向を丈として使用しますので、巾つなぎの必要がなく美しく仕上がります。仕上り丈が180cmを超える場合、生地をタテ使いすることで縫製可能になります。この場合、ヨコ使いとは柄の出方が多少異なります。縫製加工依頼時に「生地タテ使い」とご指示ください。

取扱上のご注意

縫製の際はハトメ加工をおすすめします。使用後はカビの発生を防ぐため汚れを洗い流してください。月1回程度は、取扱い表示にしたがって洗濯をおこない、十分に乾燥させてください。

■ 上部仕様 (ハトメ仕様)

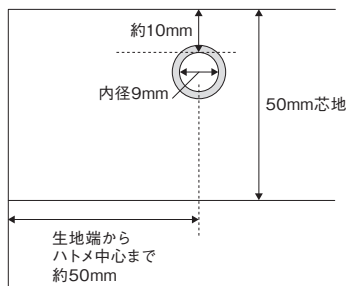

■ 裾部仕様 (超音波カット加工)

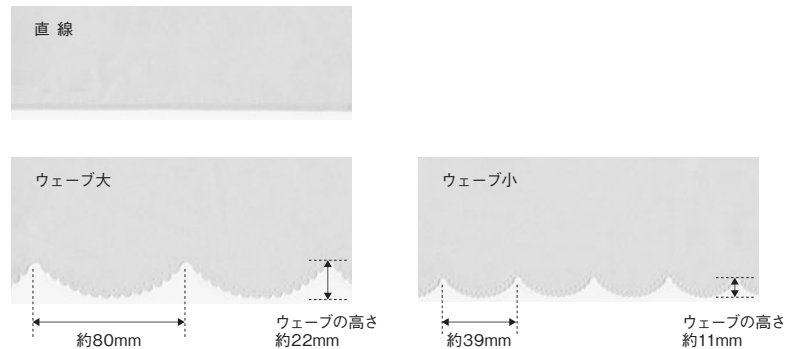

※カビの発生を抑制するため、折り返しをせず左右・裾に超音波カット加工を施しています。

リターン仕様

カーテンの両サイドを長めに作り、レールを囲う仕様になります。



レールの左右の隙間をふさぐことで光漏れ(特に遮光生地)が軽減され、外部からの視線をカットし、冷暖房効果が期待できます。

■ リターン仕様のご注文方法

- 両開きの場合：リターンサイズ※1 及びリターンを付ける側(両サイド)をご指定ください。
両開きの片側だけにリターンを付ける場合は付ける側(右・左)をご指定ください。

下図のように簡単なイラストを添付してご指定ください。

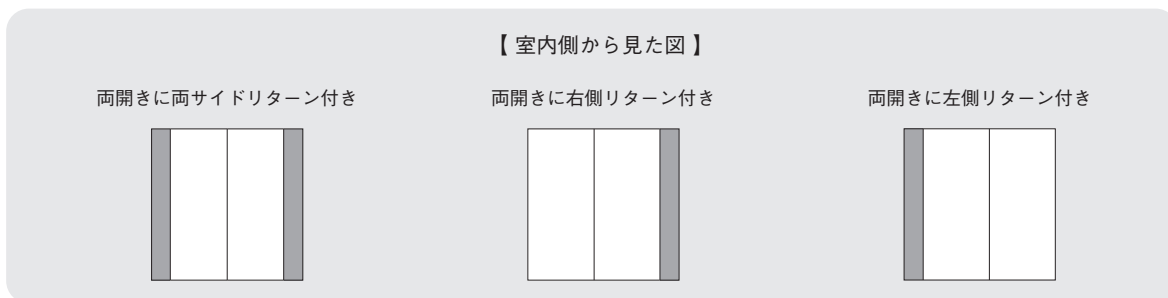

- 片開きの場合：リターンサイズ※1 及びリターンを付ける側(右・左)をご指定ください。

【注意】

- ※1 リターンサイズは下図「A+B」の合計サイズでご指定ください。
耳サイズ(B)のご指定がない場合は「25mm」の三つ巻仕様に仕上げます。(耳サイズ20・25・30mmのいずれかを指定可能) 形態安定加工品について、リターンサイズ(A+Bの合計)は最大12cmまでとなります。
- ※仕上りサイズ、ヒダ倍率によって1巾多く必要になる場合がありますので予めご了承ください。
- ※価格についてはリターンを含む総仕上り巾の価格表をご覧ください。

【イメージ図】

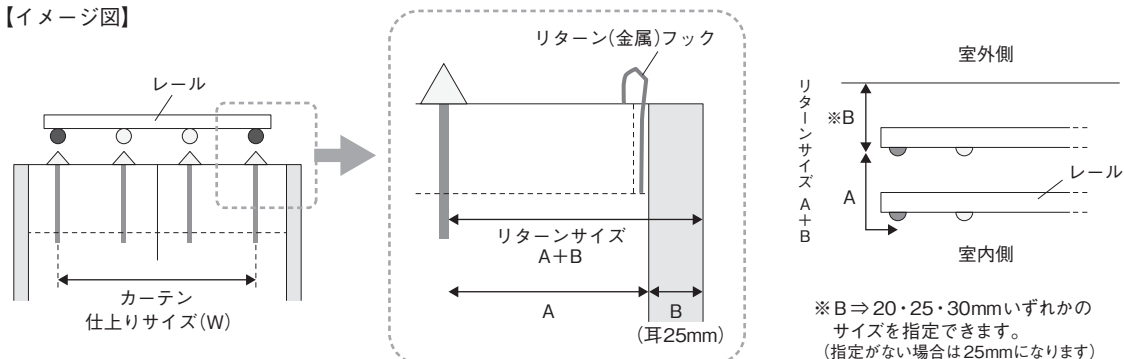

【例】カーテン仕上りサイズW1,800×H1,800(両開き)に100mmのリターンを両サイドに付け、耳サイズ30mm指定の場合。

カーテンのご注文サイズ、仕様及び、「リターン付き両サイド各100mm」「耳30mm」とご注文ください。
→この場合、上図の「Aのサイズ：70mm+Bのサイズ：30mm」を両サイドに作成いたします。

&time Curtain 2021-2025

スタイルマーク紹介

スタイルマーク	スタイル説明	スタイル No.
 センタークロス	中央でほんの少しカーテンを交差させた、優しい印象のスタイルです。 共生地フリル(No.11)と、レースフレンジ(No.12)が付いたスタイルがあります。	Style No. 11 センタークロス (共生地フリル) Style No. 12 センタークロス (レースフレンジ)
 セパレーツ	かわいいリボンやフリルがポイントの、出窓や小窓に合うスタイルです。	Style No. 15 セパレーツ
 スカラップ M型	出窓や腰窓に合い、裾に美しいウェーブを見せるスタイルです。 裾に共生地フリル (No.17)と、レースフレンジ (No.18) が付いたスタイルがあります。	Style No. 17 スカラップ M型 (共生地フリル) Style No. 18 スカラップ M型 (レースフレンジ)
 スカラップ W型	出窓や腰窓に合い、裾に美しいウェーブを見せる開口部の小さいスタイルです。 裾に共生地フリル (No.19)と、レースフレンジ (No.20) が付いたスタイルがあります。	Style No. 19 スカラップ W型 (共生地フリル) Style No. 20 スカラップ W型 (レースフレンジ)
 アーチ	出窓や腰窓に合い、裾にゆるやかなカーブを見せるスタイルです。 裾に共生地フリル (No.26)と、レースフレンジ (No.27) が付いたスタイルがあります。	Style No. 26 アーチ (共生地フリル) Style No. 27 アーチ (レースフレンジ)
 バルーン プレーン	シェードが上がるにつれてふんわりとしたウェーブが特長のスタイル。 シンプルなプレーンスタイルです。	Style No. 50 バルーンシェード (プレーン)
 バルーン フリル	シェードが上がるにつれてふんわりとしたウェーブが特長のスタイル。 裾に共生地フリルが付いたスタイルです。	Style No. 51 バルーンシェード (共生地フリル)
 プレーン シェード	生地を水平にたたみながら上下に昇降する、シンプルなスタイルです。	Style No. 60 プレーンシェード
 シャープ シェード	シャープなラインを美しく保ちながら、上下に昇降するスタイルです。	Style No. 63 シャープシェード
 ソフト ロールソフト	カーテン生地に特殊な裏地を熱で圧着して製作するロールスクリーンです。 生地の素材感をそのままお楽しみいただけます。 ※ロールソフト加工品は全て非防炎品になります。	Style No. S01 ロールソフト

スタイルカーテン仕様説明

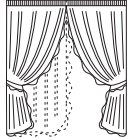
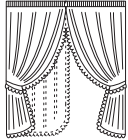
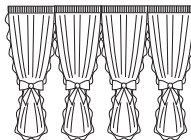
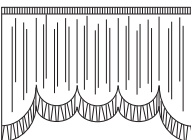
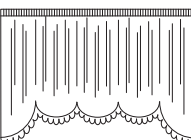
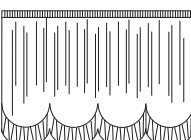
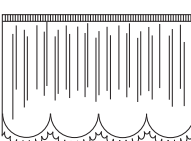
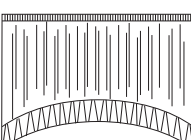
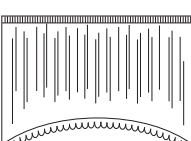
スタイル		仕様説明
	<p>Style No. 11 センタークロス (共生地フリル)</p>	<ul style="list-style-type: none"> ◇ 上部仕様：ギャザーヒダ ◇ ヒダ倍率：2.5倍 ◇ 摘要：フリル巾6～8cm ◇ 両開き・片開き：両開き仕様 ◇ タッセル：フリルタッセル付
	<p>Style No. 12 センタークロス (レースフレンジ)</p>	<ul style="list-style-type: none"> ◇ 上部仕様：ギャザーヒダ ◇ ヒダ倍率：2.5倍 ◇ 両開き・片開き：両開き仕様 ◇ タッセル：レースフレンジタッセル付
	<p>Style No. 15 セパレーツ</p>	<ul style="list-style-type: none"> ◇ 上部仕様：ギャザーヒダ ◇ ヒダ倍率：2.5倍 ◇ 摘要：フリル巾6～8cm ◇ 両開き・片開き：固定タイプ ◇ タッセル：リボンタッセル付
	<p>Style No. 17 スカラップ M 型 (共生地フリル)</p>	<ul style="list-style-type: none"> ◇ 上部仕様：ギャザーヒダ ◇ ヒダ倍率：2.5倍 ◇ 摘要：裾フリル巾16cm ◇ 開口部：丈の約20% (最大30cmまで) ◇ 両開き・片開き：固定タイプ ◇ タッセル： —
	<p>Style No. 18 スカラップ M 型 (レースフレンジ)</p>	<ul style="list-style-type: none"> ◇ 上部仕様：ギャザーヒダ ◇ ヒダ倍率：2.5倍 ◇ 摘要：裾レースフレンジ仕様 ◇ 開口部：丈の約20% (最大30cmまで) ◇ 両開き・片開き：固定タイプ ◇ タッセル： —
	<p>Style No. 19 スカラップ W 型 (共生地フリル)</p>	<ul style="list-style-type: none"> ◇ 上部仕様：ギャザーヒダ ◇ ヒダ倍率：2.5倍 ◇ 摘要：裾フリル巾16cm ◇ 開口部：20cm ◇ 両開き・片開き：固定タイプ ◇ タッセル： —
	<p>Style No. 20 スカラップ W 型 (レースフレンジ)</p>	<ul style="list-style-type: none"> ◇ 上部仕様：ギャザーヒダ ◇ ヒダ倍率：2.5倍 ◇ 摘要：裾レースフレンジ仕様 ◇ 開口部：20cm ◇ 両開き・片開き：固定タイプ ◇ タッセル： —
	<p>Style No. 26 アーチ (共生地フリル)</p>	<ul style="list-style-type: none"> ◇ 上部仕様：ギャザーヒダ ◇ ヒダ倍率：2.5倍 ◇ 摘要：裾フリル巾16cm ◇ 開口部：丈の約20% (最大30cmまで) ◇ 両開き・片開き：固定タイプ ◇ タッセル： —
	<p>Style No. 27 アーチ (レースフレンジ)</p>	<ul style="list-style-type: none"> ◇ 上部仕様：ギャザーヒダ ◇ ヒダ倍率：2.5倍 ◇ 摘要：裾レースフレンジ仕様 ◇ 開口部：丈の約20% (最大30cmまで) ◇ 両開き・片開き：固定タイプ ◇ タッセル： —

ローマンシェード仕様説明

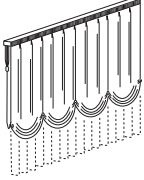
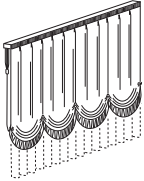
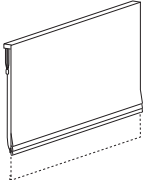
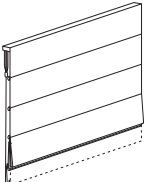
スタイル	仕様説明	仕様説明
	<p>Style No. 50 バルーンシェード (プレーン)</p>	<ul style="list-style-type: none"> ◇ 上部仕様：ギャザーヒダ ◇ ヒダ倍率：2.5倍 ◇ 摘 要：スワッグは均等割付 ◇ 仕上り巾 コード式：36～250cm ◇ 仕上り巾 ドラム式：40～400cm ◇ 仕上り丈：100～300cm ◇ 出窓対応 コード式：2・3連 / ドラム式：2～5連
	<p>Style No. 51 バルーンシェード (共生地フリル)</p>	<ul style="list-style-type: none"> ◇ 上部仕様：ギャザーヒダ ◇ ヒダ倍率：2.5倍 ◇ 摘 要：スワッグは均等割付 / 裾フリル巾16cm ◇ 仕上り巾 コード式：36～250cm ◇ 仕上り巾 ドラム式：40～400cm ◇ 仕上り丈：100～300cm ◇ 出窓対応 コード式：2・3連 / ドラム式：2～5連
	<p>Style No. 60 プレーンシェード</p>	<ul style="list-style-type: none"> ◇ 仕上り巾 コード式：30～240cm ◇ 仕上り巾 ドラム式：30～400cm ◇ 仕上り丈：50～300cm ◇ 仕上り丈：ドラム式：仕上り巾39cm以下の場合、 仕上り丈は200cmまでとなります。 ◇ 出窓対応：不可
	<p>Style No. 63 シャープシェード</p>	<ul style="list-style-type: none"> ◇ 摘 要：バーピッチは約15cmで均等 ◇ 仕上り巾 コード式：30～240cm ◇ 仕上り巾 ドラム式：30～400cm ◇ 仕上り丈：50～300cm ◇ 仕上り丈：ドラム式：仕上り巾39cm以下の場合、 仕上り丈は200cmまでとなります。 ◇ 出窓対応：不可

価格算出方法

推奨裏地付縫製価格算出方法

裏地付縫製の価格は、下記の方法にて算出ください。

- ① 表地の価格に裏地の価格をプラスしてください。その場合に表地と裏地の生地巾にご注意ください。

$$\text{表地の生地巾} \times \text{表地の巾数} \div \text{裏地の生地巾} \doteq \text{裏地の巾数} \quad (\text{小数点第1位切り上げ})$$

- ② 表地は、仕上り寸法の価格をご覧ください。
裏地は、上記で算出された巾数の価格をご覧ください。 ※他の裏地品番との組み合わせも同様の算出方法です。
- ③ 裏地と組成の合う裏地をお選びいただくとより美しく仕上がります。
- ④ 表地と裏地の寸法変化率の違いにより収縮が異なりますのでご注意ください。

[参考例]

- 表地 TM-54014 (生地巾97cm)
- 裏地 TM-54419 (生地巾150cm)

形態安定縫製 サイズ 巾200cm × 丈200cm の場合

$$\begin{array}{l} 97\text{cm} \\ \text{表地の生地巾} \end{array} \times \begin{array}{l} 5\text{巾} \\ \text{表地の巾数} \end{array} \div \begin{array}{l} 150\text{cm} \\ \text{裏地の生地巾} \end{array} \doteq \begin{array}{l} 4\text{巾} \\ \text{裏地の巾数} \end{array} \quad (\text{小数点第1位切り上げ})$$

裏地付カーテンの価格は **¥104,300** (表地の価格) + **¥41,800** (裏地の価格) = **¥146,100** となります。

表地価格表

TM-54014

標準仕様		形態安定加工価格表 約2倍ヒダ (タッセル含む)							
H	W	~41 1巾(片開き)	~97 2巾	~145 3巾	~194 4巾	~242 5巾	~291 6巾	~339 7巾	~388 8巾
~100	15,800	30,900	44,800	57,800	70,900	84,700	97,800	111,600	
~120	15,800	30,900	44,800	57,800	70,900	84,700	97,800	111,600	
~140	19,100	37,400	54,500	70,900	88,000	104,300	121,500	137,700	
~160	19,100	37,400	54,500	70,900	88,000	104,300	121,500	137,700	
~180	22,400	44,800	64,400	84,700	104,300	124,800	145,100	164,700	
~200	22,400	44,800	64,400	84,700	104,300	124,800	145,100	164,700	
~220	25,600	51,200	74,900	97,800	121,500	145,100	167,900	191,600	
~240	25,600	51,200	74,900	97,800	121,500	145,100	167,900	191,600	
~260	28,900	57,800	84,700	111,600	137,700	164,700	191,600	218,500	
~280	28,900	57,800	84,700	111,600	137,700	164,700	191,600	218,500	
約1.5倍ヒダ	~53	~117	~194	~258	~323	~388	~452	~517	

※片開きはW270cmまで

裏地価格表

TM-54419

標準仕様		形態安定加工価格表 約2倍ヒダ (タッセルなし)						
H	W	~67 1巾(片開き)	~150 2巾	~225 3巾	~300 4巾	~375 5巾	~450 6巾	~525 7巾
~100	6,100	12,200	18,300	24,400	30,500	36,600	42,700	
~120	7,000	14,000	20,900	27,800	34,800	41,800	48,800	
~140	7,900	15,700	23,500	31,000	39,200	47,000	54,900	
~160	8,700	17,400	26,100	34,300	43,500	52,200	60,900	
~180	9,600	19,200	28,800	38,400	47,900	57,500	67,000	
~200	10,500	21,000	31,400	41,800	52,200	62,700	73,100	
~220	11,400	22,700	34,000	45,300	56,600	67,900	79,200	
~240	12,200	24,400	36,600	48,800	60,900	73,100	85,300	
~260	13,100	26,100	39,200	52,200	65,300	78,300	91,400	
~280	14,000	27,900	41,800	55,700	69,600	83,600	97,500	
約1.5倍ヒダ	~88	~200	~300	~400	~500			

※片開きはW270cmまで

ハトメカーテン上代算出方法 ※スタイルカーテンの掛率を適用してください。

① お選びいただいたカーテンのハトメカーテンの価格表をご覧ください。

② ご希望のハトメ内径をご確認ください。

A ハトメ内径38mmの場合、
仕上がり巾、丈の欄に掲載されている価格になります。

B ハトメ内径18mm または 26mmの場合、
仕上がり巾、丈の欄に掲載されている価格から、
それぞれの内径の欄に掲載されている価格を
差し引いた価格になります。 ※右記[参考例]参照

C ハトメ内径9mm または 46mmの場合、
最寄りの弊社営業所までお問合せください。

[参考例]

■品番 TM-54284
窓サイズ 巾100cm×丈220cm ハトメ内径26mm 片開きの場合

		ハトメカーテン 約1.8倍ヒダ					
38mm		(片開き/タッセルなし)					¥22,200 - ¥2,100 = ¥20,100
H	W	~72	~100	~127	~155	~183	
~100		14,700	16,800	24,200	26,300	31,500	となり
~140		16,500	18,600	26,800	28,900	35,100	
~180		18,300	20,400	29,500	31,600	38,700	
~220		20,100	22,200	32,200	34,300	42,200	¥20,100がハトメ26mmの時の
~260		21,900	24,000	34,900	37,000	45,800	価格になります。
~300		23,700	25,800	37,600	39,700	49,400	
26mm		-2,800	-2,100	-4,900	-4,200	-4,900	
18mm		-4,900	-5,600	-9,100	-9,800	-10,500	

※生地を伸ばした状態のサイズでご発注ください。

ハトメカーテンの発注方法

生地を伸ばした状態のサイズでご発注ください。

[参考例]

■品番 TM-54284 窓サイズ 巾200cm×丈200cm 約1.8倍ヒダの場合、巾200cm×ヒダ倍率1.8=360cm
巾360cm×丈200cmで寸法をご指示ください。

(所定の注文書の備考欄等に、「生地を伸ばした状態の寸法」など併せてご記入ください。)

ダブルシェード上代算出方法 ※スタイルカーテンの掛率を適用してください。

① ダブルシェードのスタイルおよび品番をお選びください。

② お選びいただいた前幕、後幕それぞれの価格表をご覧ください。 ※ドラム式・コード式をお間違えの無いようご注意ください。

③ ダブルシェードの上代は、以下の計算式で算出いたします。

$$\boxed{\text{前幕のシェードの上代}} + \boxed{\text{後幕のシェードの上代}} - \boxed{\text{¥5,000}} = \boxed{\text{ダブルシェードの上代}}$$

[参考例]

■ ダブルシェード (ブレン+ブレン) 65-54284 + 54344 (ドラム式1チェーン) 巾150cm×丈200cmの場合

前幕: ブレンシェード・ドラム式、品番 TM-54284

後幕: ブレンシェード・ドラム式、品番 TM-54344の価格表をご覧ください。

ブレンシェード価格表

TM-54284

		style no.60 ブレンシェード							
		ドラム式							
H	W	30~45	~90	~140	~190	~240	~290	~340	~390
50~100		15,000	19,000	25,500	29,500	36,000	43,200	49,900	54,700
~140		16,500	20,600	27,800	32,000	39,300	46,800	54,200	59,100
~180		17,900	22,100	30,200	34,000	42,600	50,100	58,200	63,300
~220		20,900	25,300	35,000	36,900	45,800	53,700	62,500	67,600
~260		20,900	25,300	35,000	39,300	49,100	57,000	66,800	71,800
~300		22,400	26,800	37,400	41,800	52,400	60,600	70,900	76,200

※ドラム式: 仕上り巾39cm以下の場合、仕上り丈は200cmまでとなります。

ブレンシェード価格表

TM-54344

		style no.60 ブレンシェード							
		ドラム式							
H	W	30~45	~90	~140	~190	~240	~290	~340	~390
50~100		15,600	19,700	24,200	28,300	35,400	42,600	47,400	52,200
~140		17,300	21,400	26,200	30,300	38,500	46,000	50,900	55,800
~180		19,000	23,200	28,200	32,000	41,600	49,100	54,100	59,100
~220		20,700	24,900	32,000	34,500	44,600	52,400	57,600	62,700
~260		22,300	26,700	32,100	36,500	47,700	55,600	61,000	66,000
~300		24,000	28,500	34,100	38,500	50,800	58,900	64,300	69,600

※ドラム式: 仕上り巾39cm以下の場合、仕上り丈は200cmまでとなります。

$$\boxed{\text{前幕のシェードの上代}} + \boxed{\text{後幕のシェードの上代}} - \boxed{\text{¥5,000}} = \boxed{\text{ダブルシェードの上代}}$$

¥36,900 + ¥34,500 - ¥5,000 = ¥66,400 となります。

Lineview kioi インクジェットプリント

- 「ラインビューkioiインクジェットコレクション」は、カスタムオーダーでカラー・柄スケールの変更が可能です。
- 裾カット・巾継ぎ・巾落とし等の加工は別途加工費が掛かります。

受注生産
特殊掛率

納期：受注後 約3～4週間

- ポリエステル100%
 - 取扱い表示
 - 防炎(イ)ラベル
- (日本製)
洗濯ネット使用

■ STR71 菊松葉尽くし

- 基本柄デザイン(一部)
※左右に柄は繋がりません
- 柄サイズ
タテ 2850mm
ヨコ 950mm

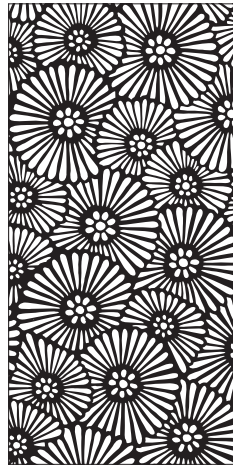

■ STR72 野の草花文様

- 基本柄デザイン(一部)
※左右に柄は繋がりません
- 柄サイズ
タテ 2850mm
ヨコ 950mm

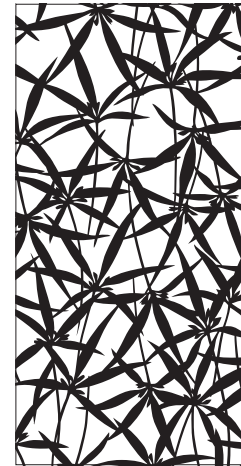

価格表 12ゲージ(1インチ間に12本)

	1枚	6枚以上
W1000×H3000mm	¥58,000	¥55,000 / 枚
W1000×H4000mm	¥65,000	¥62,000 / 枚
巾継ぎ・巾落とし	¥1,000 / ヶ所	
裾カット	¥1,000 / m ※1m単位、切上げ	

Lineview オリジナルデータ インクジェットプリント

- お客様がお持ちのデザインデータなど、オリジナルデザインを出力できます。
- イラストレータ・フォトショップなどのデータをご用意いただき、リリカラ営業担当者までお問い合わせください。

- 入稿データは上部の帯部分(約15cm)と下部約1cm、左右の余裕(それぞれ約1cm)を含めたサイズで製作してください。
- オリジナルデータの出力は、データ編集費・試作費等が発生する場合がありますため、別途お見積りいたします。詳しくはリリカラ営業担当者までお問い合わせください。

推奨データ形式 	Illustrator (ai / イラストレーター) ※文字フォントは必ずアウトライン化してください。 Photoshop (psd / フォトショップ) JPEG (jpg / ジェイベグ) ※72dpi以上推奨、実寸サイズでの入稿をお願いいたします。
データ変換が必要	写真(ネガ・ポジを含む) ※データ変換の場合は、別途データ加工費用が発生します。
取扱い不可	雑誌の切り抜き・書籍雑誌・書籍は、肖像権・著作権が発生するため、データ化ができません。

オーダーカーテンご注文方法

1. カーテン生地の商品番号をご指定ください。
2. 仕上りサイズは巾(W)×丈(H)を10mm単位でカン下寸法にてご指定ください。
3. 開閉(両開き、片開き右寄せ、片開き左寄せ)をご指定ください。
4. 取付け方法(A・天井付、B・正面付)をご指定ください。
5. 窓数をご指定ください。
6. タッセルの総本数をご指定ください。
7. 防炎ラベル(有償)の縫い付けが必要な場合はご指定ください。

カーテンの採寸方法

せっかくの新しいカーテンも、寸足らずだったり、床を引きずるほど長かったりしては、お部屋の雰囲気を台無しにしてしまいます。お届け後に多少の調整が可能な部分もありますが、以下の方法で正しい仕上りサイズと取付け方法をご指定ください。

■ サイズの測り方

サイズは必ずレールを取付けた状態で測ります。

- 仕上り巾<レールの巾そのものの長さ(ゆとりをもたせたい場合はレールの巾の長さに3%たしててください。)>
 - 仕上り丈<腰窓>—ランナーの穴の下端から窓枠より20cmほど下までの長さ
 - 仕上り丈<掃き出し窓>—ランナーの穴の下端から床より1cmほど上までの長さ
- ※ドレープとレースの二重吊りではドレープの丈を上記の長さとし、レースの丈をそれより1cmほど短くします。

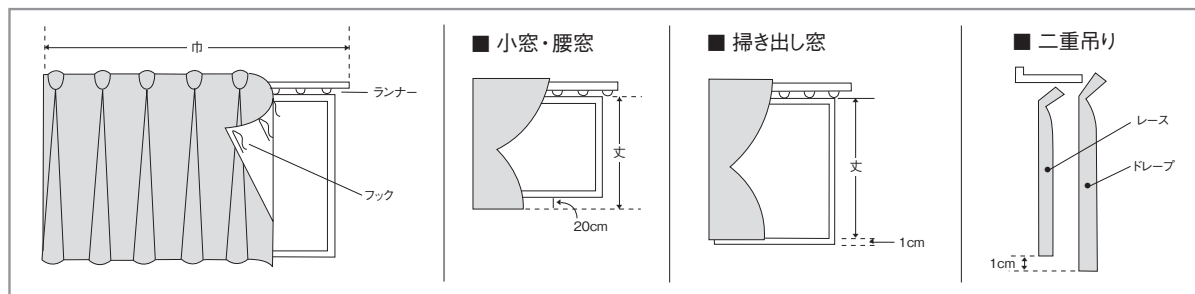

■ 取付け方法の指定

レールの種類とその取付け面によってカーテン上部の仕上げが異なります。

下図の該当するものを参照し、誤りのないようご指定ください。

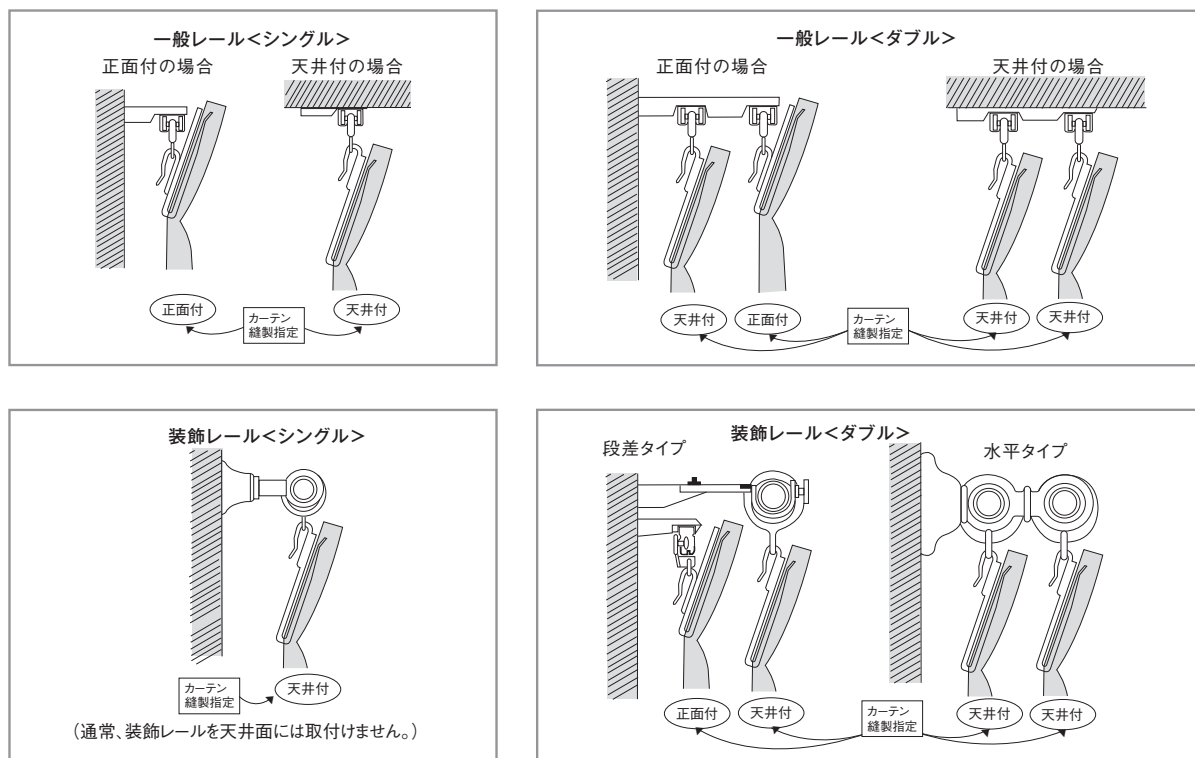

PRICE LIST

品番別価格表

TM-54001・54002



巾 ◇ 300cm ヨコ使い 価格 ◇ 9,000円/m リポート ◇ タテ300.0cm ヨコ22.0cm 取扱い表示 ◇ リ-30 40 炎 窓 1 2 3 4 5 6 7 8 9 10 11 12 13 14 15 16 17 18 19 20 21 22 23 24 25 26 27 28 29 30 31 32 33 34 35 36 37 38 39 40 41 42 43 44 45 46 47 48 49 50 51 52 53 54 55 56 57 58 59 60 61 62 63 64 65 66 67 68 69 70 71 72 73 74 75 76 77 78 79 80 81 82 83 84 85 86 87 88 89 90 91 92 93 94 95 96 97 98 99 100
 組成 ◇ ポリエステル100% 寸法変化率 ◇ 水洗い/タテ -0.2% ヨコ 0.0% 防炎性能 ◇ -
 ドライ/タテ -0.5% ヨコ 0.0% Made in Turkey

モダン

H	W	~50	~100	~150	~200	~250	~300	~350	~400
		(片開き)							
~100	11,700	22,400	33,100	43,800	54,500	65,100	75,800	86,500	
~120	12,100	23,000	33,900	44,900	55,800	66,700	77,600	88,500	
~140	12,300	23,500	34,700	45,800	57,000	68,100	79,300	90,500	
~160	12,600	24,000	35,400	46,800	58,200	69,600	81,000	92,400	
~180	12,800	24,500	36,100	47,700	59,400	71,000	82,700	94,300	
~200	13,100	24,900	36,800	48,700	60,600	72,500	84,300	96,200	
~220	13,400	25,500	37,700	49,800	61,900	74,000	86,100	98,300	
~240	13,700	26,000	38,400	50,700	63,100	75,500	87,800	100,200	
~260	13,900	26,500	39,100	51,700	64,300	76,900	89,500	102,100	
約1.5倍ヒダ	~60	~120	~200	~266	~333	~400	~466	~533	
フラット前ヒダ	~90	~160	~260	~360	~460	~560			

H	W	~50	~100	~150	~200	~250	~300	~350	~400
		(片開き)							
~100	12,300	23,600	34,800	46,100	57,300	68,500	79,800	91,000	
~120	12,800	24,400	35,900	47,500	59,100	70,600	82,200	93,700	
~140	13,100	25,000	36,900	48,800	60,700	72,500	84,400	96,300	
~160	13,500	25,700	37,900	50,100	62,300	74,500	86,700	98,900	
~180	13,800	26,300	38,800	51,300	63,900	76,400	88,900	101,400	
~200	14,100	26,900	39,800	52,600	65,500	78,300	91,100	104,000	
~220	14,600	27,700	40,900	54,100	67,200	80,400	93,500	106,700	
~240	14,900	28,400	41,900	55,300	68,800	82,300	95,800	109,300	
~260	15,200	29,000	42,800	56,600	70,400	84,200	98,000	111,800	
~280	15,200	29,000	42,800	56,600	70,400	84,200	98,000	111,800	
約1.5倍ヒダ	~60	~120	~200	~266	~333	~400	~466	~533	
フラット前ヒダ	~90	~160	~260	~360	~460	~560			

H	W	~50	~100	~150	~200	~250	~300	~350	~400
		(片開き)							
~100	12,000	23,000	34,000	44,900	55,900	66,800	77,800	88,800	
~120	12,500	23,700	34,900	46,200	57,400	68,700	79,900	91,100	
~140	12,700	24,300	35,800	47,300	58,800	70,300	81,900	93,400	
~160	13,000	24,800	36,600	48,400	60,200	72,000	83,800	95,600	
~180	13,300	25,400	37,500	49,500	61,600	73,700	85,800	97,900	
~200	13,600	25,900	38,300	50,700	63,000	75,400	87,700	100,100	
~220	14,000	26,600	39,300	51,900	64,600	77,200	89,800	102,500	
~240	14,300	27,200	40,100	53,000	66,000	78,900	91,800	104,700	
~260	14,600	27,800	41,000	54,200	67,400	80,600	93,800	107,000	
約1.5倍ヒダ	~60	~120	~200	~266	~333	~400	~466	~533	

H	W	~50	~100	~150	~200	~250	~300	~350	~400
		(片開き)							
~100	12,600	24,200	35,700	47,200	58,700	70,200	81,800	93,300	
~120	13,200	25,100	36,900	48,800	60,700	72,600	84,500	96,300	
~140	13,500	25,800	38,000	50,300	62,500	74,700	87,000	99,200	
~160	13,900	26,500	39,100	51,700	64,300	76,900	89,500	102,100	
~180	14,300	27,200	40,200	53,100	66,100	79,100	92,000	105,000	
~200	14,600	27,900	41,300	54,600	67,900	81,200	94,500	107,900	
~220	15,200	28,800	42,500	56,200	69,900	83,600	97,200	110,900	
~240	15,500	29,600	43,600	57,600	71,700	85,700	99,800	113,800	
~260	15,900	30,300	44,700	59,100	73,500	87,900	102,300	116,700	
~280	15,900	30,300	44,700	59,100	73,500	87,900	102,300	116,700	
約1.5倍ヒダ	~60	~120	~200	~266	~333	~400	~466	~533	

H	W	~50	~100	~150	~200	~250	~300	~350	~400
		(片開き)							
~100	12,300	23,600	34,800	46,100	57,300	68,500	79,800	91,000	
~120	12,800	24,400	35,900	47,500	59,100	70,600	82,200	93,700	
~140	13,100	25,000	36,900	48,800	60,700	72,500	84,400	96,300	
~160	13,500	25,700	37,900	50,100	62,300	74,500	86,700	98,900	
~180	13,800	26,300	38,800	51,300	63,900	76,400	88,900	101,400	
~200	14,100	26,900	39,800	52,600	65,500	78,300	91,100	104,000	
~220	14,600	27,700	40,900	54,100	67,200	80,400	93,500	106,700	
~240	14,900	28,400	41,900	55,300	68,800	82,300	95,800	109,300	
~260	15,200	29,000	42,800	56,600	70,400	84,200	98,000	111,800	
約1.5倍ヒダ	~60	~120	~200	~266	~333	~400	~466	~533	

H	W	~50	~100	~150	~200	~250	~300	~350	~400
		(片開き)							
~100	12,900	24,700	36,500	48,300	60,100	71,900	83,700	95,500	
~120	13,500	25,700	37,900	50,100	62,300	74,500	86,700	98,900	
~140	13,900	26,500	39,100	51,700	64,300	76,900	89,500	102,100	
~160	14,300	27,300	40,300	53,300	66,300	79,300	92,300	105,300	
~180	14,700	28,100	41,500	54,900	68,300	81,700	95,100	108,500	
~200	15,100	28,900	42,700	56,500	70,300	84,100	97,900	111,700	
~220	15,700	29,900	44,100	58,300	72,500	86,700	100,900	115,100	
~240	16,100	30,700	45,300	59,900	74,500	89,100	103,700	118,300	
~260	16,500	31,500	46,500	61,500	76,500	91,500	106,500	121,500	
約1.5倍ヒダ	~60	~120	~200	~266	~333	~400	~466	~533	

		コード式					ドラム式							
H	W	30~45	~90	~140	~190	~240	30~45	~90	~140	~190	~240	~290	~340	~390
50~100	33,800	37,400	42,000	45,600	50,300	36,800	40,400	45,000	48,600	53,300	60,900	88,900	93,700	
~140	34,700	38,400	43,100	46,800	51,800	37,700	41,400	46,100	49,800	54,800	62,600	90,700	95,600	
~180	35,500	39,200	44,300	48,100	53,200	38,500	42,200	47,300	51,100	56,200	64,100	92,300	97,300	
~220	36,400	40,200	45,400	49,300	54,600	39,400	43,200	48,400	52,300	57,600	65,800	94,100	99,200	
~260	37,200	41,100	46,600	50,500	56,100	40,200	44,100	49,600	53,500	59,100	67,200	95,900	100,900	
~280	38,000	42,100	47,700	51,800	57,600	41,000	45,100	50,700	54,800	60,600	69,000	97,500	102,900	

		コード式
H	W	18~30
50~100	36,600	
~140	38,100	
~180	39,100	
~220	40,600	
~240	41,600	

		コード式					ドラム式							
スラッグ数	W	1S	2S	3S	4S	5S	1S	2S	3S	4S	5S	6S	7S	8S
100~140	36~50	~100	~150	~200	~250	29,500	47,000	65,500	83,900	104,000	124,300	144,500	164,600	
~180	28,500	46,800	66,100	85,500	106,800	31,500	49,800	69,100	88,500	109,800	131,100	152,400	173,800	
~220	30,600	49,600	69,900	90,100	112,600	33,600	52,600	72,900	93,100	115,600	137,800	160,400	182,900	
~260	31,800	52,400	73,500	94,700	118,400	34,800	55,400	76,500	97,700	121,400	144,600	168,300	188,000	
~280	34,700	55,200	77,300	99,300	124,200	37,700	58,200	80,300	102,300	127,200	151,300	176,200	201,100	

※ 出窓の場合はコーナー1ヶ所につきコード式は3,500円、ドラム式は4,500円プラスになります。

TM-54004~54007

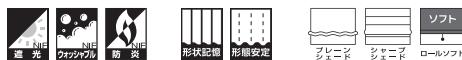

巾 ◇ 150cm 価格 ◇ 5,700円/m リポート ◇ タテ 24.5cm ヨコ 15.0cm 取扱い表示 ◇ リ-30 防炎性能 ◇ (イ) であって使用
 組成 ◇ ポリエステル100% 寸法変化率 ◇ 水洗い/タテ -0.7% ヨコ -0.7% ドライ/タテ -0.9% ヨコ -0.2% Made in Japan

モダン

標準仕様 形態安定加工価格表 約2倍ヒダ (タッセル含む)

H	W	~67	~150	~225	~300	~375	~450	~525
		1巾(片開き)	2巾	3巾	4巾	5巾	6巾	7巾
~100		13,600	26,900	38,700	49,600	61,200	73,000	83,900
~120		15,800	30,900	44,100	57,400	70,600	83,900	97,100
~140		17,400	34,700	49,600	65,200	80,000	95,600	111,200
~160		18,900	38,700	55,900	73,000	90,200	107,300	124,500
~180		18,900	38,700	55,900	73,000	90,200	107,300	124,500
~200		21,400	41,800	61,200	80,000	99,500	118,300	137,700
~220		22,900	45,600	66,800	87,800	108,900	129,900	151,000
~240		25,200	49,600	73,000	95,600	118,300	141,700	164,200
~260		26,700	53,400	78,400	103,400	128,300	153,300	177,500
~280		26,700	53,400	78,400	103,400	128,300	153,300	177,500
約1.5倍ヒダ		~88	~200	~300	~400	~500		

※片開きはW270cmまで

プライム縫製仕様価格表 約2倍ヒダ (タッセル含む)

H	W	~67	~150	~225	~300	~375	~450	~525
		1巾(片開き)	2巾	3巾	4巾	5巾	6巾	7巾
~100		14,000	27,800	40,100	51,400	63,500	75,700	87,000
~120		16,400	32,000	45,600	59,500	73,200	87,000	100,700
~140		18,000	35,900	51,400	67,600	82,900	99,100	115,300
~160		19,600	40,100	57,900	75,700	93,500	111,300	129,200
~180		19,600	40,100	57,900	75,700	93,500	111,300	129,200
~200		22,100	43,300	63,500	82,900	103,200	122,700	142,800
~220		23,700	47,300	69,200	91,000	113,000	134,700	156,700
~240		26,100	51,400	75,700	99,100	122,700	147,000	170,400
~260		27,700	55,400	81,300	107,200	133,100	159,000	184,200
~280		27,700	55,400	81,300	107,200	133,100	159,000	184,200
約1.5倍ヒダ		~88	~200	~300	~400	~500		

※片開きはW270cmまで

レギュラー縫製仕様価格表 約2倍ヒダ (タッセル含む)

H	W	~67	~150	~225	~300	~375	~450	~525	~600
		1巾(片開き)	2巾	3巾	4巾	5巾	6巾	7巾	8巾
~100		13,100	26,000	37,300	47,800	59,000	70,300	80,800	92,000
~120		15,300	29,800	42,500	55,300	68,000	80,800	93,500	107,000
~140		16,800	33,500	47,800	62,800	77,000	92,000	107,000	121,300
~160		18,300	37,300	53,800	70,300	86,800	103,300	119,800	136,300
~180		18,300	37,300	53,800	70,300	86,800	103,300	119,800	136,300
~200		20,600	40,300	59,000	77,000	95,800	113,800	132,500	150,500
~220		22,100	44,000	64,300	84,500	104,800	125,000	145,300	165,500
~240		24,300	47,800	70,300	92,000	113,800	136,300	158,000	180,500
~260		25,800	51,500	75,500	99,500	123,500	147,500	170,800	194,800
~280		25,800	51,500	75,500	99,500	123,500	147,500	170,800	194,800
約1.5倍ヒダ		~88	~200	~300	~400	~500	~600	~700	~800
フラット約1倍ヒダ		~130	~260	~410	~560				

形状記憶加工価格表 約2倍ヒダ (タッセル含む)

H	W	~67	~150	~225	~300	~375	~450	~525	~600
		1巾(片開き)	2巾	3巾	4巾	5巾	6巾	7巾	8巾
~100		14,900	29,600	42,800	55,000	67,900	81,100	93,200	106,200
~120		17,400	34,100	48,800	63,700	78,300	93,200	107,900	123,600
~140		19,200	38,300	55,000	72,400	88,800	106,200	123,600	140,200
~160		20,900	42,800	61,900	81,100	100,200	119,300	138,500	157,600
~180		20,900	42,800	61,900	81,100	100,200	119,300	138,500	157,600
~200		23,600	46,300	67,900	88,800	110,600	131,500	153,200	174,000
~220		25,400	50,500	74,100	97,500	121,100	144,500	168,100	191,400
~240		27,900	55,000	81,100	106,200	131,500	157,600	182,700	208,800
~260		29,600	59,200	87,000	114,900	142,700	170,600	197,600	225,500

※片開きはW300cmまで

style no.60 プレーンシェード

H	W	コード式					ドラム式							
		30~45	~90	~140	~190	~240	30~45	~90	~140	~190	~240	~290	~340	~390
50~100		16,600	20,600	25,100	34,900	39,600	19,600	23,600	28,100	37,900	42,600	49,900	60,600	65,400
~140		20,000	24,000	28,700	40,900	45,800	23,000	27,000	31,700	43,900	48,800	56,500	69,800	74,700
~180		22,800	26,800	31,800	46,900	52,000	25,800	29,800	34,800	49,900	55,000	62,900	78,700	83,700
~220		25,200	29,200	34,500	50,100	55,400	28,200	32,200	37,500	53,100	58,400	66,600	83,900	89,100
~260		28,500	32,600	38,000	56,100	61,600	31,500	35,600	41,000	59,100	64,600	72,900	93,100	98,100
~300		30,300	34,600	40,200	59,700	65,500	33,300	37,600	43,200	62,700	68,500	77,100	98,100	103,500

※ドラム式: 仕上り巾39cm以下の場合、仕上り巾は200cmまでとなります。

style no.63 シャープシェード

H	W	コード式					ドラム式							
		30~45	~90	~140	~190	~240	30~45	~90	~140	~190	~240	~290	~340	~390
50~100		19,400	25,700	32,300	45,100	51,400	22,400	28,700	35,300	48,100	54,400	62,600	75,300	81,900
~140		23,000	29,700	36,800	52,600	59,500	26,000	32,700	39,800	55,600	62,500	71,100	86,700	93,600
~180		26,100	33,200	40,800	60,600	67,700	29,100	36,200	43,800	63,100	70,700	79,600	98,400	105,700
~220		28,700	36,200	44,300	64,600	72,700	31,700	39,200	47,300	67,600	75,700	85,000	105,500	113,100
~260		32,400	40,600	49,200	72,700	81,500	35,400	43,600	52,200	75,700	84,500	94,300	117,800	126,000
~300		34,600	43,300	52,600	78,200	87,800	37,600	46,300	55,600	81,200	90,800	101,000	126,100	134,800

※ドラム式: 仕上り巾39cm以下の場合、仕上り巾は200cmまでとなります。

形態安定加工 推奨裏地付価格表(推奨裏地 TM-54419~54423) 約2倍ヒダ (タッセル含む)

H	W	~67	~150	~225	~300	~375	~450	~525
		1巾(片開き)	2巾	3巾	4巾	5巾	6巾	7巾
~100		19,700	39,100	57,000	74,000	91,700	109,600	126,600
~120		22,800	44,900	65,000	85,300	105,400	125,700	145,900
~140		25,300	50,400	73,100	96,600	119,200	142,600	166,100
~160		27,600	56,100	82,000	107,800	133,700	159,500	185,400
~180		28,500	57,900	84,700	111,300	138,100	164,800	191,500
~200		31,900	62,700	92,600	121,800	151,700	181,000	210,800
~220		34,300	68,300	100,800	133,100	165,500	197,800	230,200
~240		37,400	74,000	109,600	144,400	179,200	214,800	249,500
~260		39,800	79,500	117,600	155,600	193,600	231,600	268,900
~280		40,700	81,300	120,200	159,100	197,900	236,900	275,000
約1.5倍ヒダ		~88	~200	~300	~400	~500		

※片開きはW270cmまで

プライム縫製仕様 推奨裏地付価格表(推奨裏地 TM-54419~54423) 約2倍ヒダ (タッセル含む)

H	W	~67	~150	~225	~300	~375	~450	~525
		1巾(片開き)	2巾	3巾	4巾	5巾	6巾	7巾
~100		20,600	40,900	59,700	77,500	96,100	114,800	132,600
~120		23,900	46,900	68,000	89,300	110,400	131,700	152,800
~140		26,400	52,700	76,600	101,100	124,800	149,400	173,900
~160		28,900	58,700	85,800	112,900	140,000	167,100	194,300
~180		29,900	60,600	88,600	116,700	144,700	172,700	200,900
~200		33,300	65,700	97,000	127,600	159,000	189,700	221,000
~220		35,800	71,500	105,500	139,400	173,500	207,300	241,400
~240		39,200	77,500	114,800	151,200	187,800	225,200	261,600
~260		41,700	83,300	123,200	163,000	202,900	242,700	281,900
~280		42,600	85,200	126,000	166,800	207,500	248,300	288,400
約1.5倍ヒダ		~88	~200	~300	~400	~500		

※片開きはW270cmまで

レギュラー縫製仕様 推奨裏地付価格表(推奨裏地 TM-54419~54423) 約2倍ヒダ (タッセル含む)

H	W	~67	~150	~225	~300	~375	~450	~525	~600
		1巾(片開き)	2巾	3巾	4巾	5巾	6巾	7巾	8巾
~100		18,800	37,400	54,400	70,500	87,400	104,400	120,500	137,400
~120		21,800	42,800	62,000	81,300	100,400	119,700	138,900	158,900
~140		24,100	48,100	69,700	92,000	113,500	135,800	158,100	179,700
~160		26,400	53,500	78,100	102,700	127,300	151,900	176,500	201,100
~180		27,300	55,200	80,600	106,000	131,400	156,800	182,200	207,600
~200		30,400	59,800	88,200	115,900	144,400	172,200	200,600	228,300
~220</									

TM-54008・54009



巾 ◇ 148cm 価格 ◇ 6,700円/m
組成 ◇ ポリエステル100%

リポート ◇ タテ 45.8cm ヨコ 29.7cm
寸法変化率 ◇ 水洗い/タテ -0.2% ヨコ 0.0%
ドライ/タテ -0.5% ヨコ 0.0%

取扱い表示 ◇ リ-30
防炎性能 ◇ (イ)
Made in Japan

H	W	~65 1巾(片開き)	~148 2巾	~222 3巾	~296 4巾	~370 5巾	~444 6巾	~518 7巾
~100		14,300	28,400	40,700	52,100	64,400	76,800	89,100
~120		18,600	36,400	52,100	68,900	84,600	100,400	117,100
~140		18,600	36,400	52,100	68,900	84,600	100,400	117,100
~160		22,200	44,300	64,400	84,600	104,800	124,900	145,100
~180		22,200	44,300	64,400	84,600	104,800	124,900	145,100
~200		26,500	52,100	76,800	100,400	124,900	148,600	173,300
~220		26,500	52,100	76,800	100,400	124,900	148,600	173,300
~240		30,000	60,900	89,100	117,100	145,100	173,300	201,300
~260		30,000	60,900	89,100	117,100	145,100	173,300	201,300
~280		30,000	60,900	89,100	117,100	145,100	173,300	201,300
約1.5倍ヒダ		~86	~192	~296	~394	~493		

※片開きはW270cmまで

H	W	~65 1巾(片開き)	~148 2巾	~222 3巾	~296 4巾	~370 5巾	~444 6巾	~518 7巾
~100		14,700	29,200	42,000	53,700	66,500	79,200	92,000
~120		19,200	37,500	53,700	71,100	87,300	103,700	120,900
~140		19,200	37,500	53,700	71,100	87,300	103,700	120,900
~160		22,800	45,600	66,500	87,300	108,200	129,000	149,900
~180		22,800	45,600	66,500	87,300	108,200	129,000	149,900
~200		27,300	53,700	79,200	103,700	129,000	153,500	179,000
~220		27,300	53,700	79,200	103,700	129,000	153,500	179,000
~240		30,900	62,800	92,000	120,900	149,900	179,000	208,000
~260		30,900	62,800	92,000	120,900	149,900	179,000	208,000
~280		30,900	62,800	92,000	120,900	149,900	179,000	208,000
約1.5倍ヒダ		~86	~192	~296	~394	~493		

※片開きはW270cmまで

H	W	~65 1巾(片開き)	~148 2巾	~222 3巾	~296 4巾	~370 5巾	~444 6巾	~518 7巾	~592 8巾
~100		13,900	27,600	39,500	50,500	62,400	74,300	86,200	97,200
~120		18,100	35,300	50,500	66,700	81,900	97,200	113,300	128,600
~140		18,100	35,300	50,500	66,700	81,900	97,200	113,300	128,600
~160		21,500	42,900	62,400	81,900	101,400	120,900	140,400	159,800
~180		21,500	42,900	62,400	81,900	101,400	120,900	140,400	159,800
~200		25,700	50,500	74,300	97,200	120,900	143,800	167,600	190,400
~220		25,700	50,500	74,300	97,200	120,900	143,800	167,600	190,400
~240		29,100	59,000	86,200	113,300	140,400	167,600	194,600	221,700
~260		29,100	59,000	86,200	113,300	140,400	167,600	194,600	221,700
~280		29,100	59,000	86,200	113,300	140,400	167,600	194,600	221,700
約1.5倍ヒダ		~86	~192	~296	~394	~493	~592	~690	~789
フラット前ヒダ		~128	~256	~404	~552				

H	W	~65 1巾(片開き)	~148 2巾	~222 3巾	~296 4巾	~370 5巾	~444 6巾	~518 7巾	~592 8巾
~100		15,600	30,900	44,500	57,000	70,600	84,100	97,700	110,200
~120		20,300	39,700	57,000	75,500	92,800	110,200	128,600	146,000
~140		20,300	39,700	57,000	75,500	92,800	110,200	128,600	146,000
~160		24,200	48,300	70,600	92,800	115,000	137,200	159,400	181,600
~180		24,200	48,300	70,600	92,800	115,000	137,200	159,400	181,600
~200		28,900	57,000	84,100	110,200	137,200	163,300	190,400	216,500
~220		28,900	57,000	84,100	110,200	137,200	163,300	190,400	216,500
~240		32,800	66,700	97,700	128,600	159,400	190,400	221,300	252,100
~260		32,800	66,700	97,700	128,600	159,400	190,400	221,300	252,100

※片開きはW300cmまで

		コード式				ドラム式								
H	W	30~45	~90	~140	~190	~240	30~45	~90	~140	~190	~240	~290	~340	~390
50~100		18,300	22,300	34,900	38,700	43,300	21,300	25,300	37,900	41,700	46,300	61,800	66,600	71,400
~140		22,100	26,100	41,200	45,000	49,900	25,100	29,100	44,200	48,000	52,900	71,100	76,000	80,900
~180		25,300	29,300	47,500	51,300	56,400	28,300	32,300	50,500	54,300	59,400	80,600	85,600	90,600
~220		29,100	33,100	53,900	57,600	62,900	32,100	36,100	56,900	60,600	65,900	90,400	95,500	100,600
~260		32,300	36,400	60,800	64,400	70,000	35,300	39,400	63,800	67,400	73,000	99,900	105,400	110,400
~300		33,200	37,300	61,900	65,700	71,500	36,200	40,300	64,900	68,700	74,500	101,600	107,000	112,300

※ドラム式: 仕上り巾39cm以下の場合、仕上り丈は200cmまでとなります。

		コード式	
H	W	18~30	
50~100		18~30	22,600
~140			26,700
~180			29,900
~220			34,100
~240			35,100

		コード式				ドラム式								
H	W	30~45	~90	~140	~190	~240	30~45	~90	~140	~190	~240	~290	~340	~390
50~100		21,200	27,400	42,500	49,100	55,500	24,200	30,400	45,500	52,100	58,500	75,100	81,700	88,200
~140		25,200	31,900	49,900	56,900	63,900	28,200	34,900	52,900	59,900	66,900	86,300	93,200	100,100
~180		28,700	35,800	57,200	64,800	72,300	31,700	38,800	60,200	67,800	75,300	98,100	105,600	112,900
~220		32,800	40,300	64,600	72,600	80,800	35,800	43,300	67,600	75,600	83,800	109,900	117,600	125,200
~260		36,300	44,500	73,000	81,600	90,500	39,300	47,500	76,000	84,600	93,500	122,500	130,700	138,800
~300		37,500	46,200	75,400	84,600	94,100	40,500	49,200	78,400	87,600	97,100	126,700	135,400	144,000

※ドラム式: 仕上り巾39cm以下の場合、仕上り丈は200cmまでとなります。

		38mm (片開き/タッセルなし)					
H	W	~72	~100	~127	~155	~183	
~100		17,600	28,800	33,000	35,100	46,400	
~140		20,900	34,800	39,000	41,100	54,900	
~180		23,500	40,600	44,800	46,900	64,100	
~220		26,700	46,500	50,700	52,800	73,300	
~260		29,400	53,100	57,300	59,400	82,500	
~300		32,700	59,000	63,200	65,300	90,900	
26mm		-2,800	-2,100	-4,900	-4,200	-4,900	
18mm		-4,900	-5,600	-9,100	-9,800	-10,500	

※生地を伸ばした状態のサイズでご発注ください。

		スプリング・チェーンタイプ				
H	W	30~60	~80	~100	~120	~138
50~80		33,400	35,900	37,900	39,100	40,800
~120		37,100	40,200	42,200	43,300	45,200
~160		40,400	44,200	46,200	47,400	48,700
~200		45,300	48,300	50,500	51,700	53,000
~240			52,000	54,300	55,500	56,900

※丈は巾の3倍までが限度です。
※ロールソフト加工品は非防災品になります。

		ストレートバランス				
H	W	~100	~150	~200	~250	~300
~40		14,200	23,400	27,800	32,200	41,500

※マジックテープ仕様・裏面スポンジ付の価格になります。

H	W	~100	~150	~200	~250	~300
~40		14,300	20,700	27,000	34,300	35,800

※マジックテープ仕様の価格になります。

モダン

TM-54012・54013



巾 ◇ 100cm 価格 ◇ 6,700円/m
組成 ◇ ポリエステル100%

リポート ◇ タテ49.5cm ヨコ33.3cm
寸法変化率 ◇ 水洗い/タテ 0.0% ヨコ 0.0%
ドライ/タテ 0.0% ヨコ 0.0%

取扱い表示 ◇ リ-30
防炎性能 ◇ (イ)
Made in Japan

H	W	~44 1巾(片開き)	~100 2巾	~150 3巾	~200 4巾	~250 5巾	~300 6巾	~350 7巾	~400 8巾
~100		14,100	28,200	40,400	52,500	64,700	76,800	88,200	100,300
~120		18,200	36,300	52,500	68,700	84,100	100,300	116,500	132,700
~140		18,200	36,300	52,500	68,700	84,100	100,300	116,500	132,700
~160		18,200	36,300	52,500	68,700	84,100	100,300	116,500	132,700
~180		22,200	44,400	64,700	84,100	104,400	124,600	144,900	164,300
~200		22,200	44,400	64,700	84,100	104,400	124,600	144,900	164,300
~220		26,300	52,500	76,800	100,300	124,600	148,900	172,400	196,700
~240		26,300	52,500	76,800	100,300	124,600	148,900	172,400	196,700
~260		26,300	52,500	76,800	100,300	124,600	148,900	172,400	196,700
~280		30,300	60,600	88,200	116,500	144,900	172,400	200,800	229,100
約1.5倍ヒダ		~56	~120	~200	~266	~333	~400	~466	~533

※片開きはW270cmまで

H	W	~44 1巾(片開き)	~100 2巾	~150 3巾	~200 4巾	~250 5巾	~300 6巾	~350 7巾	~400 8巾
~100		14,400	28,800	41,300	53,700	66,200	78,600	90,200	102,700
~120		18,600	37,100	53,700	70,300	86,100	102,700	119,300	135,900
~140		18,600	37,100	53,700	70,300	86,100	102,700	119,300	135,900
~160		18,600	37,100	53,700	70,300	86,100	102,700	119,300	135,900
~180		22,700	45,400	66,200	86,100	106,800	127,600	148,300	168,300
~200		22,700	45,400	66,200	86,100	106,800	127,600	148,300	168,300
~220		26,900	53,700	78,600	102,700	127,600	152,500	176,600	201,500
~240		26,900	53,700	78,600	102,700	127,600	152,500	176,600	201,500
~260		26,900	53,700	78,600	102,700	127,600	152,500	176,600	201,500
~280		31,000	62,000	90,200	119,300	148,300	176,600	205,600	234,700
約1.5倍ヒダ		~56	~120	~200	~266	~333	~400	~466	~533

※片開きはW270cmまで

H	W	~44 1巾(片開き)	~100 2巾	~150 3巾	~200 4巾	~250 5巾	~300 6巾	~350 7巾	~400 8巾
~100		13,800	27,600	39,500	51,300	63,200	75,000	86,100	97,900
~120		17,800	35,500	51,300	67,100	82,100	97,900	113,700	129,500
~140		17,800	35,500	51,300	67,100	82,100	97,900	113,700	129,500
~160		17,800	35,500	51,300	67,100	82,100	97,900	113,700	129,500
~180		21,700	43,400	63,200	82,100	101,900	121,600	141,400	160,300
~200		21,700	43,400	63,200	82,100	101,900	121,600	141,400	160,300
~220		25,700	51,300	75,000	97,900	121,600	145,300	168,200	191,900
~240		25,700	51,300	75,000	97,900	121,600	145,300	168,200	191,900
~260		25,700	51,300	75,000	97,900	121,600	145,300	168,200	191,900
~280		29,600	59,200	86,100	113,700	141,400	168,200	195,900	223,500
約1.5倍ヒダ		~56	~120	~200	~266	~333	~400	~466	~533
フラット前ヒダ		~80	~160	~260	~360	~460	~560		

H	W	~44 1巾(片開き)	~100 2巾	~150 3巾	~200 4巾	~250 5巾	~300 6巾	~350 7巾	~400 8巾
~100		15,000	30,000	43,100	56,100	69,200	82,200	94,400	107,500
~120		19,400	38,700	56,100	73,500	90,100	107,500	124,900	142,300
~140		19,400	38,700	56,100	73,500	90,100	107,500	124,900	142,300
~160		19,400	38,700	56,100	73,500	90,100	107,500	124,900	142,300
~180		23,700	47,400	69,200	90,100	111,800	133,600	155,300	176,200
~200		23,700	47,400	69,200	90,100	111,800	133,600	155,300	176,200
~220		28,100	56,100	82,200	107,500	133,600	159,700	184,900	211,000
~240		28,100	56,100	82,200	107,500	133,600	159,700	184,900	211,000
~260		28,100	56,100	82,200	107,500	133,600	159,700	184,900	211,000

※片開きはW300cmまで

		コード式				ドラム式								
H	W	30~45	~90	~140	~190	~240	30~45	~90	~140	~190	~240	~290	~340	~390
50~100		18,900	22,800	36,000	39,800	52,900	21,900	25,800	39,000	42,800	55,900	63,600	77,000	81,800
~140		22,700	26,700	42,900	46,700	62,900	25,700	29,700	45,900	49,700	65,900	73,900	90,400	95,300
~180		23,500	27,600	44,100	47,900	64,300	26,500	30,600	47,100	50,900	67,300	75,400	92,000	97,000
~220		27,400	31,400	51,000	54,800	74,200	30,400	34,400	54,000	57,800	77,200	85,700	104,700	109,800
~260		31,100	35,200	57,900	61,600	84,000	34,100	38,200	60,900	64,600	87,000	95,900	118,100	123,100
~300		34,900	39,000	64,800	68,500	93,400	37,900	42,000	67,800	71,500	96,400	105,700	131,200	136,500

※ドラム式: 仕上り巾39cm以下の場合、仕上り丈は200cmまでとなります。

		コード式
H	W	18~30
50~100		23,100
~140		27,300
~180		28,300
~220		32,400
~240		36,100

		コード式				ドラム式								
H	W	30~45	~90	~140	~190	~240	30~45	~90	~140	~190	~240	~290	~340	~390
50~100		21,800	28,000	43,700	50,300	65,700	24,800	31,000	46,700	53,300	68,700	76,900	92,500	99,100
~140		25,800	32,500	51,700	58,700	77,800	28,800	35,500	54,700	61,700	80,800	89,300	108,300	115,200
~180		26,900	34,000	53,600	61,200	80,800	29,900	37,000	56,600	64,200	83,800	92,700	112,300	119,600
~220		30,900	38,500	61,600	69,600	92,800	33,900	41,500	64,600	72,600	95,800	105,100	127,200	134,900
~260		35,100	43,300	70,000	78,600	105,500	38,100	46,300	73,000	81,600	108,500	118,300	143,900	152,100
~300		39,300	48,000	78,400	87,600	117,700	42,300	51,000	81,400	90,600	120,700	130,900	160,700	169,300

※ドラム式: 仕上り巾39cm以下の場合、仕上り丈は200cmまでとなります。

		38mm (片開き/タッセルなし)					
H	W	~72	~100	~127	~155	~183	
~100		26,900	29,000	42,500	44,600	55,900	
~140		33,100	35,200	51,700	53,800	68,200	
~180		39,200	41,300	60,900	63,000	79,900	
~220		45,400	47,500	70,200	72,300	92,300	
~260		45,400	47,500	70,200	72,300	92,300	
~300		51,600	53,700	78,800	80,900	104,600	
26mm		-2,800	-2,100	-4,900	-4,200	-4,900	
18mm		-4,900	-5,600	-9,100	-9,800	-10,500	

※生地を伸ばした状態のサイズでご発注ください。

		スプリング・チェーンタイプ	
H	W	30~60	~90
50~80		33,900	36,400
~120		37,700	40,800
~160		38,800	42,600
~200		43,600	48,800
~240			50,900

※丈は巾の3倍までが限度です。
※ロールソフト加工品は非防災品になります。

		ストレートバランス				
H	W	~100	~150	~200	~250	~300
~40		19,600	24,000	33,700	38,100	47,900

※マジックテープ仕様・裏面スポンジ付の価格になります。

H	W	~100	~150	~200	~250	~300
~40		20,200	27,100	33,900	47,200	54,000

※マジックテープ仕様の価格になります。

モダン

TM-54014・54015



巾 ◇ 97cm 価格 ◇ 6,800円/m リポート ◇ タテ41.0cm ヨコ32.5cm 取扱表示 ◇ リ-30 40 防炎性能 ◇ (イ) 炎に布使用
 組成 ◇ ポリエステル100% 寸法変化率 ◇ 水洗い/タテ -0.2% ヨコ -0.5% ドライ/タテ -0.5% ヨコ -0.5% Made in Japan

モダン

H	W	~41 1巾(片開き)	~97 2巾	~145 3巾	~194 4巾	~242 5巾	~291 6巾	~339 7巾	~388 8巾
~100	15,800	30,900	44,800	57,800	70,900	84,700	97,800	111,600	111,600
~120	15,800	30,900	44,800	57,800	70,900	84,700	97,800	111,600	111,600
~140	19,100	37,400	54,500	70,900	88,000	104,300	121,500	137,700	137,700
~160	19,100	37,400	54,500	70,900	88,000	104,300	121,500	137,700	137,700
~180	22,400	44,800	64,400	84,700	104,300	124,800	145,100	164,700	164,700
~200	22,400	44,800	64,400	84,700	104,300	124,800	145,100	164,700	164,700
~220	25,600	51,200	74,900	97,800	121,500	145,100	167,900	191,600	191,600
~240	25,600	51,200	74,900	97,800	121,500	145,100	167,900	191,600	191,600
~260	28,900	57,800	84,700	111,600	137,700	164,700	191,600	218,500	218,500
~280	28,900	57,800	84,700	111,600	137,700	164,700	191,600	218,500	218,500
約1.5倍ヒダ	~53	~117	~194	~258	~323	~388	~452	~517	~517

※片開きはW270cmまで

H	W	~41 1巾(片開き)	~97 2巾	~145 3巾	~194 4巾	~242 5巾	~291 6巾	~339 7巾	~388 8巾
~100	16,100	31,500	45,800	59,100	72,500	86,600	100,100	114,200	114,200
~120	16,100	31,500	45,800	59,100	72,500	86,600	100,100	114,200	114,200
~140	19,500	38,200	55,700	72,500	90,000	106,600	124,300	140,900	140,900
~160	19,500	38,200	55,700	72,500	90,000	106,600	124,300	140,900	140,900
~180	22,800	45,800	65,800	86,600	106,600	127,600	148,500	168,500	168,500
~200	22,800	45,800	65,800	86,600	106,600	127,600	148,500	168,500	168,500
~220	26,200	52,400	76,600	100,100	124,300	148,500	171,800	196,000	196,000
~240	26,200	52,400	76,600	100,100	124,300	148,500	171,800	196,000	196,000
~260	29,600	59,100	86,600	114,200	140,900	168,500	196,000	223,600	223,600
~280	29,600	59,100	86,600	114,200	140,900	168,500	196,000	223,600	223,600
約1.5倍ヒダ	~53	~117	~194	~258	~323	~388	~452	~517	~517

※片開きはW270cmまで

H	W	~41 1巾(片開き)	~97 2巾	~145 3巾	~194 4巾	~242 5巾	~291 6巾	~339 7巾	~388 8巾
~100	15,500	30,200	43,800	56,500	69,300	82,800	95,600	109,100	109,100
~120	15,500	30,200	43,800	56,500	69,300	82,800	95,600	109,100	109,100
~140	18,700	36,600	53,300	69,300	86,000	101,900	118,700	134,600	134,600
~160	18,700	36,600	53,300	69,300	86,000	101,900	118,700	134,600	134,600
~180	21,900	43,800	62,900	82,800	101,900	121,900	141,800	160,800	160,800
~200	21,900	43,800	62,900	82,800	101,900	121,900	141,800	160,800	160,800
~220	25,100	50,100	73,200	95,600	118,700	141,800	164,000	187,100	187,100
~240	25,100	50,100	73,200	95,600	118,700	141,800	164,000	187,100	187,100
~260	28,300	56,500	82,800	109,100	134,600	160,800	187,100	213,400	213,400
~280	28,300	56,500	82,800	109,100	134,600	160,800	187,100	213,400	213,400
約1.5倍ヒダ	~53	~117	~194	~258	~323	~388	~452	~517	~517
フラット約1倍ヒダ	~77	~154	~251	~348	~445	~542			

H	W	~41 1巾(片開き)	~97 2巾	~145 3巾	~194 4巾	~242 5巾	~291 6巾	~339 7巾	~388 8巾
~100	16,800	32,800	47,800	61,600	75,700	90,500	104,600	119,300	119,300
~120	16,800	32,800	47,800	61,600	75,700	90,500	104,600	119,300	119,300
~140	20,300	39,800	58,100	75,700	94,000	111,400	129,900	147,300	147,300
~160	20,300	39,800	58,100	75,700	94,000	111,400	129,900	147,300	147,300
~180	23,800	47,800	68,700	90,500	111,400	133,400	155,200	176,100	176,100
~200	23,800	47,800	68,700	90,500	111,400	133,400	155,200	176,100	176,100
~220	27,300	54,600	79,900	104,600	129,900	155,200	179,600	205,000	205,000
~240	27,300	54,600	79,900	104,600	129,900	155,200	179,600	205,000	205,000
~260	30,800	61,600	90,500	119,300	147,300	176,100	205,000	233,800	233,800

※片開きはW300cmまで

H	W	コード式					ドラム式							
		30~45	~90	~140	~190	~240	30~45	~90	~140	~190	~240	~290	~340	~390
50~100	17,800	28,800	33,400	44,000	48,700	20,800	31,800	36,400	47,000	51,700	66,900	71,700	83,500	
~140	21,100	34,400	39,200	52,700	57,600	24,100	37,400	42,200	55,700	60,600	78,000	82,900	97,100	
~180	24,300	40,000	45,000	60,800	65,900	27,300	43,000	48,000	63,800	68,900	88,800	93,800	111,100	
~220	27,600	46,200	51,400	68,900	74,200	30,600	49,200	54,400	71,900	77,200	100,400	105,500	124,700	
~260	30,800	51,800	57,300	77,500	83,100	33,800	54,800	60,300	80,500	86,100	111,300	116,700	138,700	
~300	34,000	57,500	63,100	85,600	91,400	37,000	60,500	66,100	88,600	94,400	122,900	128,300	152,300	

※ドラム式:仕上り巾39cm以下の場合、仕上り丈は200cmまでとなります。

H	W	コード式					ドラム式							
		30~45	~90	~140	~190	~240	30~45	~90	~140	~190	~240	~290	~340	~390
50~100	20,700	34,300	40,900	54,900	61,200	23,700	37,300	43,900	57,900	64,200	80,400	86,900	100,900	
~140	24,200	40,700	47,800	65,200	72,200	27,200	43,700	50,800	68,200	75,200	93,500	100,500	117,100	
~180	27,700	47,000	54,600	75,000	82,500	30,700	50,000	57,600	78,000	85,500	106,700	114,200	134,400	
~220	31,200	54,000	62,000	84,700	92,900	34,200	57,000	65,000	87,700	95,900	120,500	128,100	150,400	
~260	34,800	60,700	69,300	95,700	104,500	37,800	63,700	72,300	98,700	107,500	134,400	142,600	168,500	
~300	38,400	67,300	76,600	106,000	115,500	41,400	70,300	79,600	109,000	118,500	149,000	157,600	185,900	

※ドラム式:仕上り巾39cm以下の場合、仕上り丈は200cmまでとなります。

H	W	~41 1巾(片開き)	~97 2巾	~145 3巾	~194 4巾	~242 5巾	~291 6巾	~339 7巾	~388 8巾
~100	21,900	43,100	57,000	76,100	95,300	109,100	128,300	148,200	148,200
~120	22,800	44,900	58,800	78,700	98,800	112,600	132,600	153,400	153,400
~140	27,000	53,100	70,200	94,400	119,400	135,700	160,700	184,700	184,700
~160	27,800	54,800	71,900	97,000	122,800	139,100	165,000	189,900	189,900
~180	32,000	64,000	83,600	113,500	142,600	163,100	193,000	222,200	222,200
~200	32,900	65,700	85,300	116,100	146,100	166,600	197,300	227,400	227,400
~220	37,000	73,900	97,600	131,800	166,800	190,400	224,500	259,500	259,500
~240	37,800	75,600	99,300	134,400	170,300	193,900	228,800	264,700	264,700
~260	42,000	83,900	110,800	150,800	189,900	216,900	256,900	296,800	296,800
~280	42,900	85,700	112,600	153,400	193,400	220,400	261,200	302,100	302,100
約1.5倍ヒダ	~53	~117	~194	~258	~323	~388	~452	~517	~517

※片開きはW270cmまで

H	W	~41 1巾(片開き)	~97 2巾	~145 3巾	~194 4巾	~242 5巾	~291 6巾	~339 7巾	~388 8巾
~100	22,700	44,600	58,900	78,700	98,600	112,700	132,700	153,300	153,300
~120	23,600	46,400	60,700	81,500	102,300	116,400	137,300	158,900	158,900
~140	27,900	55,000	72,500	97,700	123,500	140,100	166,200	191,200	191,200
~160	28,800	56,800	74,300	100,400	127,200	143,800	170,800	196,700	196,700
~180	33,100	66,300	86,300	117,300	147,600	168,600	199,700	229,900	229,900
~200	34,000	68,200	88,200	120,100	151,300	172,300	204,300	235,500	235,500
~220	38,300	76,600	100,800	136,400	172,700	196,900	232,300	268,600	268,600
~240	39,300	78,500	102,700	139,200	176,400	200,600	236,900	274,200	274,200
~260	43,600	87,000	114,500	156,100	196,700	224,300	265,800	307,300	307,300
~280	44,500	88,900	116,400	158,900	200,500	228,100	270,400	312,900	312,900
約1.5倍ヒダ	~53	~117	~194	~258	~323	~388	~452	~517	~517

※片開きはW270cmまで

H	W	~41 1巾(片開き)	~97 2巾	~145 3巾	~194 4巾	~242 5巾	~291 6巾	~339 7巾	~388 8巾
~100	21,200	41,600	55,200	73,600	92,000	105,500	124,000	143,200	143,200
~120	22,000	43,200	56,800	76					

TM-54016・54017



巾 ◇ 140cm 価格 ◇ 8,700円/m
組成 ◇ ポリエステル100%

リポート ◇ タテ 40.3cm ヨコ 70.0cm
寸法変化率 ◇ 水洗い/タテ 0.0% ヨコ 0.0%
ドライ/タテ 0.0% ヨコ 0.0%

取扱い表示 ◇ リ-30
防炎性能 ◇ (イ) あて布使用
Made in Japan

H	W	~62 1巾(片開き)	~140 2巾	~210 3巾	~280 4巾	~350 5巾	~420 6巾	~490 7巾
~100	20,500	39,900	57,000	74,000	91,000	108,200	125,200	
~120	20,500	39,900	57,000	74,000	91,000	108,200	125,200	
~140	24,700	48,400	69,700	91,000	112,300	133,700	155,000	
~160	24,700	48,400	69,700	91,000	112,300	133,700	155,000	
~180	29,000	57,000	82,500	108,200	133,700	159,300	185,900	
~200	29,000	57,000	82,500	108,200	133,700	159,300	185,900	
~220	33,400	65,500	95,300	125,200	155,000	185,900	215,800	
~240	33,400	65,500	95,300	125,200	155,000	185,900	215,800	
~260	37,500	74,000	108,200	142,300	177,400	211,600	245,600	
~280	37,500	74,000	108,200	142,300	177,400	211,600	245,600	
約1.5倍ヒダ	~78	~184	~280	~373	~466			

※片開きはW270cmまで

H	W	~62 1巾(片開き)	~140 2巾	~210 3巾	~280 4巾	~350 5巾	~420 6巾	~490 7巾
~100	21,000	40,800	58,400	75,800	93,300	110,900	128,300	
~120	21,000	40,800	58,400	75,800	93,300	110,900	128,300	
~140	25,300	49,500	71,400	93,300	115,200	137,000	158,900	
~160	25,300	49,500	71,400	93,300	115,200	137,000	158,900	
~180	29,700	58,400	84,600	110,900	137,000	163,400	190,700	
~200	29,700	58,400	84,600	110,900	137,000	163,400	190,700	
~220	34,200	67,100	97,700	128,300	158,900	190,700	221,300	
~240	34,200	67,100	97,700	128,300	158,900	190,700	221,300	
~260	38,500	75,800	110,900	145,900	182,000	217,000	251,900	
~280	38,500	75,800	110,900	145,900	182,000	217,000	251,900	
約1.5倍ヒダ	~78	~184	~280	~373	~466			

※片開きはW270cmまで

H	W	~62 1巾(片開き)	~140 2巾	~210 3巾	~280 4巾	~350 5巾	~420 6巾	~490 7巾	~560 8巾
~100	20,100	39,000	55,600	72,200	88,800	105,400	122,000	138,700	
~120	20,100	39,000	55,600	72,200	88,800	105,400	122,000	138,700	
~140	24,100	47,200	68,000	88,800	109,500	130,300	151,000	172,900	
~160	24,100	47,200	68,000	88,800	109,500	130,300	151,000	172,900	
~180	28,300	55,600	80,500	105,400	130,300	155,200	181,200	206,100	
~200	28,300	55,600	80,500	105,400	130,300	155,200	181,200	206,100	
~220	32,500	63,900	93,000	122,000	151,000	181,200	210,200	239,300	
~240	32,500	63,900	93,000	122,000	151,000	181,200	210,200	239,300	
~260	36,600	72,200	105,400	138,700	172,900	206,100	239,300	272,500	
~280	36,600	72,200	105,400	138,700	172,900	206,100	239,300	272,500	
約1.5倍ヒダ	~78	~184	~280	~373	~466	~560	~653	~746	
フラット前ヒダ	~120	~240	~380	~520					

H	W	~62 1巾(片開き)	~140 2巾	~210 3巾	~280 4巾	~350 5巾	~420 6巾	~490 7巾	~560 8巾
~100	22,000	42,600	61,200	79,500	97,800	116,300	134,600	153,200	
~120	22,000	42,600	61,200	79,500	97,800	116,300	134,600	153,200	
~140	26,500	51,800	74,800	97,800	120,800	143,800	166,800	191,100	
~160	26,500	51,800	74,800	97,800	120,800	143,800	166,800	191,100	
~180	31,100	61,200	88,600	116,300	143,800	171,500	200,200	227,900	
~200	31,100	61,200	88,600	116,300	143,800	171,500	200,200	227,900	
~220	35,800	70,300	102,500	134,600	166,800	200,200	232,400	264,500	
~240	35,800	70,300	102,500	134,600	166,800	200,200	232,400	264,500	
~260	40,300	79,500	116,300	153,200	191,100	227,900	264,500	301,400	

※片開きはW300cmまで

		コード式				ドラム式								
H	W	30~45	~90	~140	~190	~240	30~45	~90	~140	~190	~240	~290	~340	~390
50~100	19,200	23,200	37,400	41,200	45,900	22,200	26,200	40,400	44,200	48,900	65,300	70,100	74,900	
~140	23,900	27,900	44,600	48,300	53,200	26,900	30,900	47,600	51,300	56,200	76,000	80,900	85,800	
~180	27,800	31,700	51,700	55,300	60,500	30,800	34,700	54,700	58,300	63,500	86,500	91,500	96,500	
~220	31,800	35,700	58,900	62,400	67,800	34,800	38,700	61,900	65,400	70,800	97,200	102,300	107,400	
~260	35,600	39,600	66,000	69,500	75,000	38,600	42,600	69,000	72,500	78,000	107,600	113,100	118,100	
~300	39,500	43,600	73,100	76,600	82,400	42,500	46,600	76,100	79,600	85,400	118,300	123,700	129,000	

※ドラム式：仕上り巾39cm以下の場合、仕上り丈は200cmまでとなります。

		コード式				ドラム式								
H	W	30~45	~90	~140	~190	~240	30~45	~90	~140	~190	~240	~290	~340	~390
50~100	22,100	28,400	45,200	51,800	58,200	25,100	31,400	48,200	54,800	61,200	78,700	85,300	91,900	
~140	27,100	33,800	53,400	60,500	67,400	30,100	36,800	56,400	63,500	70,400	91,500	98,400	105,300	
~180	31,200	38,400	61,600	69,200	76,700	34,200	41,400	64,600	72,200	79,700	104,300	111,800	119,100	
~220	35,400	43,000	69,800	77,800	86,000	38,400	46,000	72,800	80,800	89,000	117,000	124,700	132,300	
~260	39,700	47,900	78,400	87,100	95,900	42,700	50,900	81,400	90,100	98,900	130,600	138,700	146,900	
~300	44,100	52,700	87,100	96,300	105,800	47,100	55,700	90,100	99,300	108,800	144,200	152,800	161,500	

※ドラム式：仕上り巾39cm以下の場合、仕上り丈は200cmまでとなります。

H	W	~62 1巾(片開き)	~140 2巾	~210 3巾	~280 4巾	~350 5巾	~420 6巾	~490 7巾
~100	26,600	52,100	75,300	98,400	121,500	144,800	167,900	
~120	27,500	53,900	77,900	101,900	125,800	150,000	174,000	
~140	32,600	64,100	93,200	122,400	151,500	180,700	209,900	
~160	33,400	65,800	95,800	125,800	155,800	185,900	215,900	
~180	38,600	76,200	111,300	146,500	181,600	216,800	252,900	
~200	39,500	77,900	113,900	150,000	185,900	222,000	259,000	
~220	44,800	88,200	129,300	170,500	211,600	253,800	295,000	
~240	45,600	89,900	131,900	174,000	215,900	259,000	301,100	
~260	50,600	100,100	147,400	194,500	242,700	289,900	337,000	
~280	51,500	101,900	150,000	198,000	247,000	295,200	343,100	
約1.5倍ヒダ	~78	~184	~280	~373	~466			

※片開きはW270cmまで

H	W	~62 1巾(片開き)	~140 2巾	~210 3巾	~280 4巾	~350 5巾	~420 6巾	~490 7巾
~100	27,600	53,900	78,000	101,900	125,900	150,000	173,900	
~120	28,500	55,700	80,800	105,600	130,500	155,600	180,400	
~140	33,700	66,300	96,600	126,800	157,100	187,300	217,500	
~160	34,600	68,100	99,300	130,500	161,700	192,800	224,000	
~180	40,000	78,900	115,300	151,900	188,200	224,800	262,400	
~200	40,900	80,800	118,100	155,600	192,800	230,400	268,900	
~220	46,300	91,300	134,000	176,700	219,400	263,300	306,000	
~240	47,300	93,200	136,800	180,400	224,000	268,900	312,500	
~260	52,500	103,700	152,800	201,700	251,800	300,700	349,600	
~280	53,400	105,600	155,600	205,500	256,400	306,300	356,100	
約1.5倍ヒダ	~78	~184	~280	~373	~466			

※片開きはW270cmまで

H	W	~62 1巾(片開き)	~140 2巾	~210 3巾	~280 4巾	~350 5巾	~420 6巾	~490 7巾	~560 8巾
~100	25,800	50,400	72,700	94,900	117,200	139,500	161,700	184,100	
~120	26,600	52,000	75,100	98,200	121,200	144,300	167,400	190,600	
~140	31,400	61,800	89,900	118,000	146,000	174,100	202,100	231,300	
~160	32,200	63,400	92,300	121,200	150,000	178,900	207,700	237,700	
~180	37,300	73,500	107,300	141,100	174,900	208,700	243,600	277,400	
~200	38,100	75,100	109,700	144,300	178,900	213,600	249,300	283,900	
~220	43,100	85,000	124,600	164,200	203,700	244,400	284,000	323,600	
~240	43,900	86,600	127,100	167,400	207,700	249,300	289,600	330,100	
~260	48,800	96,500	141,900	187,300	233,700	279,000	324,400	369,700	
~280	49,600	98,200	144,300	190,600	237,700	283,900	330,100	376,200	
約1.5倍ヒダ	~78	~184	~280	~373	~466	~560	~653		

TM-54018・54019

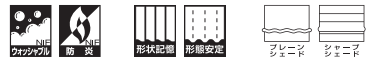

巾 ◇ 141 cm 価格 ◇ 9,100 円/㎡

リポート ◇ タテ 50.5 cm ヨコ 17.7 cm
寸法変化率 ◇ 水洗い/タテ -0.5% ヨコ -0.3%
ドライ/タテ -0.7% ヨコ -0.3%

取扱い表示 ◇ リ-30
防炎性能 ◇ (イ)
Made in Japan

標準仕様 形態安定加工価格表 約2倍ヒダ (タッセル含む)

H	W	~62 1巾(片開き)	~141 2巾	~211 3巾	~282 4巾	~352 5巾	~423 6巾	~493 7巾
~100		20,200	39,300	55,800	72,400	89,000	105,600	122,200
~120		25,800	50,300	72,400	94,600	116,700	140,000	162,100
~140		25,800	50,300	72,400	94,600	116,700	140,000	162,100
~160		25,800	50,300	72,400	94,600	116,700	140,000	162,100
~180		31,300	61,400	89,000	116,700	145,500	173,200	201,000
~200		31,300	61,400	89,000	116,700	145,500	173,200	201,000
~220		36,800	72,400	105,600	140,000	173,200	206,500	240,700
~240		36,800	72,400	105,600	140,000	173,200	206,500	240,700
~260		36,800	72,400	105,600	140,000	173,200	206,500	240,700
~280		42,400	83,500	122,200	162,100	201,000	240,700	279,600
約1.5倍ヒダ		~78	~184	~282	~376	~470		

※片開きはW270cmまで

プライム縫製仕様価格表 約2倍ヒダ (タッセル含む)

H	W	~62 1巾(片開き)	~141 2巾	~211 3巾	~282 4巾	~352 5巾	~423 6巾	~493 7巾
~100		20,700	40,100	57,100	74,200	91,200	108,200	125,200
~120		26,400	51,500	74,200	96,800	119,500	143,400	166,100
~140		26,400	51,500	74,200	96,800	119,500	143,400	166,100
~160		26,400	51,500	74,200	96,800	119,500	143,400	166,100
~180		32,000	62,800	91,200	119,500	149,100	177,400	206,000
~200		32,000	62,800	91,200	119,500	149,100	177,400	206,000
~220		37,700	74,200	108,200	143,400	177,400	211,600	246,700
~240		37,700	74,200	108,200	143,400	177,400	211,600	246,700
~260		37,700	74,200	108,200	143,400	177,400	211,600	246,700
~280		43,400	85,500	125,200	166,100	206,000	246,700	286,600
約1.5倍ヒダ		~78	~184	~282	~376	~470		

※片開きはW270cmまで

レギュラー縫製仕様価格表 約2倍ヒダ (タッセル含む)

H	W	~62 1巾(片開き)	~141 2巾	~211 3巾	~282 4巾	~352 5巾	~423 6巾	~493 7巾	~564 8巾
~100		19,800	38,400	54,500	70,700	86,900	103,100	119,200	136,500
~120		25,200	49,200	70,700	92,300	113,800	136,500	158,100	179,700
~140		25,200	49,200	70,700	92,300	113,800	136,500	158,100	179,700
~160		25,200	49,200	70,700	92,300	113,800	136,500	158,100	179,700
~180		30,600	59,900	86,900	113,800	141,900	168,900	196,000	222,900
~200		30,600	59,900	86,900	113,800	141,900	168,900	196,000	222,900
~220		36,000	70,700	103,100	136,500	168,900	201,300	234,700	267,200
~240		36,000	70,700	103,100	136,500	168,900	201,300	234,700	267,200
~260		36,000	70,700	103,100	136,500	168,900	201,300	234,700	267,200
~280		41,300	81,500	119,200	158,100	196,000	234,700	272,600	310,300
約1.5倍ヒダ		~78	~184	~282	~376	~470	~564	~658	~752
フラット約1倍ヒダ		~121	~242	~383	~524				

形状記憶加工価格表 約2倍ヒダ (タッセル含む)

H	W	~62 1巾(片開き)	~141 2巾	~211 3巾	~282 4巾	~352 5巾	~423 6巾	~493 7巾	~564 8巾
~100		21,600	41,900	59,700	77,600	95,400	113,300	131,100	150,300
~120		27,600	53,800	77,600	101,400	125,200	150,300	174,100	197,900
~140		27,600	53,800	77,600	101,400	125,200	150,300	174,100	197,900
~160		27,600	53,800	77,600	101,400	125,200	150,300	174,100	197,900
~180		33,500	65,700	95,400	125,200	156,300	186,000	216,000	245,700
~200		33,500	65,700	95,400	125,200	156,300	186,000	216,000	245,700
~220		39,500	77,600	113,300	150,300	186,000	221,900	258,700	294,600
~240		39,500	77,600	113,300	150,300	186,000	221,900	258,700	294,600
~260		39,500	77,600	113,300	150,300	186,000	221,900	258,700	294,600

※片開きはW300cmまで

style no.60 プレーンシェード

H	W	コード式					ドラム式							
		30~45	~90	~140	~190	~240	30~45	~90	~140	~190	~240	~290	~340	~390
50~100		22,900	26,700	43,000	46,600	51,300	25,900	29,700	46,000	49,600	54,300	73,600	78,400	83,200
~140		27,700	31,600	52,000	55,500	60,400	30,700	34,600	55,000	58,500	63,400	87,100	92,000	96,900
~180		28,600	32,500	53,100	56,700	61,800	31,600	35,500	56,100	59,700	64,800	88,600	93,600	98,600
~220		33,400	37,300	62,100	65,600	70,900	36,400	40,300	65,100	68,600	73,900	102,000	107,100	112,300
~260		38,200	42,200	71,100	74,500	80,000	41,200	45,200	74,100	77,500	83,000	115,200	120,700	125,700
~300		43,100	47,100	80,100	83,400	89,100	46,100	50,100	83,100	86,400	92,100	128,700	134,000	139,400

※ドラム式:仕上り巾39cm以下の場合、仕上り丈は200cmまでとなります。

style no.63 シャープシェード

H	W	コード式					ドラム式							
		30~45	~90	~140	~190	~240	30~45	~90	~140	~190	~240	~290	~340	~390
50~100		25,800	32,100	51,000	57,600	64,000	28,800	35,100	54,000	60,600	67,000	87,400	94,000	100,600
~140		31,000	37,700	61,200	68,200	75,200	34,000	40,700	64,200	71,200	78,200	103,100	110,000	116,900
~180		32,000	39,100	63,100	70,600	78,200	35,000	42,100	66,100	73,600	81,200	106,500	114,000	121,300
~220		37,200	44,700	73,200	81,200	89,400	40,200	47,700	76,200	84,200	92,400	122,100	129,800	137,400
~260		42,400	50,500	83,800	92,400	101,200	45,400	53,500	86,800	95,400	104,200	138,600	146,700	154,900
~300		47,700	56,400	94,300	103,500	113,100	50,700	59,400	97,300	106,500	116,100	155,000	163,700	172,300

※ドラム式:仕上り巾39cm以下の場合、仕上り丈は200cmまでとなります。

形態安定加工 推奨裏地付価格表(推奨裏地 TM-54419~54423) 約2倍ヒダ (タッセル含む)

H	W	~62 1巾(片開き)	~141 2巾	~211 3巾	~282 4巾	~352 5巾	~423 6巾	~493 7巾
~100		26,300	51,500	74,100	96,800	119,500	142,200	164,900
~120		32,800	64,300	93,300	122,500	151,500	181,800	210,900
~140		33,700	66,000	95,900	126,000	155,900	187,000	217,000
~160		34,500	67,700	98,500	129,400	160,200	192,200	223,000
~180		40,900	80,600	117,800	155,000	193,400	230,700	268,000
~200		41,800	82,300	120,400	158,500	197,700	235,900	274,100
~220		48,200	95,100	139,600	185,300	229,800	274,400	319,900
~240		49,000	96,800	142,200	188,800	234,100	279,600	326,000
~260		49,900	98,500	144,800	192,200	238,500	284,800	332,100
~280		56,400	111,400	164,000	217,800	270,600	324,300	377,100
約1.5倍ヒダ		~78	~184	~282	~376	~470		

※片開きはW270cmまで

プライム縫製仕様 推奨裏地付価格表(推奨裏地 TM-54419~54423) 約2倍ヒダ (タッセル含む)

H	W	~62 1巾(片開き)	~141 2巾	~211 3巾	~282 4巾	~352 5巾	~423 6巾	~493 7巾
~100		27,300	53,200	76,700	100,300	123,800	147,300	170,800
~120		33,900	66,400	96,600	126,600	156,700	188,100	218,200
~140		34,800	68,300	99,400	130,300	161,400	193,700	224,700
~160		35,700	70,100	102,100	134,000	166,000	199,200	231,200
~180		42,300	83,300	121,900	160,500	200,300	238,800	277,700
~200		43,200	85,200	124,700	164,200	204,900	244,400	284,200
~220		49,800	98,400	144,500	191,800	237,900	284,200	331,400
~240		50,800	100,300	147,300	195,500	242,500	289,800	337,900
~260		51,700	102,100	150,100	199,200	247,200	295,300	344,400
~280		58,300	115,300	169,900	225,700	280,400	336,000	390,800
約1.5倍ヒダ		~78	~184	~282	~376	~470		

※片開きはW270cmまで

レギュラー縫製仕様 推奨裏地付価格表(推奨裏地 TM-54419~54423) 約2倍ヒダ (タッセル含む)

H	W	~62 1巾(片開き)	~141 2巾	~211 3巾	~282 4巾	~352 5巾	~423 6巾	~493 7巾	~564 8巾
~100		25,500	49,800	71,600	93,400	115,300	137,200	158,900	181,900
~120		31,700	62,200	90,200	118,300	146,200	175,400	203,500	231,600
~140		32,500	63,800	92,600	121,500	150,300	180,300	209,200	238,100
~160		33,300	65,400	95,000	124,700	154,300	185,100	214,800	244,500
~180		39,600	77,800	113,700	149,500	186,500	222,400	258,400	294,200
~200		40,400	79,400	116,100	152,700	190,500	227,300	264,100	300,700
~220		46,600	91,800	134,700	178,700	221,600	264,500	308,500	351,500
~240		47,400	93,400	137,200	181,900	225,600	269,400	314,100	358,000
~260		48,200	95,000	139,600	185,100	229,700	274,200	319,800	364,400
~280		54,300	107,500	158,100	210,000	260,800	312,500	363,400	414,000
約1.5倍ヒダ		~78	~184	~282	~376	~470	~564	~658	~752

TM-54020・54021



巾 ◇ 100cm 価格 ◇ 6,700円/m リポート ◇ タテ 51.0cm ヨコ 33.0cm 取扱い表示 ◇ リ-30
 組成 ◇ ポリエステル100% 寸法変化率 ◇ 水洗い/タテ 0.0% ヨコ 0.0% 防炎性能 ◇ (イ)
 ドライ/タテ 0.0% ヨコ 0.0% Made in Japan

標準仕様 形態安定加工価格表 約2倍ヒダ (タッセル含む)

H	W	~44 1巾(片開き)	~100 2巾	~150 3巾	~200 4巾	~250 5巾	~300 6巾	~350 7巾	~400 8巾
~100		14,900	29,000	41,200	54,100	66,300	78,400	91,400	103,600
~120		19,000	37,100	54,100	70,300	86,500	103,600	119,800	136,800
~140		19,000	37,100	54,100	70,300	86,500	103,600	119,800	136,800
~160		19,000	37,100	54,100	70,300	86,500	103,600	119,800	136,800
~180		23,000	45,200	66,300	86,500	107,600	127,900	148,900	169,200
~200		23,000	45,200	66,300	86,500	107,600	127,900	148,900	169,200
~220		23,000	45,200	66,300	86,500	107,600	127,900	148,900	169,200
~240		27,100	54,100	78,400	103,600	127,900	153,000	178,100	202,400
~260		27,100	54,100	78,400	103,600	127,900	153,000	178,100	202,400
~280		31,100	62,200	91,400	119,800	148,900	178,100	206,400	235,600
約1.5倍ヒダ		~56	~120	~200	~266	~333	~400	~466	~533

※片開きはW270cmまで

プライム縫製仕様価格表 約2倍ヒダ (タッセル含む)

H	W	~44 1巾(片開き)	~100 2巾	~150 3巾	~200 4巾	~250 5巾	~300 6巾	~350 7巾	~400 8巾
~100		15,300	29,700	42,100	55,400	67,800	80,300	93,600	106,000
~120		19,400	38,000	55,400	72,000	88,600	106,000	122,600	140,000
~140		19,400	38,000	55,400	72,000	88,600	106,000	122,600	140,000
~160		19,400	38,000	55,400	72,000	88,600	106,000	122,600	140,000
~180		23,600	46,300	67,800	88,600	110,200	130,900	152,500	173,200
~200		23,600	46,300	67,800	88,600	110,200	130,900	152,500	173,200
~220		23,600	46,300	67,800	88,600	110,200	130,900	152,500	173,200
~240		27,700	55,400	80,300	106,000	130,900	156,600	182,400	207,300
~260		27,700	55,400	80,300	106,000	130,900	156,600	182,400	207,300
~280		31,900	63,700	93,600	122,600	152,500	182,400	211,400	241,300
約1.5倍ヒダ		~56	~120	~200	~266	~333	~400	~466	~533

※片開きはW270cmまで

レギュラー縫製仕様価格表 約2倍ヒダ (タッセル含む)

H	W	~44 1巾(片開き)	~100 2巾	~150 3巾	~200 4巾	~250 5巾	~300 6巾	~350 7巾	~400 8巾
~100		14,600	28,400	40,300	52,900	64,800	76,600	89,200	101,100
~120		18,600	36,300	52,900	68,700	84,500	101,100	116,900	133,500
~140		18,600	36,300	52,900	68,700	84,500	101,100	116,900	133,500
~160		18,600	36,300	52,900	68,700	84,500	101,100	116,900	133,500
~180		22,500	44,200	64,800	84,500	105,000	124,800	145,300	165,100
~200		22,500	44,200	64,800	84,500	105,000	124,800	145,300	165,100
~220		22,500	44,200	64,800	84,500	105,000	124,800	145,300	165,100
~240		26,500	52,900	76,600	101,100	124,800	149,300	173,800	197,500
~260		26,500	52,900	76,600	101,100	124,800	149,300	173,800	197,500
~280		30,400	60,800	89,200	116,900	145,300	173,800	201,400	229,900
約1.5倍ヒダ		~56	~120	~200	~266	~333	~400	~466	~533
フラット前ヒダ		~80	~160	~260	~360	~460	~560		

形状記憶加工価格表 約2倍ヒダ (タッセル含む)

H	W	~44 1巾(片開き)	~100 2巾	~150 3巾	~200 4巾	~250 5巾	~300 6巾	~350 7巾	~400 8巾
~100		15,900	30,900	43,900	57,900	70,900	84,000	97,900	110,900
~120		20,300	39,600	57,900	75,300	92,700	110,900	128,300	146,600
~140		20,300	39,600	57,900	75,300	92,700	110,900	128,300	146,600
~160		20,300	39,600	57,900	75,300	92,700	110,900	128,300	146,600
~180		24,600	48,300	70,900	92,700	115,300	137,000	159,700	181,400
~200		24,600	48,300	70,900	92,700	115,300	137,000	159,700	181,400
~220		24,600	48,300	70,900	92,700	115,300	137,000	159,700	181,400
~240		29,000	57,900	84,000	110,900	137,000	164,000	191,000	217,100
~260		29,000	57,900	84,000	110,900	137,000	164,000	191,000	217,100

※片開きはW300cmまで

TM-54022・54023



巾 ◇ 148 cm 価格 ◇ 6,800円/m リポート ◇ タテ 38.3 cm ヨコ 49.5 cm 取扱い表示 ◇ リ-30 防炎性能 ◇ (イ) 炎あて布使用
 組成 ◇ ポリエステル100% 寸法変化率 ◇ 水洗い/タテ 0.5% ヨコ 0.0% ドライ/タテ 0.0% ヨコ 0.0% Made in Japan

モダン

標準仕様 形態安定加工価格表 約2倍ヒダ (タッセル含む)

H	W	~65 1巾(片開き)	~148 2巾	~222 3巾	~296 4巾	~370 5巾	~444 6巾	~518 7巾
~100		16,200	31,500	44,800	59,000	72,300	85,600	99,800
~120		19,800	38,600	55,400	72,300	89,100	106,000	122,800
~140		19,800	38,600	55,400	72,300	89,100	106,000	122,800
~160		22,400	44,800	65,200	85,600	106,000	126,400	146,800
~180		22,400	44,800	65,200	85,600	106,000	126,400	146,800
~200		26,000	51,900	75,800	99,800	122,800	146,800	170,700
~220		26,000	51,900	75,800	99,800	122,800	146,800	170,700
~240		29,500	59,000	85,600	113,100	140,600	167,200	194,700
~260		29,500	59,000	85,600	113,100	140,600	167,200	194,700
~280		33,100	65,200	96,200	126,400	157,400	187,600	218,600
約1.5倍ヒダ		~86	~192	~296	~394	~493		

※片開きはW270cmまで

プライム縫製仕様価格表 約2倍ヒダ (タッセル含む)

H	W	~65 1巾(片開き)	~148 2巾	~222 3巾	~296 4巾	~370 5巾	~444 6巾	~518 7巾
~100		16,700	32,400	46,100	60,800	74,600	88,300	103,000
~120		20,400	39,800	57,200	74,600	92,000	109,400	126,800
~140		20,400	39,800	57,200	74,600	92,000	109,400	126,800
~160		23,100	46,100	67,200	88,300	109,400	130,400	151,500
~180		23,100	46,100	67,200	88,300	109,400	130,400	151,500
~200		26,800	53,500	78,200	103,000	126,800	151,500	176,300
~220		26,800	53,500	78,200	103,000	126,800	151,500	176,300
~240		30,400	60,800	88,300	116,700	145,200	172,600	201,000
~260		30,400	60,800	88,300	116,700	145,200	172,600	201,000
~280		34,100	67,200	99,300	130,400	162,600	193,700	225,800
約1.5倍ヒダ		~86	~192	~296	~394	~493		

※片開きはW270cmまで

レギュラー縫製仕様価格表 約2倍ヒダ (タッセル含む)

H	W	~65 1巾(片開き)	~148 2巾	~222 3巾	~296 4巾	~370 5巾	~444 6巾	~518 7巾	~592 8巾
~100		15,800	30,600	43,400	57,200	70,000	82,800	96,600	109,400
~120		19,200	37,400	53,700	70,000	86,300	102,600	118,800	136,000
~140		19,200	37,400	53,700	70,000	86,300	102,600	118,800	136,000
~160		21,700	43,400	63,100	82,800	102,600	122,300	142,000	161,700
~180		21,700	43,400	63,100	82,800	102,600	122,300	142,000	161,700
~200		25,200	50,300	73,400	96,600	118,800	142,000	165,200	188,300
~220		25,200	50,300	73,400	96,600	118,800	142,000	165,200	188,300
~240		28,600	57,200	82,800	109,400	136,000	161,700	188,300	214,900
~260		28,600	57,200	82,800	109,400	136,000	161,700	188,300	214,900
~280		32,000	63,100	93,200	122,300	152,300	181,400	211,500	240,600
約1.5倍ヒダ		~86	~192	~296	~394	~493	~592	~690	~789
フラット約1倍ヒダ		~128	~256	~404	~552				

形状記憶加工価格表 約2倍ヒダ (タッセル含む)

H	W	~65 1巾(片開き)	~148 2巾	~222 3巾	~296 4巾	~370 5巾	~444 6巾	~518 7巾	~592 8巾
~100		17,700	34,200	48,800	64,500	79,100	93,700	109,400	124,000
~120		21,600	42,100	60,600	79,100	97,600	116,200	134,700	154,300
~140		21,600	42,100	60,600	79,100	97,600	116,200	134,700	154,300
~160		24,400	48,800	71,300	93,700	116,200	138,600	161,000	183,500
~180		24,400	48,800	71,300	93,700	116,200	138,600	161,000	183,500
~200		28,400	56,700	83,000	109,400	134,700	161,000	187,400	213,800
~220		28,400	56,700	83,000	109,400	134,700	161,000	187,400	213,800
~240		32,300	64,500	93,700	124,000	154,300	183,500	213,800	244,000
~260		32,300	64,500	93,700	124,000	154,300	183,500	213,800	244,000

※片開きはW300cmまで

style no.60 プレーンシェード

H	W	コード式					ドラム式							
		30~45	~90	~140	~190	~240	30~45	~90	~140	~190	~240	~290	~340	~390
50~100		19,600	23,500	36,900	40,600	45,300	22,600	26,500	39,900	43,600	48,300	64,500	69,300	74,100
~140		22,900	26,800	42,700	46,400	51,400	25,900	29,800	45,700	49,400	54,400	73,300	78,200	83,100
~180		25,500	29,500	47,900	51,700	56,800	28,500	32,500	50,900	54,700	59,800	81,200	86,200	91,200
~220		28,800	32,800	53,800	57,500	62,800	31,800	35,800	56,800	60,500	65,800	89,900	95,000	100,100
~260		32,000	36,000	59,600	63,300	68,800	35,000	39,000	62,600	66,300	71,800	97,800	103,300	108,300
~300		35,200	39,300	64,800	68,500	74,300	38,200	42,300	67,800	71,500	77,300	106,600	111,900	117,300

※ドラム式:仕上り巾39cm以下の場合、仕上り巾は200cmまでとなります。

style no.63 シャープシェード

H	W	コード式					ドラム式							
		30~45	~90	~140	~190	~240	30~45	~90	~140	~190	~240	~290	~340	~390
50~100		22,500	28,800	44,600	51,200	57,600	25,500	31,800	47,600	54,200	60,600	77,900	84,500	91,100
~140		26,000	32,700	51,400	58,500	65,500	29,000	35,700	54,400	61,500	68,500	88,600	95,600	102,400
~180		28,900	36,000	57,600	65,200	72,700	31,900	39,000	60,600	68,200	75,700	98,700	106,300	113,600
~220		32,400	39,900	64,500	72,500	80,600	35,400	42,900	67,500	75,500	83,600	109,400	117,100	124,700
~260		36,000	44,100	71,700	80,400	89,200	39,000	47,100	74,700	83,400	92,200	120,300	128,500	136,600
~300		39,600	48,300	78,400	87,600	97,200	42,600	51,300	81,400	90,600	100,200	131,900	140,500	149,200

※ドラム式:仕上り巾39cm以下の場合、仕上り巾は200cmまでとなります。

形態安定加工 推奨裏地付価格表(推奨裏地 TM-54419~54423) 約2倍ヒダ (タッセル含む)

H	W	~65 1巾(片開き)	~148 2巾	~222 3巾	~296 4巾	~370 5巾	~444 6巾	~518 7巾
~100		22,300	43,700	63,100	83,400	102,800	122,200	142,500
~120		26,800	52,600	76,300	100,200	123,900	147,800	171,600
~140		27,700	54,300	78,900	103,700	128,300	153,000	177,700
~160		31,100	62,200	91,300	120,400	149,500	178,600	207,700
~180		32,000	64,000	94,000	123,900	153,900	183,900	213,800
~200		36,500	72,800	107,200	141,600	175,000	209,500	243,800
~220		37,400	74,600	109,800	145,100	179,400	214,700	249,900
~240		41,700	83,400	122,200	161,900	201,500	240,300	280,000
~260		42,600	85,100	124,800	165,300	205,900	245,500	286,100
~280		47,100	93,100	138,000	182,100	227,000	271,200	316,100
約1.5倍ヒダ		~86	~192	~296	~394	~493		

※片開きはW270cmまで

プライム縫製仕様 推奨裏地付価格表(推奨裏地 TM-54419~54423) 約2倍ヒダ (タッセル含む)

H	W	~65 1巾(片開き)	~148 2巾	~222 3巾	~296 4巾	~370 5巾	~444 6巾	~518 7巾
~100		23,300	45,500	65,700	86,900	107,200	127,400	148,600
~120		27,900	54,700	79,600	104,400	129,200	154,100	178,900
~140		28,800	56,600	82,400	108,100	133,900	159,700	185,400
~160		32,400	64,700	95,100	125,500	155,900	186,200	216,600
~180		33,400	66,600	97,900	129,300	160,600	191,800	223,200
~200		38,000	75,900	111,700	147,700	182,600	218,500	254,500
~220		38,900	77,700	114,500	151,400	187,300	224,100	261,000
~240		43,500	86,900	127,400	168,800	210,300	250,800	292,200
~260		44,400	88,700	130,200	172,500	215,000	256,300	298,700
~280		49,000	97,000	144,000	190,000	237,000	283,000	330,000
約1.5倍ヒダ		~86	~192	~296	~394	~493		

※片開きはW270cmまで

レギュラー縫製仕様 推奨裏地付価格表(推奨裏地 TM-54419~54423) 約2倍ヒダ (タッセル含む)

H	W	~65 1巾(片開き)	~148 2巾	~222 3巾	~296 4巾	~370 5巾	~444 6巾	~518 7巾	~592 8巾
~100		21,500	42,000	60,500	79,900	98,400	116,900	136,300	154,800
~120		25,700	50,400	73,200	96,000	118,700	141,500	164,200	187,900
~140		26,500	52,000	75,600	99,200	122,800	146,400	169,900	194,400
~160		29,800	59,600	87,400	115,200	143,100	170,900	198,700	226,500
~180		30,700	61,300	89,900	118,500	147,200	175,800	204,400	233,000
~200		35,000	69,800	102,600	135,500	167,400	200,400	233,300	266,100
~220		35,800	71,400	105,000	138,800	171,500	205,200	239,000	272,600
~240		40,000	79,900	116,900	154,800	192,700	229,800	267,700	305,700
~260		40,800	81,500						

TM-54024~54027



巾 ◇ 150cm 価格 ◇ 4,400円/m
組成 ◇ ポリエステル100%

リポート ◇ タテ 29.0cm ヨコ 15.5cm
寸法変化率 ◇ 水洗い/タテ -0.3% ヨコ 0.0%
ドライ/タテ -0.2% ヨコ 0.0%

取扱い表示 ◇ リ-30
防炎性能 ◇ (イ) あて布使用
Made in Japan

H	W	~67 1巾(片開き)	~150 2巾	~225 3巾	~300 4巾	~375 5巾	~450 6巾	~525 7巾
~100		11,300	21,900	31,600	40,700	50,500	59,600	69,300
~120		13,200	25,800	37,500	48,500	59,600	71,300	82,300
~140		15,200	29,700	42,700	56,300	69,300	82,300	96,000
~160		15,200	29,700	42,700	56,300	69,300	82,300	96,000
~180		17,100	33,600	48,500	63,500	78,400	94,000	109,000
~200		19,100	37,500	54,400	71,300	88,200	105,100	122,000
~220		19,100	37,500	54,400	71,300	88,200	105,100	122,000
~240		20,400	40,700	59,600	78,400	97,300	116,100	135,000
~260		22,300	44,600	65,400	86,200	107,000	127,800	148,600
~280		22,300	44,600	65,400	86,200	107,000	127,800	148,600
約1.5倍ヒダ		~88	~200	~300	~400	~500		

※片開きはW270cmまで

H	W	~67 1巾(片開き)	~150 2巾	~225 3巾	~300 4巾	~375 5巾	~450 6巾	~525 7巾
~100		11,800	22,800	32,900	42,400	52,700	62,200	72,400
~120		13,800	26,900	39,100	50,600	62,200	74,500	86,000
~140		15,900	31,000	44,600	58,800	72,400	86,000	100,300
~160		15,900	31,000	44,600	58,800	72,400	86,000	100,300
~180		17,800	35,000	50,600	66,300	81,900	98,200	113,900
~200		20,000	39,100	56,800	74,500	92,200	109,800	127,500
~220		20,000	39,100	56,800	74,500	92,200	109,800	127,500
~240		21,300	42,400	62,200	81,900	101,700	121,300	141,100
~260		23,300	46,500	68,300	90,000	111,800	133,600	155,300
~280		23,300	46,500	68,300	90,000	111,800	133,600	155,300
約1.5倍ヒダ		~88	~200	~300	~400	~500		

※片開きはW270cmまで

H	W	~67 1巾(片開き)	~150 2巾	~225 3巾	~300 4巾	~375 5巾	~450 6巾	~525 7巾	~600 8巾
~100		10,900	21,000	30,300	39,000	48,300	57,000	66,200	74,900
~120		12,700	24,800	35,900	46,400	57,000	68,200	78,600	89,800
~140		14,600	28,500	40,900	53,800	66,200	78,600	91,700	104,100
~160		14,600	28,500	40,900	53,800	66,200	78,600	91,700	104,100
~180		16,400	32,200	46,400	60,700	74,900	89,800	104,100	118,300
~200		18,300	35,900	52,000	68,200	84,300	100,400	116,500	132,600
~220		18,300	35,900	52,000	68,200	84,300	100,400	116,500	132,600
~240		19,600	39,000	57,000	74,900	93,000	110,900	128,900	146,800
~260		21,400	42,700	62,500	82,400	102,200	122,000	141,900	161,700
~280		21,400	42,700	62,500	82,400	102,200	122,000	141,900	161,700
約1.5倍ヒダ		~88	~200	~300	~400	~500	~600	~700	~800
フラット前ヒダ		~130	~260	~410	~560				

H	W	~67 1巾(片開き)	~150 2巾	~225 3巾	~300 4巾	~375 5巾	~450 6巾	~525 7巾	~600 8巾
~100		12,700	24,600	35,600	45,900	57,100	67,500	78,500	88,800
~120		14,800	29,000	42,300	54,800	67,500	80,800	93,300	106,600
~140		17,200	33,400	48,200	63,700	78,500	93,300	108,900	123,700
~160		17,200	33,400	48,200	63,700	78,500	93,300	108,900	123,700
~180		19,300	37,900	54,800	71,900	88,800	106,600	123,700	140,600
~200		21,600	42,300	61,600	80,800	100,000	119,300	138,500	157,800
~220		21,600	42,300	61,600	80,800	100,000	119,300	138,500	157,800
~240		23,100	45,900	67,500	88,800	110,400	131,800	153,300	174,700
~260		25,200	50,400	74,000	97,700	121,400	145,100	168,800	192,400

※片開きはW300cmまで

		コード式				ドラム式								
H	W	30~45	~90	~140	~190	~240	30~45	~90	~140	~190	~240	~290	~340	~390
50~100		15,900	19,900	24,400	33,600	38,300	18,900	22,900	27,400	36,600	41,300	48,600	59,100	63,900
~140		17,900	22,000	26,700	37,100	42,000	20,900	25,000	29,700	40,100	45,000	52,600	64,300	69,200
~180		19,900	24,000	29,000	40,500	45,700	22,900	27,000	32,000	43,500	48,700	56,400	68,900	74,000
~220		23,100	27,200	32,400	46,200	51,500	26,100	30,200	35,400	49,200	54,500	62,600	77,500	82,700
~260		24,600	28,900	34,300	49,300	54,800	27,600	31,900	37,300	52,300	57,800	66,000	82,400	87,400
~300		26,700	31,000	36,600	52,700	58,500	29,700	34,000	39,600	55,700	61,500	70,000	87,400	92,800

※ドラム式: 仕上り巾39cm以下の場合、仕上り丈は200cmまでとなります。

		コード式	
H	W	18~30	
50~100		18~30	20,300
~140			22,900
~180			24,900
~220			28,600
~240			29,600

		コード式				ドラム式								
H	W	30~45	~90	~140	~190	~240	30~45	~90	~140	~190	~240	~290	~340	~390
50~100		18,700	24,900	31,600	43,700	50,100	21,700	27,900	34,600	46,700	53,100	61,300	73,800	80,300
~140		20,900	27,600	34,700	48,500	55,500	23,900	30,600	37,700	51,500	58,500	67,000	81,100	87,900
~180		23,100	30,300	37,800	53,300	60,800	26,100	33,300	40,800	56,300	63,800	72,700	88,200	95,500
~220		26,600	34,100	42,100	60,400	68,600	29,600	37,100	45,100	63,400	71,600	80,900	98,800	106,500
~260		28,500	36,600	45,300	65,400	74,200	31,500	39,600	48,300	68,400	77,200	87,000	106,600	114,800
~300		30,900	39,600	48,800	70,700	80,300	33,900	42,600	51,800	73,700	83,300	93,600	114,900	123,500

※ドラム式: 仕上り巾39cm以下の場合、仕上り丈は200cmまでとなります。

		38mm (片開き/タッセルなし)					
H	W	~72	~100	~127	~155	~183	
~100		15,600	24,300	28,500	30,600	39,700	
~140		18,400	29,900	34,100	36,200	47,800	
~180		19,800	32,800	37,000	39,100	52,000	
~220		21,200	35,600	39,800	41,900	56,300	
~260		23,600	40,800	45,000	47,100	64,300	
~300		25,000	43,600	47,800	49,900	68,500	
26mm		-2,800	-2,100	-4,900	-4,200	-4,900	
18mm		-4,900	-5,600	-9,100	-9,800	-10,500	

※生地を伸ばした状態のサイズでご発注ください。

		スプリング・チェーンタイプ				
H	W	30~60	~80	~100	~120	~140
50~80		31,100	33,600	35,600	36,800	38,500
~120		33,300	36,400	38,400	39,500	41,400
~160		35,400	39,200	41,200	42,400	43,700
~200		39,800	42,800	45,000	46,200	47,500
~240			45,100	47,400	48,600	50,000

※丈は巾の3倍までが限度です。
※ロールソフト加工品は非防炎品になります。

		ストレートバランス				
H	W	~100	~150	~200	~250	~300
~40		11,000	17,500	21,900	26,300	32,800

※マジックテープ仕様・裏面スポンジ付の価格になります。

H	W	~100	~150	~200	~250	~300
~40		10,500	15,200	19,500	25,100	26,600

※マジックテープ仕様の価格になります。

モダン

TM-54032



巾 ◇ 300cm ヨコ使い 価格 ◇ 9,300円/m リポート ◇ タテ cm ヨコ cm 取扱い表示 ◇ リ-30 防炎性能 ◇ -
 組成 ◇ ポリエステル100% 寸法変化率 ◇ 水洗い/タテ -0.3% ヨコ 0.0% ドライ/タテ -0.3% ヨコ -0.5% Made in Turkey

ナチュラル

H \ W	~50 (片開き)	~100	~150	~200	~250	~300	~350	~400
~100	12,100	23,100	34,000	45,000	56,000	67,000	78,000	88,900
~120	12,400	23,700	34,900	46,100	57,300	68,500	79,800	91,000
~140	12,700	24,100	35,600	47,100	58,500	70,000	81,400	92,900
~160	12,900	24,600	36,300	48,000	59,700	71,400	83,100	94,800
~180	13,200	25,100	37,000	49,000	60,900	72,900	84,800	96,700
~200	13,400	25,600	37,800	49,900	62,100	74,300	86,500	98,700
~220	13,800	26,200	38,600	51,000	63,400	75,900	88,300	100,700
~240	14,000	26,700	39,300	52,000	64,600	77,300	90,000	102,600
~260	14,200	27,100	40,000	52,900	65,800	78,700	91,600	104,500
約1.5倍ヒダ	~60	~120	~200	~266	~333	~400	~466	~533
フラット前ヒダ	~90	~160	~260	~360	~460	~560		

H \ W	~50 (片開き)	~100	~150	~200	~250	~300	~350	~400
~100	12,700	24,200	35,800	47,300	58,800	70,400	81,900	93,500
~120	13,200	25,000	36,900	48,700	60,600	72,500	84,300	96,200
~140	13,500	25,700	37,800	50,000	62,200	74,400	86,600	98,700
~160	13,800	26,300	38,800	51,300	63,800	76,300	88,800	101,300
~180	14,100	26,900	39,800	52,600	65,400	78,200	91,000	103,900
~200	14,400	27,600	40,700	53,900	67,000	80,100	93,300	106,400
~220	14,900	28,400	41,800	55,300	68,800	82,200	95,700	109,100
~240	15,200	29,000	42,800	56,600	70,400	84,100	97,900	111,700
~260	15,600	29,700	43,800	57,900	72,000	86,100	100,200	114,300
~280	15,600	29,700	43,800	57,900	72,000	86,100	100,200	114,300
約1.5倍ヒダ	~60	~120	~200	~266	~333	~400	~466	~533
フラット前ヒダ	~90	~160	~260	~360	~460	~560		

H \ W	~50 (片開き)	~100	~150	~200	~250	~300	~350	~400
~100	12,400	23,600	34,900	46,200	57,400	68,700	79,900	91,200
~120	12,800	24,300	35,900	47,400	59,000	70,500	82,000	93,600
~140	13,100	24,900	36,700	48,500	60,400	72,200	84,000	95,800
~160	13,400	25,500	37,600	49,700	61,800	73,900	86,000	98,100
~180	13,600	26,000	38,400	50,800	63,200	75,500	87,900	100,300
~200	13,900	26,600	39,200	51,900	64,600	77,200	89,900	102,500
~220	14,300	27,300	40,200	53,200	66,100	79,000	92,000	104,900
~240	14,600	27,800	41,100	54,300	67,500	80,700	93,900	107,200
~260	14,900	28,400	41,900	55,400	68,900	82,400	95,900	109,400
約1.5倍ヒダ	~60	~120	~200	~266	~333	~400	~466	~533

H \ W	~50 (片開き)	~100	~150	~200	~250	~300	~350	~400
~100	13,000	24,800	36,600	48,400	60,300	72,100	83,900	95,700
~120	13,500	25,700	37,900	50,100	62,200	74,400	86,600	98,800
~140	13,900	26,400	39,000	51,500	64,000	76,600	89,100	101,700
~160	14,200	27,100	40,000	52,900	65,800	78,700	91,600	104,500
~180	14,600	27,900	41,100	54,400	67,600	80,900	94,200	107,400
~200	15,000	28,600	42,200	55,800	69,400	83,100	96,700	110,300
~220	15,500	29,500	43,500	57,400	71,400	85,400	99,400	113,400
~240	15,900	30,200	44,500	58,900	73,200	87,600	101,900	116,200
~260	16,200	30,900	45,600	60,300	75,000	89,700	104,400	119,100
~280	16,200	30,900	45,600	60,300	75,000	89,700	104,400	119,100
約1.5倍ヒダ	~60	~120	~200	~266	~333	~400	~466	~533

H \ W	~50 (片開き)	~100	~150	~200	~250	~300	~350	~400
~100	12,700	24,200	35,800	47,300	58,800	70,400	81,900	93,500
~120	13,200	25,000	36,900	48,700	60,600	72,500	84,300	96,200
~140	13,500	25,700	37,800	50,000	62,200	74,400	86,600	98,700
~160	13,800	26,300	38,800	51,300	63,800	76,300	88,800	101,300
~180	14,100	26,900	39,800	52,600	65,400	78,200	91,000	103,900
~200	14,400	27,600	40,700	53,900	67,000	80,100	93,300	106,400
~220	14,900	28,400	41,800	55,300	68,800	82,200	95,700	109,100
~240	15,200	29,000	42,800	56,600	70,400	84,100	97,900	111,700
~260	15,600	29,700	43,800	57,900	72,000	86,100	100,200	114,300
約1.5倍ヒダ	~60	~120	~200	~266	~333	~400	~466	~533

H \ W	~50 (片開き)	~100	~150	~200	~250	~300	~350	~400
~100	13,300	25,400	37,500	49,600	61,700	73,800	85,900	98,000
~120	13,900	26,400	38,900	51,400	63,900	76,400	88,900	101,400
~140	14,300	27,200	40,100	53,000	65,900	78,800	91,700	104,600
~160	14,700	28,000	41,300	54,600	67,900	81,200	94,500	107,800
~180	15,100	28,800	42,500	56,200	69,900	83,600	97,300	111,000
~200	15,500	29,600	43,700	57,800	71,900	86,000	100,100	114,200
~220	16,100	30,600	45,100	59,600	74,100	88,600	103,100	117,600
~240	16,500	31,400	46,300	61,200	76,100	91,000	105,900	120,800
~260	16,900	32,200	47,500	62,800	78,100	93,400	108,700	124,000
約1.5倍ヒダ	~60	~120	~200	~266	~333	~400	~466	~533

		コード式				ドラム式								
H \ W		30~45	~90	~140	~190	~240	30~45	~90	~140	~190	~240	~290	~340	~390
50~100		19,900	23,800	28,300	32,300	37,000	22,900	26,800	31,300	35,300	40,000	47,200	61,600	66,400
~140		24,000	27,900	32,700	36,600	41,600	27,000	30,900	35,700	39,600	44,600	52,200	69,900	74,800
~180		28,100	32,000	37,000	41,000	46,100	31,100	35,000	40,000	44,000	49,100	56,800	77,900	82,900
~220		32,300	36,200	41,400	45,400	50,700	35,300	39,200	44,400	48,400	53,700	61,700	86,000	91,200
~260		36,300	40,300	45,700	49,700	55,200	39,300	43,300	48,700	52,700	58,200	66,400	94,300	99,300
~280		40,500	44,500	50,100	54,100	59,900	43,500	47,500	53,100	57,100	62,900	71,300	102,300	107,600

		コード式
H \ W		18~30
50~100		24,000
~140		28,500
~180		32,400
~220		36,900
~240		39,400

		コード式					ドラム式							
H \ W		30~45	~90	~140	~190	~240	30~45	~90	~140	~190	~240	~290	~340	~390
50~100		22,800	29,000	35,700	42,300	48,600	25,800	32,000	38,700	45,300	51,600	59,800	76,400	83,000
~140		27,200	33,900	41,000	48,000	55,000	30,200	36,900	44,000	51,000	58,000	66,500	86,800	93,700
~180		31,500	38,700	46,200	53,800	61,300	34,500	41,700	49,200	56,800	64,300	73,200	97,500	104,800
~220		36,000	43,500	51,500	59,500	67,700	39,000	46,500	54,500	62,500	70,700	80,000	107,700	115,300
~260		40,400	48,600	57,200	65,900	74,700	43,400	51,600	60,200	68,900	77,700	87,500	119,100	127,200
~280		45,000	53,700	62,900	72,200	81,700	48,000	56,700	65,900	75,200	84,700	95,000	130,400	139,100

		コード式					ドラム式							
スワッグ数		1S	2S	3S	4S	5S	1S	2S	3S	4S	5S	6S	7S	8S
H \ W		36~50	~100	~150	~200	~250	40~50	~100	~150	~200	~250	~300	~350	~400
100~140		26,800	44,700	63,400	82,100	102,600	29,800	47,700	66,400	85,100	105,600	126,200	146,700	167,100
~180		28,800	47,500	67,100	86,700	108,400	31,800	50,500	70,100	89,700	111,400	133,000	154,600	176,300
~220		30,900	50,300	70,800	91,300	114,100	33,900	53,300	73,800	94,300	117,100	139,700	162,500	185,400
~260		32,100	53,100	74,500	95,900	120,000	35,100	56,100	77,500	98,900	123,000	146,500	170,500	190,500
~280		35,000	55,900	78,200	100,500	125,700	38,000	58,900	81,200	103,500	128,700	153,200	178,400	203,600

※ 出窓の場合はコーナー1ヶ所につきコード式は3,500円、ドラム式は4,500円プラスになります。

TM-54034



巾 ◇ 270 cm ヨコ使い 価格 ◇ 12,500 円/m リピート ◇ タテ - cm ヨコ 7.0 cm 取扱い表示 ◇ リ-30
 組成 ◇ ポリエステル100% 寸法変化率 ◇ 水洗い/タテ 0.0% ヨコ 0.0% 防炎性能 ◇ -
 ドライ/タテ -0.7% ヨコ 0.0% Made in Turkey あて布使用

標準仕様		レギュラー縫製仕様価格表 約2倍ヒダ (タッセルなし)							
	W	~50 (片開き)	~100	~150	~200	~250	~300	~350	~400
H									
~100		15,600	29,800	44,000	58,100	72,300	86,500	100,700	114,900
~120		16,000	30,400	44,800	59,200	73,600	88,100	102,500	116,900
~140		16,200	30,900	45,500	60,200	74,800	89,500	104,200	118,800
~160		16,400	31,300	46,200	61,100	76,000	90,900	105,800	120,700
~180		16,700	31,800	47,000	62,100	77,200	92,400	107,500	122,700
~200		16,900	32,300	47,700	63,100	78,400	93,800	109,200	124,600
~220		17,300	32,900	48,500	64,100	79,800	95,400	111,000	126,600
~230		17,400	33,100	48,900	64,600	80,400	96,100	111,800	127,600
約1.5倍ヒダ		~60	~120	~200	~266	~333	~400	~466	~533
フラット約1倍ヒダ		~90	~160	~260	~360	~460	~560		

ナチュ
ユラル

TM-54035

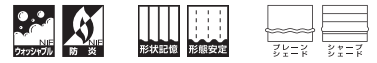

巾 ◇ 148cm 価格 ◇ 8,600円/m
組成 ◇ ポリエステル100%

リポート ◇ タテ 52.2cm ヨコ 37.0cm
寸法変化率 ◇ 水洗い/タテ 0.2% ヨコ 0.0%
ドライ/タテ -0.7% ヨコ -0.8%

取扱い表示 ◇ リ-30 30 40 50 60 70 80 90 100
防炎性能 ◇ (イ) あて布使用
Made in Japan

H	W	~65 1巾(片開き)	~148 2巾	~222 3巾	~296 4巾	~370 5巾	~444 6巾	~518 7巾
~100	19,500	38,800	54,900	71,900	89,000	105,000	122,100	122,100
~120	19,500	38,800	54,900	71,900	89,000	105,000	122,100	122,100
~140	24,800	49,500	71,900	94,300	116,700	139,100	161,600	161,600
~160	24,800	49,500	71,900	94,300	116,700	139,100	161,600	161,600
~180	31,200	61,200	89,000	116,700	144,500	172,200	200,000	200,000
~200	31,200	61,200	89,000	116,700	144,500	172,200	200,000	200,000
~220	31,200	61,200	89,000	116,700	144,500	172,200	200,000	200,000
~240	36,500	71,900	105,000	139,100	172,200	205,300	239,500	239,500
~260	36,500	71,900	105,000	139,100	172,200	205,300	239,500	239,500
~280	41,900	82,600	122,100	161,600	200,000	239,500	277,900	277,900
約1.5倍ヒダ	~86	~192	~296	~394	~493			

※片開きはW270cmまで

H	W	~65 1巾(片開き)	~148 2巾	~222 3巾	~296 4巾	~370 5巾	~444 6巾	~518 7巾
~100	20,000	39,700	56,300	73,700	91,300	107,800	125,400	125,400
~120	20,000	39,700	56,300	73,700	91,300	107,800	125,400	125,400
~140	25,400	50,700	73,700	96,800	119,800	142,800	166,000	166,000
~160	25,400	50,700	73,700	96,800	119,800	142,800	166,000	166,000
~180	32,000	62,700	91,300	119,800	148,400	176,800	205,400	205,400
~200	32,000	62,700	91,300	119,800	148,400	176,800	205,400	205,400
~220	32,000	62,700	91,300	119,800	148,400	176,800	205,400	205,400
~240	37,400	73,700	107,800	142,800	176,800	210,800	246,000	246,000
~260	37,400	73,700	107,800	142,800	176,800	210,800	246,000	246,000
~280	43,000	84,700	125,400	166,000	205,400	246,000	285,500	285,500
約1.5倍ヒダ	~86	~192	~296	~394	~493			

※片開きはW270cmまで

H	W	~65 1巾(片開き)	~148 2巾	~222 3巾	~296 4巾	~370 5巾	~444 6巾	~518 7巾	~592 8巾
~100	19,000	37,800	53,500	70,000	86,700	102,200	118,800	135,400	135,400
~120	19,000	37,800	53,500	70,000	86,700	102,200	118,800	135,400	135,400
~140	24,100	48,200	70,000	91,800	113,600	135,400	157,300	177,900	177,900
~160	24,100	48,200	70,000	91,800	113,600	135,400	157,300	177,900	177,900
~180	30,400	59,600	86,700	113,600	140,600	167,500	194,600	221,500	221,500
~200	30,400	59,600	86,700	113,600	140,600	167,500	194,600	221,500	221,500
~220	30,400	59,600	86,700	113,600	140,600	167,500	194,600	221,500	221,500
~240	35,500	70,000	102,200	135,400	167,500	199,700	233,000	265,100	265,100
~260	35,500	70,000	102,200	135,400	167,500	199,700	233,000	265,100	265,100
~280	40,800	80,400	118,800	157,300	194,600	233,000	270,300	308,700	308,700
約1.5倍ヒダ	~86	~192	~296	~394	~493	~592	~690	~789	~789
フラット前ヒダ	~128	~256	~404	~552					

H	W	~65 1巾(片開き)	~148 2巾	~222 3巾	~296 4巾	~370 5巾	~444 6巾	~518 7巾	~592 8巾
~100	20,900	41,600	59,100	77,500	96,000	113,300	131,900	150,200	150,200
~120	20,900	41,600	59,100	77,500	96,000	113,300	131,900	150,200	150,200
~140	26,600	53,200	77,500	101,700	126,000	150,200	174,700	197,700	197,700
~160	26,600	53,200	77,500	101,700	126,000	150,200	174,700	197,700	197,700
~180	33,600	65,900	96,000	126,000	156,100	186,100	216,300	246,200	246,200
~200	33,600	65,900	96,000	126,000	156,100	186,100	216,300	246,200	246,200
~220	33,600	65,900	96,000	126,000	156,100	186,100	216,300	246,200	246,200
~240	39,300	77,500	113,300	150,200	186,100	222,000	259,100	294,700	294,700
~260	39,300	77,500	113,300	150,200	186,100	222,000	259,100	294,700	294,700

※片開きはW300cmまで

		コード式				ドラム式								
H	W	30~45	~90	~140	~190	~240	30~45	~90	~140	~190	~240	~290	~340	~390
50~100	~100	22,200	26,000	42,400	46,000	50,700	25,200	29,000	45,400	49,000	53,700	72,400	77,200	82,000
	~140	23,000	27,000	43,600	47,300	52,200	26,000	30,000	46,600	50,300	55,200	74,100	79,000	83,900
	~180	27,600	31,600	52,100	55,700	60,800	30,600	34,600	55,100	58,700	63,800	87,400	92,500	97,500
	~220	33,100	37,000	61,400	64,900	70,200	36,100	40,000	64,400	67,900	73,200	101,000	106,100	111,200
	~260	37,600	41,600	69,900	73,400	78,900	40,600	44,600	72,900	76,400	81,900	113,500	119,000	124,000
	~300	42,300	46,200	78,500	81,800	87,600	45,300	49,200	81,500	84,800	90,600	127,100	132,400	137,800

※ドラム式：仕上り巾39cm以下の場合、仕上り丈は200cmまでとなります。

		コード式				ドラム式								
H	W	30~45	~90	~140	~190	~240	30~45	~90	~140	~190	~240	~290	~340	~390
50~100	~100	25,100	31,400	50,400	57,000	63,400	28,100	34,400	53,400	60,000	66,400	86,100	92,700	99,300
	~140	26,200	32,900	52,300	59,400	66,400	29,200	35,900	55,300	62,400	69,400	89,500	96,400	103,300
	~180	31,100	38,200	62,000	69,600	77,100	34,100	41,200	65,000	72,600	80,100	105,300	112,800	120,100
	~220	36,800	44,300	72,500	80,500	88,600	39,800	47,300	75,500	83,500	91,600	121,000	128,700	136,300
	~260	41,800	49,900	82,600	91,200	100,000	44,800	52,900	85,600	94,200	103,000	136,800	144,900	153,100
	~300	46,900	55,500	92,700	101,900	111,500	49,900	58,500	95,700	104,900	114,500	153,400	162,000	170,600

※ドラム式：仕上り巾39cm以下の場合、仕上り丈は200cmまでとなります。

H	W	~65 1巾(片開き)	~148 2巾	~222 3巾	~296 4巾	~370 5巾	~444 6巾	~518 7巾
~100	25,600	51,000	73,200	96,300	119,500	141,600	164,800	164,800
~120	26,500	52,800	75,800	99,800	123,800	146,800	170,900	170,900
~140	32,700	65,200	95,400	125,700	155,900	186,100	216,500	216,500
~160	33,500	66,900	98,000	129,100	160,200	191,300	222,500	222,500
~180	40,800	80,400	117,800	155,000	192,400	229,700	267,000	267,000
~200	41,700	82,100	120,400	158,500	196,700	234,900	273,100	273,100
~220	42,600	83,900	123,000	162,000	201,100	240,100	279,200	279,200
~240	48,700	96,300	141,600	187,900	233,100	278,400	324,800	324,800
~260	49,600	98,000	144,200	191,300	237,500	283,600	330,900	330,900
~280	55,900	110,500	163,900	217,300	269,600	323,100	375,400	375,400
約1.5倍ヒダ	~86	~192	~296	~394	~493			

※片開きはW270cmまで

H	W	~65 1巾(片開き)	~148 2巾	~222 3巾	~296 4巾	~370 5巾	~444 6巾	~518 7巾
~100	26,600	52,800	75,900	99,800	123,900	146,900	171,000	171,000
~120	27,500	54,600	78,700	103,500	128,500	152,500	177,500	177,500
~140	33,800	67,500	98,900	130,300	161,700	193,100	224,600	224,600
~160	34,700	69,300	101,600	134,000	166,300	198,600	231,100	231,100
~180	42,300	83,200	122,000	160,800	199,600	238,200	277,100	277,100
~200	43,200	85,100	124,800	164,500	204,200	243,800	283,600	283,600
~220	44,100	86,900	127,600	168,200	208,900	249,400	290,100	290,100
~240	50,500	99,800	146,900	194,900	241,900	289,000	337,200	337,200
~260	51,400	101,600	149,700	198,600	246,600	294,500	343,700	343,700
~280	57,900	114,500	170,100	225,600	279,800	335,300	389,700	389,700
約1.5倍ヒダ	~86	~192	~296	~394	~493			

※片開きはW270cmまで

H	W	~65 1巾(片開き)	~148 2巾	~222 3巾	~296 4巾	~370 5巾	~444 6巾	~518 7巾	~592 8巾
~100	24,700	49,200	70,600	92,700	115,100	136,300	158,500	180,800	180,800
~120	25,500	50,800	73,000	96,000	119,100	141,100	164,200	187,300	187,300
~140	31,400	62,800	91,900	121,000	150,100	179,200	208,400	236,300	236,300
~160	32,200	64,400	94,300	124,200	154,100	184,000	214,000	242,700	242,700
~180	39,400	77,500	113,500	149,300	185,200	221,000	257,000	292,800	292,800
~200	40,200	79,100	115,900	152,500	189,200	225,			

TM-54037・54038

巾 ◇ 151 cm 価格 ◇ 8,800 円/m
組成 ◇ ポリエステル100%

リポート ◇ タテ 52.0 cm ヨコ 38.0 cm
寸法変化率 ◇ 水洗い/タテ -0.5% ヨコ -0.2%
ドライ/タテ -0.2% ヨコ -0.2%



取扱い表示 ◇ リ-30 30℃
防炎性能 ◇ (イ) ちて布使用
Made in Japan

H	W	~68 1巾(片開き)	~151 2巾	~226 3巾	~302 4巾	~377 5巾	~453 6巾	~528 7巾
~100	19,800	39,600	56,100	73,500	89,900	107,400	124,800	
~120	19,800	39,600	56,100	73,500	89,900	107,400	124,800	
~140	25,400	50,800	73,500	96,500	118,300	141,200	164,000	
~160	25,400	50,800	73,500	96,500	118,300	141,200	164,000	
~180	30,700	61,400	89,900	118,300	146,600	175,100	203,400	
~200	30,700	61,400	89,900	118,300	146,600	175,100	203,400	
~220	30,700	61,400	89,900	118,300	146,600	175,100	203,400	
~240	37,300	73,500	107,400	141,200	175,100	210,000	243,800	
~260	37,300	73,500	107,400	141,200	175,100	210,000	243,800	
~280	42,800	84,400	124,800	164,000	203,400	243,800	283,100	
約1.5倍ヒダ	~89	~200	~302	~402	~503			

※片開きはW270cmまで

H	W	~68 1巾(片開き)	~151 2巾	~226 3巾	~302 4巾	~377 5巾	~453 6巾	~528 7巾
~100	20,300	40,600	57,500	75,400	92,300	110,200	128,100	
~120	20,300	40,600	57,500	75,400	92,300	110,200	128,100	
~140	26,000	51,800	75,400	99,000	121,400	145,000	168,400	
~160	26,000	51,800	75,400	99,000	121,400	145,000	168,400	
~180	31,500	63,200	92,300	121,400	150,500	179,800	208,900	
~200	31,500	63,200	92,300	121,400	150,500	179,800	208,900	
~220	31,500	63,200	92,300	121,400	150,500	179,800	208,900	
~240	38,200	75,400	110,200	145,000	179,800	215,600	250,400	
~260	38,200	75,400	110,200	145,000	179,800	215,600	250,400	
~280	43,900	86,600	128,100	168,400	208,900	250,400	290,800	
約1.5倍ヒダ	~89	~200	~302	~402	~503			

※片開きはW270cmまで

H	W	~68 1巾(片開き)	~151 2巾	~226 3巾	~302 4巾	~377 5巾	~453 6巾	~528 7巾	~604 8巾
~100	19,400	38,700	54,600	71,600	87,600	104,500	121,500	137,400	
~120	19,400	38,700	54,600	71,600	87,600	104,500	121,500	137,400	
~140	24,700	49,300	71,600	93,900	115,100	137,400	159,600	182,000	
~160	24,700	49,300	71,600	93,900	115,100	137,400	159,600	182,000	
~180	30,000	60,000	87,600	115,100	142,700	170,400	197,900	225,500	
~200	30,000	60,000	87,600	115,100	142,700	170,400	197,900	225,500	
~220	30,000	60,000	87,600	115,100	142,700	170,400	197,900	225,500	
~240	36,300	71,600	104,500	137,400	170,400	204,300	237,200	270,100	
~260	36,300	71,600	104,500	137,400	170,400	204,300	237,200	270,100	
~280	41,700	82,200	121,500	159,600	197,900	237,200	275,400	314,600	
約1.5倍ヒダ	~89	~200	~302	~402	~503	~604	~704	~805	
フラット縫製	~131	~262	~413	~564					

H	W	~68 1巾(片開き)	~151 2巾	~226 3巾	~302 4巾	~377 5巾	~453 6巾	~528 7巾
~100	21,300	42,500	60,300	79,200	97,000	115,900	134,800	
~120	21,300	42,500	60,300	79,200	97,000	115,900	134,800	
~140	27,300	54,300	79,200	104,100	127,700	152,600	177,200	
~160	27,300	54,300	79,200	104,100	127,700	152,600	177,200	
~180	33,100	66,300	97,000	127,700	158,400	189,200	219,900	
~200	33,100	66,300	97,000	127,700	158,400	189,200	219,900	
~220	33,100	66,300	97,000	127,700	158,400	189,200	219,900	
~240	40,200	79,200	115,900	152,600	189,200	227,000	263,700	
~260	40,200	79,200	115,900	152,600	189,200	227,000	263,700	

※片開きはW300cmまで

		コード式				ドラム式								
H	W	30~45	~90	~140	~190	~240	30~45	~90	~140	~190	~240	~290	~340	~390
50~100	~140	22,400	26,300	30,800	46,600	51,200	25,400	29,300	33,800	49,600	54,200	61,900	78,000	82,800
~140	23,300	27,300	32,000	47,800	52,700	26,300	30,300	35,000	50,800	55,700	63,600	79,800	84,700	
~180	28,000	31,900	36,900	56,400	61,500	31,000	34,900	39,900	59,400	64,500	72,600	93,500	98,600	
~220	32,800	36,700	41,900	65,100	70,400	35,800	39,700	44,900	68,100	73,400	81,900	106,700	111,800	
~260	38,200	42,100	47,600	74,400	79,900	41,200	45,100	50,600	77,400	82,900	91,700	120,600	125,600	
~300	42,900	46,900	52,500	83,000	88,800	45,900	49,900	55,500	86,000	91,800	101,000	134,300	139,700	

※ドラム式：仕上り巾39cm以下の場合、仕上り丈は200cmまでとなります。

		コード式				ドラム式								
H	W	30~45	~90	~140	~190	~240	30~45	~90	~140	~190	~240	~290	~340	~390
50~100	~140	25,500	31,700	38,300	57,600	63,900	28,400	34,700	41,300	60,600	66,900	75,100	93,600	100,100
~140	26,500	33,100	40,200	60,000	66,900	29,500	36,100	43,200	63,000	69,900	78,500	97,300	104,100	
~180	31,400	38,600	46,100	70,300	77,900	34,400	41,600	49,100	73,300	80,900	89,800	113,900	121,200	
~220	36,500	44,000	52,000	80,600	88,800	39,500	47,000	55,000	83,600	91,800	101,000	129,300	136,900	
~260	42,300	50,500	59,100	92,300	101,200	45,300	53,500	62,100	95,300	104,200	113,900	146,600	154,800	
~300	47,500	56,200	65,500	103,200	112,800	50,500	59,200	68,500	106,200	115,800	126,000	164,000	172,600	

※ドラム式：仕上り巾39cm以下の場合、仕上り丈は200cmまでとなります。

H	W	~68 1巾(片開き)	~151 2巾	~226 3巾	~302 4巾	~377 5巾	~453 6巾	~528 7巾
~100	32,000	57,900	80,500	104,000	126,500	150,100	173,600	
~120	33,800	60,500	84,000	108,300	131,700	156,200	180,500	
~140	41,100	74,000	104,900	135,700	165,300	196,100	226,700	
~160	42,800	76,600	108,300	140,000	170,500	202,100	233,600	
~180	49,900	90,400	128,200	166,200	204,100	242,100	280,000	
~200	51,600	93,000	131,700	170,500	209,300	248,200	287,000	
~220	53,400	95,600	135,200	174,900	214,500	254,300	293,900	
~240	61,700	110,100	156,200	202,100	248,200	295,300	341,300	
~260	63,400	112,700	159,600	206,500	253,400	301,400	348,200	
~280	70,700	126,200	180,500	233,600	287,000	341,300	394,500	
約1.5倍ヒダ	~89	~200	~302	~402	~503			

※片開きはW270cmまで

H	W	~68 1巾(片開き)	~151 2巾	~226 3巾	~302 4巾	~377 5巾	~453 6巾	~528 7巾
~100	33,400	60,200	83,600	108,000	131,400	155,800	180,200	
~120	35,200	63,000	87,300	112,600	137,000	162,300	187,700	
~140	42,800	77,000	108,900	140,900	171,700	203,600	235,400	
~160	44,600	79,700	112,600	145,500	177,200	210,100	242,800	
~180	52,000	93,900	133,300	172,600	211,900	251,500	290,800	
~200	53,900	96,700	137,000	177,200	217,500	258,000	298,200	
~220	55,700	99,500	140,700	181,900	223,100	264,500	305,700	
~240	64,300	114,500	162,300	210,100	258,000	306,800	354,600	
~260	66,100	117,300	166,000	214,800	263,500	313,300	362,000	
~280	73,700	131,300	187,700	242,800	298,200	354,600	409,900	
約1.5倍ヒダ	~89	~200	~302	~402	~503			

※片開きはW270cmまで

H	W	~68 1巾(片開き)	~151 2巾	~226 3巾	~302 4巾	~377 5巾	~453 6巾	~528 7巾	~604 8巾
~100	30,800	55,800	77,300	100,000	121,700	144,200	166,900	188,500	
~120	32,400	58,200	80,600	104,000	126,500	149,900	173,400	195,800	
~140	39,300	71,200	100,800	130,400	158,900	188,500	218,000	247,700	
~160	40,900	73,600	104,000	134,400	163,700	194,100	224,400	254,900	
~180	47,900	86,800	123,300	159,700	196,200	232,800	269,200	305,700	
~200	49,500	89,200	126,500	163,700	201,100	238,500	275,700	313,000	
~220	51,100	91,600	129,800	167,800	205,900	244,200	282,200	320,300	
~240	59,000	105,700	149,900	194,100	238,500	283,700	328,000	372,200	
~260	60,600	108,100	153,100	198,200	243,300	289,400	334,400	379,500	
~280	67,700	121,100	173,400	224,400	275,700	328,000	379,100	431,300	
約1.5倍ヒダ	~89	~200	~302	~402	~503	~604	~704	~805	

※片開きはW270cmまで

TM-54039



巾 ◇ 100 cm 価格 ◇ 3,900 円/m リピート ◇ タテ 0.9 cm ヨコ 25.0 cm 取扱表示 ◇ リ-30 40 炎 1 2 3 4 5 6 7 8 9 10 11 12 13 14 15 16 17 18 19 20 21 22 23 24 25 26 27 28 29 30 31 32 33 34 35 36 37 38 39 40 41 42 43 44 45 46 47 48 49 50 51 52 53 54 55 56 57 58 59 60 61 62 63 64 65 66 67 68 69 70 71 72 73 74 75 76 77 78 79 80 81 82 83 84 85 86 87 88 89 90 91 92 93 94 95 96 97 98 99 100
 組成 ◇ ポリエステル100% 寸法変化率 ◇ 水洗い/タテ -0.3% ヨコ -0.5% 防炎性能 ◇ (イ) 形態安定加工
 ドライ/タテ -0.2% ヨコ -0.7% Made in Japan

H	W	~44	~100	~150	~200	~250	~300	~350	~400
		1巾(片開き)	2巾	3巾	4巾	5巾	6巾	7巾	8巾
~100		7,200	14,300	22,000	29,100	36,300	43,400	50,500	57,700
~120		8,200	16,400	24,500	32,700	41,400	49,500	57,700	65,800
~140		9,200	18,400	27,600	36,800	45,900	55,100	64,300	73,500
~160		10,200	21,000	31,200	41,400	51,600	61,800	72,000	82,200
~180		11,300	23,000	34,200	45,400	56,700	67,900	79,100	90,300
~200		12,300	24,500	36,800	49,500	61,800	74,000	86,200	98,500
~220		13,300	26,600	39,800	53,100	66,300	79,600	92,900	106,100
~240		14,300	29,100	43,400	57,700	72,000	86,200	100,500	114,800
~260		15,300	31,200	46,500	61,800	77,100	92,400	107,700	123,000
~280		16,400	32,700	49,500	65,800	82,200	98,500	114,800	131,100
約1.5倍ヒダ		~56	~120	~200	~266	~333	~400	~466	~533
フラット約1倍ヒダ		~80	~160	~260	~360	~460	~560		

H	W	~44	~100	~150	~200	~250	~300	~350	~400
		1巾(片開き)	2巾	3巾	4巾	5巾	6巾	7巾	8巾
~100		7,500	14,900	22,800	30,300	37,700	45,100	52,500	59,900
~120		8,500	17,000	25,500	34,000	43,000	51,500	59,900	68,400
~140		9,600	19,100	28,700	38,200	47,700	57,300	66,800	76,400
~160		10,600	21,800	32,400	43,000	53,600	64,200	74,800	85,400
~180		11,700	23,900	35,600	47,200	58,900	70,500	82,200	93,900
~200		12,800	25,500	38,200	51,500	64,200	76,900	89,600	102,300
~220		13,800	27,600	41,400	55,200	68,900	82,700	96,500	110,300
~240		14,900	30,300	45,100	59,900	74,800	89,600	104,500	119,300
~260		15,900	32,400	48,300	64,200	80,100	96,000	111,900	127,800
~280		17,000	34,000	51,500	68,400	85,400	102,300	119,300	136,300
約1.5倍ヒダ		~56	~120	~200	~266	~333	~400	~466	~533

※片開きはW270cmまで

H	W	~44	~100	~150	~200	~250	~300	~350	~400
		1巾(片開き)	2巾	3巾	4巾	5巾	6巾	7巾	8巾
~100		7,700	15,400	23,700	31,400	39,100	46,800	54,500	62,200
~120		8,800	17,600	26,400	35,200	44,600	53,400	62,200	71,000
~140		9,900	19,800	29,700	39,600	49,500	59,400	69,300	79,200
~160		11,000	22,600	33,600	44,600	55,600	66,600	77,600	88,600
~180		12,100	24,800	36,900	49,000	61,100	73,200	85,300	97,400
~200		13,200	26,400	39,600	53,400	66,600	79,800	93,000	106,200
~220		14,300	28,600	42,900	57,200	71,500	85,800	100,100	114,400
~240		15,400	31,400	46,800	62,200	77,600	93,000	108,400	123,800
~260		16,500	33,600	50,100	66,600	83,100	99,600	116,100	132,600
~280		17,600	35,200	53,400	71,000	88,600	106,200	123,800	141,400
約1.5倍ヒダ		~56	~120	~200	~266	~333	~400	~466	~533

※片開きはW270cmまで

ナチュユール

TM-54040~54042



巾 ◇ 150cm 価格 ◇ 4,400円/m
組成 ◇ ポリエステル100%

リポート ◇ タテ cm ヨコ cm
寸法変化率 ◇ 水洗い/タテ -0.3% ヨコ 0.0%
ドライ/タテ -0.1% ヨコ -0.3%

取扱い表示 ◇ リ-30 40 30 30 30 30 30 30
防炎性能 ◇ (イ) ちて布使用
Made in Japan

H	W	~67 1巾(片開き)	~150 2巾	~225 3巾	~300 4巾	~375 5巾	~450 6巾	~525 7巾
~100		10,600	21,200	30,300	39,400	48,500	57,600	66,700
~120		11,900	23,800	34,200	44,600	55,000	65,400	75,800
~140		13,200	26,400	38,100	49,800	61,500	73,200	84,900
~160		14,500	29,000	42,000	55,000	68,000	81,000	94,000
~180		15,800	31,600	45,900	60,200	74,500	88,800	103,100
~200		17,100	34,200	49,800	65,400	81,000	96,600	112,200
~220		18,400	36,800	53,700	70,600	87,500	104,400	121,300
~240		19,700	39,400	57,600	75,800	94,000	112,200	130,400
~260		21,000	42,000	61,500	81,000	100,500	120,000	139,500
~280		22,300	44,600	65,400	86,200	107,000	127,800	148,600
約1.5倍ヒダ		~88	~200	~300	~400	~500		

※片開きはW270cmまで

H	W	~67 1巾(片開き)	~150 2巾	~225 3巾	~300 4巾	~375 5巾	~450 6巾	~525 7巾
~100		11,000	22,000	31,600	41,100	50,600	60,100	69,600
~120		12,400	24,800	35,600	46,500	57,400	68,300	79,200
~140		13,800	27,500	39,700	52,000	64,200	76,400	88,700
~160		15,100	30,200	43,800	57,400	71,000	84,600	98,200
~180		16,500	32,900	47,900	62,800	77,800	92,800	107,700
~200		17,800	35,600	52,000	68,300	84,600	100,900	117,200
~220		19,200	38,400	56,000	73,700	91,400	109,100	126,800
~240		20,600	41,100	60,100	79,200	98,200	117,200	136,300
~260		21,900	43,800	64,200	84,600	105,000	125,400	145,800
~280		23,300	46,500	68,300	90,000	111,800	133,600	155,300
約1.5倍ヒダ		~88	~200	~300	~400	~500		

※片開きはW270cmまで

H	W	~67 1巾(片開き)	~150 2巾	~225 3巾	~300 4巾	~375 5巾	~450 6巾	~525 7巾	~600 8巾
~100		10,200	20,400	29,000	37,700	46,400	55,100	63,800	72,400
~120		11,400	22,800	32,800	42,700	52,600	62,500	72,400	82,400
~140		12,700	25,300	36,500	47,600	58,800	70,000	81,100	92,300
~160		13,900	27,800	40,200	52,600	65,000	77,400	89,800	102,200
~180		15,200	30,300	43,900	57,600	71,200	84,800	98,500	112,100
~200		16,400	32,800	47,600	62,500	77,400	92,300	107,200	122,000
~220		17,600	35,200	51,400	67,500	83,600	99,700	115,800	132,000
~240		18,900	37,700	55,100	72,400	89,800	107,200	124,500	141,900
~260		20,100	40,200	58,800	77,400	96,000	114,600	133,200	151,800
~280		21,400	42,700	62,500	82,400	102,200	122,000	141,900	161,700
約1.5倍ヒダ		~88	~200	~300	~400	~500	~600	~700	~800
フラット前ヒダ		~130	~260	~410	~560				

H	W	~67 1巾(片開き)	~150 2巾	~225 3巾	~300 4巾	~375 5巾	~450 6巾	~525 7巾	~600 8巾
~100		11,900	23,700	34,100	44,400	54,800	65,200	75,500	85,900
~120		13,400	26,700	38,500	50,400	62,200	74,000	85,900	97,700
~140		14,800	29,600	43,000	56,300	69,600	82,900	96,200	109,600
~160		16,300	32,600	47,400	62,200	77,000	91,800	106,600	121,400
~180		17,800	35,600	51,800	68,100	84,400	100,700	117,000	133,200
~200		19,300	38,500	56,300	74,000	91,800	109,600	127,300	145,100
~220		20,800	41,500	60,700	80,000	99,200	118,400	137,700	156,900
~240		22,200	44,400	65,200	85,900	106,600	127,300	148,000	168,800
~260		23,700	47,400	69,600	91,800	114,000	136,200	158,400	180,600

※片開きはW300cmまで

		コード式				ドラム式								
H	W	30~45	~90	~140	~240	30~45	~90	~140	~190	~240	~290	~340	~390	
50~100		14,700	18,700	23,300	31,800	36,500	17,700	21,700	26,300	34,800	39,500	46,700	56,100	60,800
~140		17,100	21,200	25,900	36,000	40,900	20,100	24,200	28,900	39,000	43,900	51,500	62,400	67,300
~180		19,500	23,600	28,600	40,200	45,300	22,500	26,600	31,600	43,200	48,300	56,000	68,600	73,600
~220		21,900	26,100	31,300	44,400	49,700	24,900	29,100	34,300	47,400	52,700	60,700	74,900	80,000
~260		24,300	28,500	33,900	48,500	54,100	27,300	31,500	36,900	51,500	57,100	65,200	81,300	86,300
~300		26,700	31,000	36,600	52,700	58,500	29,700	34,000	39,600	55,700	61,500	70,000	87,400	92,800

※ドラム式：仕上り巾39cm以下の場合、仕上り丈は200cmまでとなります。

		コード式	
H	W	18~30	
50~100		19,300	
~140		22,200	
~180		24,600	
~220		27,500	
~240		29,200	

		コード式				ドラム式								
H	W	30~45	~90	~140	~240	30~45	~90	~140	~190	~240	~290	~340	~390	
50~100		17,500	23,800	30,400	41,700	48,100	20,500	26,800	33,400	44,700	51,100	59,300	70,600	77,200
~140		20,100	26,800	33,900	47,300	54,300	23,100	29,800	36,900	50,300	57,300	65,800	79,100	85,900
~180		22,700	29,900	37,400	52,900	60,400	25,700	32,900	40,400	55,900	63,400	72,300	87,800	95,100
~220		25,400	32,900	40,900	58,500	66,600	28,400	35,900	43,900	61,500	69,600	78,900	96,000	103,700
~260		28,100	36,200	44,900	64,600	73,500	31,100	39,200	47,900	67,600	76,500	86,200	105,500	113,600
~300		30,900	39,600	48,800	70,700	80,300	33,900	42,600	51,800	73,700	83,300	93,600	114,900	123,500

※ドラム式：仕上り巾39cm以下の場合、仕上り丈は200cmまでとなります。

		38mm (片開き/タッセルなし)					
H	W	~72	~100	~127	~155	~183	
~100		15,100	23,800	28,000	30,100	38,800	
~140		16,900	27,500	31,700	33,800	44,400	
~180		18,800	31,300	35,500	37,600	50,100	
~220		20,700	35,100	39,300	41,400	55,800	
~260		22,600	38,900	43,100	45,200	61,400	
~300		24,500	42,600	46,800	48,900	67,100	
26mm		-2,800	-2,100	-4,900	-4,200	-4,900	
18mm		-4,900	-5,600	-9,100	-9,800	-10,500	

※生地を伸ばした状態のサイズでご発注ください。

		スプリング・チェーンタイプ				
H	W	30~60	~80	~100	~120	~140
50~80		30,100	32,600	34,600	35,800	37,500
~120		32,600	35,700	37,700	38,800	40,700
~160		35,100	38,900	40,900	42,100	43,400
~200		38,700	41,700	43,900	45,100	46,400
~240			44,700	47,000	48,200	49,600

※丈は巾の3倍までが限度です。
※ロールソフト加工品は非防炎品になります。

		ストレートバランス				
H	W	~100	~150	~200	~250	~300
~40		11,000	17,500	21,900	26,300	32,800

※マジックテープ仕様・裏面スポンジ付の価格になります。

H	W	~100	~150	~200	~250	~300
~40		9,100	13,000	17,000	22,000	23,500

※マジックテープ仕様の価格になります。

プレーン		パイピング	
サイズ		サイズ	
40x40	45x45	40x40	45x45
6,400	7,800	7,300	8,700
フリール付			
40x40	45x45	40x40	45x45
10,300	12,000	9,900	11,700

※中材込みの価格になります。

TM-54043・54044



巾 ◇ 150cm 価格 ◇ 4,800円/m リポート ◇ タテ cm ヨコ 25.2cm 取扱表示 ◇ リ-30 40 防炎性能 ◇ (イ) 乾燥機使用可 乾燥機使用不可 乾燥機使用不可 乾燥機使用不可 乾燥機使用不可 乾燥機使用不可 乾燥機使用不可 乾燥機使用不可
 組成 ◇ ポリエステル100% 寸法変化率 ◇ 水洗い/タテ -0.5% ヨコ -0.2% ドライ/タテ 0.0% ヨコ 0.0% Made in Japan

ナチュラル

H	W	~67 1巾(片開き)	~150 2巾	~225 3巾	~300 4巾	~375 5巾	~450 6巾	~525 7巾
~100		11,300	22,500	32,100	41,800	51,500	61,100	70,800
~120		12,600	25,200	36,300	47,300	58,400	69,400	80,400
~140		14,000	28,000	40,400	52,800	65,300	77,700	90,100
~160		15,400	30,800	44,600	58,400	72,200	86,000	99,800
~180		16,800	33,500	48,700	63,900	79,100	94,200	109,400
~200		18,200	36,300	52,800	69,400	86,000	102,500	119,100
~220		19,500	39,000	57,000	74,900	92,900	110,800	128,700
~240		20,900	41,800	61,100	80,400	99,800	119,100	138,400
~260		22,300	44,600	65,300	86,000	106,700	127,400	148,100
~280		23,700	47,300	69,400	91,500	113,600	135,600	157,700
約1.5倍ヒダ		~88	~200	~300	~400	~500		

※片開きはW270cmまで

H	W	~67 1巾(片開き)	~150 2巾	~225 3巾	~300 4巾	~375 5巾	~450 6巾	~525 7巾
~100		11,700	23,300	33,400	43,500	53,600	63,600	73,700
~120		13,100	26,200	37,700	49,200	60,800	72,300	83,800
~140		14,600	29,100	42,000	55,000	68,000	80,900	93,900
~160		16,000	32,000	46,400	60,800	75,200	89,600	104,000
~180		17,400	34,800	50,700	66,500	82,400	98,200	114,000
~200		18,900	37,700	55,000	72,300	89,600	106,800	124,100
~220		20,300	40,600	59,300	78,000	96,800	115,500	134,200
~240		21,800	43,500	63,600	83,800	104,000	124,100	144,300
~260		23,200	46,400	68,000	89,600	111,200	132,800	154,400
~280		24,600	49,200	72,300	95,300	118,400	141,400	164,400
約1.5倍ヒダ		~88	~200	~300	~400	~500		

※片開きはW270cmまで

H	W	~67 1巾(片開き)	~150 2巾	~225 3巾	~300 4巾	~375 5巾	~450 6巾	~525 7巾	~600 8巾
~100		10,800	21,600	30,900	40,100	49,400	58,600	67,800	77,100
~120		12,200	24,300	34,800	45,400	56,000	66,500	77,100	87,600
~140		13,500	26,900	38,800	50,700	62,600	74,400	86,300	98,200
~160		14,800	29,600	42,800	56,000	69,200	82,400	95,600	108,800
~180		16,100	32,200	46,700	61,200	75,800	90,300	104,800	119,300
~200		17,400	34,800	50,700	66,500	82,400	98,200	114,000	129,900
~220		18,800	37,500	54,600	71,800	89,000	106,100	123,300	140,400
~240		20,100	40,100	58,600	77,100	95,600	114,000	132,500	151,000
~260		21,400	42,800	62,600	82,400	102,200	122,000	141,800	161,600
~280		22,700	45,400	66,500	87,600	108,800	129,900	151,000	172,100
約1.5倍ヒダ		~88	~200	~300	~400	~500	~600	~700	~800
フラット前1倍ヒダ		~130	~260	~410	~560				

H	W	~67 1巾(片開き)	~150 2巾	~225 3巾	~300 4巾	~375 5巾	~450 6巾	~525 7巾	~600 8巾
~100		12,500	25,000	35,900	46,800	57,800	68,700	79,600	90,500
~120		14,100	28,100	40,600	53,100	65,600	78,000	90,500	103,000
~140		15,600	31,200	45,300	59,300	73,400	87,400	101,400	115,500
~160		17,200	34,400	50,000	65,600	81,200	96,800	112,400	128,000
~180		18,800	37,500	54,600	71,800	89,000	106,100	123,300	140,400
~200		20,300	40,600	59,300	78,000	96,800	115,500	134,200	152,900
~220		21,900	43,700	64,000	84,300	104,600	124,800	145,100	165,400
~240		23,400	46,800	68,700	90,500	112,400	134,200	156,000	177,900
~260		25,000	50,000	73,400	96,800	120,200	143,600	167,000	190,400

※片開きはW300cmまで

		コード式				ドラム式								
H	W	30~45	~90	~140	~240	30~45	~90	~140	~190	~240	~290	~340	~390	
50~100		15,100	19,100	23,700	32,600	37,300	18,100	22,100	26,700	35,600	40,300	47,600	57,300	62,100
~140		17,700	21,700	26,500	37,000	42,000	20,700	24,700	29,500	40,000	45,000	52,600	64,100	69,000
~180		20,200	24,300	29,300	41,500	46,600	23,200	27,300	32,300	44,500	49,600	57,400	70,600	75,600
~220		22,800	26,900	32,100	46,000	51,300	25,800	29,900	35,100	49,000	54,300	62,300	77,400	82,500
~260		25,200	29,500	34,900	50,400	56,000	28,200	32,500	37,900	53,400	59,000	67,100	84,200	89,200
~300		27,800	32,100	37,700	54,900	60,700	30,800	35,100	40,700	57,900	63,700	72,200	90,700	96,100

※ドラム式: 仕上り巾39cm以下の場合、仕上り丈は200cmまでとなります。

		コード式
H	W	18~30
50~100		19,700
~140		22,700
~180		25,200
~220		28,300
~240		30,000

		スプリング・チェーンタイプ				
H	W	30~60	~80	~100	~120	~140
50~80		30,500	33,000	35,000	36,200	37,900
~120		33,100	36,200	38,200	39,300	41,200
~160		35,700	39,500	41,500	42,700	44,000
~200		39,500	42,500	44,700	45,900	47,200
~240			45,600	47,900	49,100	50,500

※丈は巾の3倍までが限度です。
 ※ロールソフト加工品は非防炎品になります。

		(片開き/タッセルなし)				
H	W	~72	~100	~127	~155	~183
~100		15,500	24,700	28,900	31,000	40,100
~140		17,500	28,700	32,900	35,000	46,200
~180		19,500	32,700	36,900	39,000	52,200
~220		21,600	36,800	41,000	43,100	58,300
~260		23,600	40,800	45,000	47,100	64,300
~300		25,600	44,800	49,000	51,100	70,400
26mm		-2,800	-2,100	-4,900	-4,200	-4,900
18mm		-4,900	-5,600	-9,100	-9,800	-10,500

※生地を伸ばした状態のサイズでご発注ください。

		ストレートバランス				
H	W	~100	~150	~200	~250	~300
~40		11,200	17,900	22,300	26,700	33,400

※マジックテープ仕様・裏面スポンジ付の価格になります。

		三つ山・箱ヒダバランス (約2.5倍ヒダ)				
H	W	~100	~150	~200	~250	~300
~40		9,500	13,700	17,900	23,100	24,600

※マジックテープ仕様の価格になります。

TM-54045・54046



巾 ◇ 150cm 価格 ◇ 6,000円/m リポート ◇ タテ cm ヨコ 25.0cm 取扱い表示 ◇ リ-30 30 40 50 60 70 80 90 100 110 120 130 140 150 160 170 180 190 200 210 220 230 240 250 260 270 280 290 300 310 320 330 340 350 360 370 380 390 400 410 420 430 440 450 460 470 480 490 500 510 520 530 540 550 560 570 580 590 600 610 620 630 640 650 660 670 680 690 700 710 720 730 740 750 760 770 780 790 800 810 820 830 840 850 860 870 880 890 900 910 920 930 940 950 960 970 980 990 1000
 組成 ◇ ポリエステル100% 寸法変化率 ◇ 水洗い/タテ 0.0% ヨコ 0.0% 防炎性能 ◇ (イ) であて布使用
 ドライ/タテ 0.0% ヨコ 0.0% Made in Japan

H	W	~67 1巾(片開き)	~150 2巾	~225 3巾	~300 4巾	~375 5巾	~450 6巾	~525 7巾
~100		13,200	26,300	37,700	49,000	60,300	71,700	83,000
~120		14,800	29,600	42,500	55,500	68,400	81,400	94,400
~140		16,400	32,800	47,400	62,000	76,500	91,100	105,700
~160		18,000	36,000	52,200	68,400	84,600	100,800	117,000
~180		19,700	39,300	57,100	74,900	92,700	110,600	128,400
~200		21,300	42,500	62,000	81,400	100,800	120,300	139,700
~220		22,900	45,800	66,800	87,900	108,900	130,000	151,100
~240		24,500	49,000	71,700	94,400	117,000	139,700	162,400
~260		26,100	52,200	76,500	100,800	125,100	149,400	173,700
~280		27,800	55,500	81,400	107,300	133,200	159,200	185,100
約1.5倍ヒダ		~88	~200	~300	~400	~500		

※片開きはW270cmまで

H	W	~67 1巾(片開き)	~150 2巾	~225 3巾	~300 4巾	~375 5巾	~450 6巾	~525 7巾
~100		13,600	27,200	38,900	50,700	62,400	74,200	86,000
~120		15,300	30,500	44,000	57,400	70,800	84,300	97,700
~140		17,000	33,900	49,000	64,100	79,200	94,400	109,500
~160		18,600	37,200	54,000	70,800	87,600	104,400	121,200
~180		20,300	40,600	59,100	77,600	96,000	114,500	133,000
~200		22,000	44,000	64,100	84,300	104,400	124,600	144,800
~220		23,700	47,300	69,200	91,000	112,800	134,700	156,500
~240		25,400	50,700	74,200	97,700	121,200	144,800	168,300
~260		27,000	54,000	79,200	104,400	129,600	154,800	180,000
~280		28,700	57,400	84,300	111,200	138,000	164,900	191,800
約1.5倍ヒダ		~88	~200	~300	~400	~500		

※片開きはW270cmまで

H	W	~67 1巾(片開き)	~150 2巾	~225 3巾	~300 4巾	~375 5巾	~450 6巾	~525 7巾	~600 8巾
~100		12,800	25,500	36,400	47,300	58,200	69,200	80,100	91,000
~120		14,300	28,600	41,100	53,600	66,000	78,500	91,000	103,500
~140		15,900	31,700	45,800	59,800	73,800	87,900	101,900	116,000
~160		17,400	34,800	50,400	66,000	81,600	97,200	112,800	128,400
~180		19,000	38,000	55,100	72,300	89,400	106,600	123,800	140,900
~200		20,600	41,100	59,800	78,500	97,200	116,000	134,700	153,400
~220		22,100	44,200	64,500	84,800	105,000	125,300	145,600	165,900
~240		23,700	47,300	69,200	91,000	112,800	134,700	156,500	178,400
~260		25,200	50,400	73,800	97,200	120,600	144,000	167,400	190,800
~280		26,800	53,600	78,500	103,500	128,400	153,400	178,400	203,300
約1.5倍ヒダ		~88	~200	~300	~400	~500	~600	~700	~800
フラット前ヒダ		~130	~260	~410	~560				

H	W	~67 1巾(片開き)	~150 2巾	~225 3巾	~300 4巾	~375 5巾	~450 6巾	~525 7巾	~600 8巾
~100		14,400	28,800	41,400	54,000	66,600	79,200	91,800	104,400
~120		16,200	32,400	46,800	61,200	75,600	90,000	104,400	118,800
~140		18,000	36,000	52,200	68,400	84,600	100,800	117,000	133,200
~160		19,800	39,600	57,600	75,600	93,600	111,600	129,600	147,600
~180		21,600	43,200	63,000	82,800	102,600	122,400	142,200	162,000
~200		23,400	46,800	68,400	90,000	111,600	133,200	154,800	176,400
~220		25,200	50,400	73,800	97,200	120,600	144,000	167,400	190,800
~240		27,000	54,000	79,200	104,400	129,600	154,800	180,000	205,200
~260		28,800	57,600	84,600	111,600	138,600	165,600	192,600	219,600

※片開きはW300cmまで

ソフト		style no.S01 ロールソフト				
スプリング・チェーンタイプ						
H	W	30~60	~80	~100	~120	~140
50~80		31,600	34,100	36,100	37,300	39,000
~120		34,600	37,700	39,700	40,800	42,700
~160		37,600	41,400	43,400	44,600	45,900
~200		41,800	44,800	47,000	48,200	49,500
~240			48,300	50,600	51,800	53,200

※丈は巾の3倍までが限度です。
 ※ロールソフト加工品は非防炎品になります。

ナ
チ
ユ
ラ
ル

TM-54047・54048



巾 ◇ 148 cm 価格 ◇ 6,000円/m
組 成 ◇ ポリエステル100%

リポート ◇ タテ 49.5 cm ヨコ 49.5 cm
寸法変化率 ◇ 水洗い/タテ 0.0% ヨコ 0.0%
ドライ/タテ -0.2% ヨコ 0.0%

取扱い表示 ◇ リ-30 40 50 60 70 80 90 100 110 120 130 140 150 160 170 180 190 200
防炎性能 ◇ -
Made in Japan

ナチュラル

標準仕様 形態安定加工価格表 約2倍ヒダ (タッセル含む)

H	W	~65 1巾(片開き)	~148 2巾	~222 3巾	~296 4巾	~370 5巾	~444 6巾	~518 7巾
~100		13,900	27,800	40,000	52,100	64,200	76,300	87,600
~120		18,000	35,900	50,000	68,200	83,600	99,700	115,900
~140		18,000	35,900	52,100	68,200	83,600	99,700	115,900
~160		18,000	35,900	52,100	68,200	83,600	99,700	115,900
~180		22,000	44,000	64,200	83,600	103,800	124,000	144,200
~200		22,000	44,000	64,200	83,600	103,800	124,000	144,200
~220		26,000	52,100	76,300	99,700	124,000	148,100	171,600
~240		26,000	52,100	76,300	99,700	124,000	148,100	171,600
~260		26,000	52,100	76,300	99,700	124,000	148,100	171,600
~280		30,100	60,200	87,600	115,900	144,200	171,600	199,800
約1.5倍ヒダ		~86	~192	~296	~394	~493		

※片開きはW270cmまで

プライム縫製仕様価格表 約2倍ヒダ (タッセル含む)

H	W	~65 1巾(片開き)	~148 2巾	~222 3巾	~296 4巾	~370 5巾	~444 6巾	~518 7巾
~100		14,400	28,700	41,400	53,900	66,400	78,900	90,700
~120		18,600	37,100	53,900	70,500	86,600	103,200	120,000
~140		18,600	37,100	53,900	70,500	86,600	103,200	120,000
~160		18,600	37,100	53,900	70,500	86,600	103,200	120,000
~180		22,800	45,500	66,400	86,600	107,500	128,400	149,300
~200		22,800	45,500	66,400	86,600	107,500	128,400	149,300
~220		26,900	53,900	78,900	103,200	128,400	153,400	177,700
~240		26,900	53,900	78,900	103,200	128,400	153,400	177,700
~260		26,900	53,900	78,900	103,200	128,400	153,400	177,700
~280		31,200	62,300	90,700	120,000	149,300	177,700	207,000
約1.5倍ヒダ		~86	~192	~296	~394	~493		

※片開きはW270cmまで

レギュラー縫製仕様価格表 約2倍ヒダ (タッセル含む)

H	W	~65 1巾(片開き)	~148 2巾	~222 3巾	~296 4巾	~370 5巾	~444 6巾	~518 7巾	~592 8巾
~100		13,500	26,900	38,700	50,300	62,000	73,600	84,500	96,200
~120		17,400	34,700	50,300	65,800	80,700	96,200	111,800	127,200
~140		17,400	34,700	50,300	65,800	80,700	96,200	111,800	127,200
~160		17,400	34,700	50,300	65,800	80,700	96,200	111,800	127,200
~180		21,300	42,500	62,000	80,700	100,100	119,600	139,000	157,600
~200		21,300	42,500	62,000	80,700	100,100	119,600	139,000	157,600
~220		25,100	50,300	73,600	96,200	119,600	142,800	165,400	188,700
~240		25,100	50,300	73,600	96,200	119,600	142,800	165,400	188,700
~260		25,100	50,300	73,600	96,200	119,600	142,800	165,400	188,700
~280		29,100	58,100	84,500	111,800	139,000	165,400	192,600	219,800
約1.5倍ヒダ		~86	~192	~296	~394	~493	~592	~690	~789
フラット約1倍ヒダ		~128	~256	~404	~552				

形状記憶加工価格表 約2倍ヒダ (タッセル含む)

H	W	~65 1巾(片開き)	~148 2巾	~222 3巾	~296 4巾	~370 5巾	~444 6巾	~518 7巾	~592 8巾
~100		15,200	30,400	44,000	57,400	70,800	84,200	96,800	110,200
~120		19,800	39,400	57,400	75,200	92,400	110,200	128,200	146,000
~140		19,800	39,400	57,400	75,200	92,400	110,200	128,200	146,000
~160		19,800	39,400	57,400	75,200	92,400	110,200	128,200	146,000
~180		24,200	48,400	70,800	92,400	114,800	137,200	159,600	181,000
~200		24,200	48,400	70,800	92,400	114,800	137,200	159,600	181,000
~220		28,600	57,400	84,200	110,200	137,200	164,000	190,000	216,800
~240		28,600	57,400	84,200	110,200	137,200	164,000	190,000	216,800
~260		28,600	57,400	84,200	110,200	137,200	164,000	190,000	216,800

※片開きはW300cmまで

style no.60 プレーンシェード

H	W	コード式					ドラム式							
		30~45	~90	~140	~190	~240	30~45	~90	~140	~190	~240	~290	~340	~390
50~100		18,000	21,900	34,200	38,000	42,700	21,000	24,900	37,200	41,000	45,700	60,900	65,700	70,400
~140		21,500	25,500	40,500	44,300	49,200	24,500	28,500	43,500	47,300	52,200	70,300	75,200	80,100
~180		22,300	26,300	41,700	45,500	50,700	25,300	29,300	44,700	48,500	53,700	71,800	76,800	81,800
~220		25,800	29,900	48,000	51,800	57,200	28,800	32,900	51,000	54,800	60,200	81,200	86,400	91,500
~260		29,300	33,400	54,300	58,100	63,600	32,300	36,400	57,300	61,100	66,600	90,500	95,900	100,900
~300		32,800	36,900	60,600	64,400	70,200	35,800	39,900	63,600	67,400	73,200	99,400	104,700	110,100

※ドラム式:仕上り巾39cm以下の場合、仕上り丈は200cmまでとなります。

style no.63 シャープシェード

H	W	コード式					ドラム式							
		30~45	~90	~140	~190	~240	30~45	~90	~140	~190	~240	~290	~340	~390
50~100		20,800	27,100	41,800	48,400	54,800	23,800	30,100	44,800	51,400	57,800	74,100	80,600	87,200
~140		24,600	31,300	49,200	56,200	63,200	27,600	34,300	52,200	59,200	66,200	85,500	92,500	99,300
~180		25,600	32,700	51,100	58,700	66,200	28,600	35,700	54,100	61,700	69,200	88,900	96,400	103,700
~220		29,400	36,900	58,400	66,500	74,600	32,400	39,900	61,400	69,500	77,600	100,400	108,000	115,700
~260		33,200	41,400	66,200	74,800	83,700	36,200	44,400	69,200	77,800	86,700	112,600	120,800	128,900
~300		37,100	45,800	74,000	83,200	92,800	40,100	48,800	77,000	86,200	95,800	124,400	133,000	141,700

※ドラム式:仕上り巾39cm以下の場合、仕上り丈は200cmまでとなります。

形態安定加工 推奨裏地付価格表(推奨裏地 TM-54419~54423) 約2倍ヒダ (タッセル含む)

H	W	~65 1巾(片開き)	~148 2巾	~222 3巾	~296 4巾	~370 5巾	~444 6巾	~518 7巾
~100		20,000	40,000	58,300	76,500	94,700	112,900	130,300
~120		25,000	49,900	73,000	96,100	118,400	141,500	164,700
~140		25,900	51,600	75,600	99,600	122,800	146,700	170,800
~160		26,700	53,300	78,200	103,000	127,100	151,900	176,800
~180		31,600	63,200	93,000	121,900	151,700	181,500	211,200
~200		32,500	64,900	95,600	125,400	156,000	186,700	217,300
~220		37,400	74,800	110,300	145,000	180,600	216,000	250,800
~240		38,200	76,500	112,900	148,500	184,900	221,200	256,900
~260		39,100	78,200	115,500	151,900	189,300	226,400	263,000
~280		44,100	88,100	129,400	171,600	213,800	255,200	297,300
約1.5倍ヒダ		~86	~192	~296	~394	~493		

※片開きはW270cmまで

プライム縫製仕様 推奨裏地付価格表(推奨裏地 TM-54419~54423) 約2倍ヒダ (タッセル含む)

H	W	~65 1巾(片開き)	~148 2巾	~222 3巾	~296 4巾	~370 5巾	~444 6巾	~518 7巾
~100		21,000	41,800	61,000	80,000	99,000	118,000	136,300
~120		26,100	52,000	76,300	100,300	123,800	147,900	172,100
~140		27,000	53,900	79,100	104,000	128,500	153,500	178,600
~160		27,900	55,700	81,800	107,700	133,100	159,000	185,100
~180		33,100	66,000	97,100	127,600	158,700	189,800	221,000
~200		34,000	67,900	99,900	131,300	163,300	195,400	227,500
~220		39,000	78,100	115,200	151,600	188,900	226,000	262,400
~240		40,000	80,000	118,000	155,300	193,500	231,600	268,900
~260		40,900	81,800	120,800	159,000	198,200	237,100	275,400
~280		46,100	92,100	135,400	179,600	223,700	267,000	311,200
約1.5倍ヒダ		~86	~192	~296	~394	~493		

※片開きはW270cmまで

レギュラー縫製仕様 推奨裏地付価格表(推奨裏地 TM-54419~54423) 約2倍ヒダ (タッセル含む)

H	W	~65 1巾(片開き)	~148 2巾	~222 3巾	~296 4巾	~370 5巾	~444 6巾	~518 7巾	~592 8巾
~100		19,200	38,300	55,800	73,000	90,400	107,700	124,200	141,600
~120		23,900	47,700	69,800	91,800	113,100	135,100	157,200	179,100
~140		24,700	49,300	72,200	95,000	117,200	140,000	162,900	185,600
~160		25,500	50,900	74,600	98,200	121,200	144,800	168,500	192,000
~180		30,300	60,400	88,800	116,400	144,700	173,100	201,400	228,900
~200		31,100	62,000	91,200	119,600	148,700	178,000	207,100	235,400
~220		35,700	71,400	105,200	138,400	172,300	206,000	239,200	273,000
~240		36,500	73,000	107,700	141,600	176,300	210,900	244,800	

TM-54049・54050



巾 ◇ 150cm 価格 ◇ 3,600円/m
組成 ◇ ポリエステル100%

リポート ◇ タテ 61.0cm ヨコ 75.0cm
寸法変化率 ◇ 水洗い/タテ -0.7% ヨコ -0.3%
ドライ/タテ -0.3% ヨコ 0.0%

取扱い表示 ◇ リ-30
防炎性能 ◇ (イ)
Made in Japan

H	W	~67 1巾(片開き)	~150 2巾	~225 3巾	~300 4巾	~375 5巾	~450 6巾	~525 7巾
~100		12,300	23,800	34,100	44,900	55,100	65,400	76,300
~120		12,300	23,800	34,100	44,900	55,100	65,400	76,300
~140		12,300	23,800	34,100	44,900	55,100	65,400	76,300
~160		15,700	30,700	44,900	58,500	72,200	86,500	100,200
~180		15,700	30,700	44,900	58,500	72,200	86,500	100,200
~200		15,700	30,700	44,900	58,500	72,200	86,500	100,200
~220		19,100	37,500	55,100	72,200	90,000	107,100	124,700
~240		19,100	37,500	55,100	72,200	90,000	107,100	124,700
~260		19,100	37,500	55,100	72,200	90,000	107,100	124,700
~280		22,500	44,900	65,400	86,500	107,100	128,100	149,200
約1.5倍ヒダ		~88	~200	~300	~400	~500		

※片開きはW270cmまで

H	W	~67 1巾(片開き)	~150 2巾	~225 3巾	~300 4巾	~375 5巾	~450 6巾	~525 7巾
~100		12,800	25,000	35,800	47,100	57,900	68,700	80,200
~120		12,800	25,000	35,800	47,100	57,900	68,700	80,200
~140		12,800	25,000	35,800	47,100	57,900	68,700	80,200
~160		16,400	32,200	47,100	61,500	75,900	91,000	105,400
~180		16,400	32,200	47,100	61,500	75,900	91,000	105,400
~200		16,400	32,200	47,100	61,500	75,900	91,000	105,400
~220		20,000	39,400	57,900	75,900	94,600	112,600	131,100
~240		20,000	39,400	57,900	75,900	94,600	112,600	131,100
~260		20,000	39,400	57,900	75,900	94,600	112,600	131,100
~280		23,600	47,100	68,700	91,000	112,600	134,700	157,000
約1.5倍ヒダ		~88	~200	~300	~400	~500		

※片開きはW270cmまで

H	W	~67 1巾(片開き)	~150 2巾	~225 3巾	~300 4巾	~375 5巾	~450 6巾	~525 7巾	~600 8巾
~100		11,700	22,700	32,400	42,600	52,400	62,100	72,400	82,100
~120		11,700	22,700	32,400	42,600	52,400	62,100	72,400	82,100
~140		11,700	22,700	32,400	42,600	52,400	62,100	72,400	82,100
~160		14,900	29,200	42,600	55,600	68,600	82,100	95,100	108,500
~180		14,900	29,200	42,600	55,600	68,600	82,100	95,100	108,500
~200		14,900	29,200	42,600	55,600	68,600	82,100	95,100	108,500
~220		18,200	35,700	52,400	68,600	85,400	101,600	118,200	134,400
~240		18,200	35,700	52,400	68,600	85,400	101,600	118,200	134,400
~260		18,200	35,700	52,400	68,600	85,400	101,600	118,200	134,400
~280		21,400	42,600	62,100	82,100	101,600	121,500	141,500	161,000
約1.5倍ヒダ		~88	~200	~300	~400	~500	~600	~700	~800
フラット前ヒダ		~130	~260	~410	~560				

H	W	~67 1巾(片開き)	~150 2巾	~225 3巾	~300 4巾	~375 5巾	~450 6巾	~525 7巾	~600 8巾
~100		14,000	27,200	39,100	51,500	63,400	75,300	87,900	99,800
~120		14,000	27,200	39,100	51,500	63,400	75,300	87,900	99,800
~140		14,000	27,200	39,100	51,500	63,400	75,300	87,900	99,800
~160		18,000	35,100	51,500	67,400	83,200	99,800	115,600	132,000
~180		18,000	35,100	51,500	67,400	83,200	99,800	115,600	132,000
~200		18,000	35,100	51,500	67,400	83,200	99,800	115,600	132,000
~220		21,900	43,000	63,400	83,200	103,800	123,600	143,900	163,700
~240		21,900	43,000	63,400	83,200	103,800	123,600	143,900	163,700
~260		21,900	43,000	63,400	83,200	103,800	123,600	143,900	163,700

※片開きはW300cmまで

		コード式				ドラム式								
H	W	30~45	~90	~140	~190	~240	30~45	~90	~140	~190	~240	~290	~340	~390
50~100		14,200	18,200	22,800	30,500	35,100	17,200	21,200	25,800	33,500	38,100	45,400	53,900	58,700
~140		16,900	21,000	25,800	35,300	40,300	19,900	24,000	28,800	38,300	43,300	50,800	61,300	66,200
~180		19,700	23,800	28,800	40,200	45,300	22,700	26,800	31,800	43,200	48,300	56,000	68,800	73,800
~220		20,500	24,700	29,900	41,400	46,800	23,500	27,700	32,900	44,400	49,800	57,700	70,600	75,700
~260		23,200	27,500	32,900	46,300	51,800	26,200	30,500	35,900	49,300	54,800	62,900	78,000	83,000
~300		26,000	30,300	36,000	51,500	57,200	29,000	33,300	39,000	54,500	60,200	68,600	85,100	90,500

※ドラム式: 仕上り巾39cm以下の場合、仕上り丈は200cmまでとなります。

		コード式
H	W	18~30
50~100		18,800
~140		22,000
~180		24,700
~220		26,200
~240		29,000

		コード式				ドラム式								
H	W	30~45	~90	~140	~190	~240	30~45	~90	~140	~190	~240	~290	~340	~390
50~100		16,900	23,200	29,800	40,300	46,700	19,900	26,200	32,800	43,300	49,700	57,900	68,300	74,900
~140		19,900	26,600	33,700	46,600	53,600	22,900	29,600	36,700	49,600	56,600	65,100	77,900	84,700
~180		22,900	30,000	37,600	52,900	60,500	25,900	33,000	40,600	55,900	63,500	72,400	88,000	95,300
~220		24,000	31,500	39,500	55,300	63,500	27,000	34,500	42,500	58,300	66,500	75,700	91,500	99,100
~260		27,000	35,200	43,800	62,200	71,000	30,000	38,200	46,800	65,200	74,000	83,800	102,000	110,100
~300		30,200	38,900	48,100	69,400	78,900	33,200	41,900	51,100	72,400	81,900	92,200	112,500	121,100

※ドラム式: 仕上り巾39cm以下の場合、仕上り丈は200cmまでとなります。

		38mm (片開き/タッセルなし)					
H	W	~72	~100	~127	~155	~183	
~100		16,200	25,700	29,900	32,000	41,400	
~140		16,200	25,700	29,900	32,000	41,400	
~180		18,700	30,600	34,800	36,900	49,100	
~220		21,100	35,500	39,700	41,800	56,500	
~260		21,100	35,500	39,700	41,800	56,500	
~300		23,600	40,700	44,900	47,000	63,800	
26mm		-2,800	-2,100	-4,900	-4,200	-4,900	
18mm		-4,900	-5,600	-9,100	-9,800	-10,500	

※生地を伸ばした状態のサイズでご発注ください。

		スプリング・チェーンタイプ				
H	W	30~60	~80	~100	~120	~140
50~80		29,600	32,100	34,100	35,300	37,000
~120		32,400	35,500	37,500	38,600	40,500
~160		35,200	39,000	41,000	42,200	43,500
~200		37,400	40,400	42,600	43,800	45,100
~240			43,800	46,100	47,300	48,700

※丈は巾の3倍までが限度です。
※ロールソフト加工品は非防災品になります。

		ストレートバランス				
H	W	~100	~150	~200	~250	~300
~40		10,900	17,000	21,400	25,800	31,900

※マジックテープ仕様・裏面スポンジ付の価格になります。

H	W	~100	~150	~200	~250	~300
~40		11,300	16,300	21,300	27,200	28,700

※マジックテープ仕様の価格になります。

ナチュラル

TM-54051・54052



巾 ◇ 150cm 価 格 ◇ 4,400円/m リポート ◇ タテ 60.5cm ヨコ 75.0cm 取扱表示 ◇ リ-30 40 防炎性能 ◇ (イ) 乾燥機対応 熨め対応 ロールソフト
 組 成 ◇ ポリエステル100% 寸法変化率 ◇ 水洗い/タテ -0.5% ヨコ -0.2% ドライ/タテ -0.7% ヨコ 0.0% Made in Japan

標準仕様 形態安定加工価格表 約2倍ヒダ (タッセル含む)

H	W	~67 1巾(片開き)	~150 2巾	~225 3巾	~300 4巾	~375 5巾	~450 6巾	~525 7巾
~100		13,900	27,100	38,800	50,500	62,200	73,900	85,600
~120		13,900	27,100	38,800	50,500	62,200	73,900	85,600
~140		13,900	27,100	38,800	50,500	62,200	73,900	85,600
~160		17,800	34,900	50,500	66,100	81,700	97,900	113,500
~180		17,800	34,900	50,500	66,100	81,700	97,900	113,500
~200		17,800	34,900	50,500	66,100	81,700	97,900	113,500
~220		21,700	42,700	62,200	81,700	101,800	121,300	140,800
~240		21,700	42,700	62,200	81,700	101,800	121,300	140,800
~260		21,700	42,700	62,200	81,700	101,800	121,300	140,800
~280		25,600	50,500	73,900	97,900	121,300	144,700	168,800
約1.5倍ヒダ		~88	~200	~300	~400	~500		

※片開きはW270cmまで

プライム縫製仕様価格表 約2倍ヒダ (タッセル含む)

H	W	~67 1巾(片開き)	~150 2巾	~225 3巾	~300 4巾	~375 5巾	~450 6巾	~525 7巾
~100		14,500	28,200	40,500	52,700	65,000	77,200	89,400
~120		14,500	28,200	40,500	52,700	65,000	77,200	89,400
~140		14,500	28,200	40,500	52,700	65,000	77,200	89,400
~160		18,600	36,400	52,700	69,000	85,400	102,300	118,600
~180		18,600	36,400	52,700	69,000	85,400	102,300	118,600
~200		18,600	36,400	52,700	69,000	85,400	102,300	118,600
~220		22,700	44,600	65,000	85,400	106,400	126,800	147,200
~240		22,700	44,600	65,000	85,400	106,400	126,800	147,200
~260		22,700	44,600	65,000	85,400	106,400	126,800	147,200
~280		26,800	52,700	77,200	102,300	126,800	151,200	176,500
約1.5倍ヒダ		~88	~200	~300	~400	~500		

※片開きはW270cmまで

レギュラー縫製仕様価格表 約2倍ヒダ (タッセル含む)

H	W	~67 1巾(片開き)	~150 2巾	~225 3巾	~300 4巾	~375 5巾	~450 6巾	~525 7巾	~600 8巾
~100		13,400	26,000	37,200	48,300	59,500	70,600	81,800	93,500
~120		13,400	26,000	37,200	48,300	59,500	70,600	81,800	93,500
~140		13,400	26,000	37,200	48,300	59,500	70,600	81,800	93,500
~160		17,100	33,400	48,300	63,200	78,100	93,500	108,400	123,300
~180		17,100	33,400	48,300	63,200	78,100	93,500	108,400	123,300
~200		17,100	33,400	48,300	63,200	78,100	93,500	108,400	123,300
~220		20,800	40,900	59,500	78,100	97,200	115,800	134,400	153,000
~240		20,800	40,900	59,500	78,100	97,200	115,800	134,400	153,000
~260		20,800	40,900	59,500	78,100	97,200	115,800	134,400	153,000
~280		24,500	48,300	70,600	93,500	115,800	138,200	161,200	183,500
約1.5倍ヒダ		~88	~200	~300	~400	~500	~600	~700	~800
フラット前1倍ヒダ		~130	~260	~410	~560				

形状記憶加工価格表 約2倍ヒダ (タッセル含む)

H	W	~67 1巾(片開き)	~150 2巾	~225 3巾	~300 4巾	~375 5巾	~450 6巾	~525 7巾	~600 8巾
~100		15,700	30,500	43,800	57,100	70,400	83,800	97,100	111,000
~120		15,700	30,500	43,800	57,100	70,400	83,800	97,100	111,000
~140		15,700	30,500	43,800	57,100	70,400	83,800	97,100	111,000
~160		20,100	39,400	57,100	74,900	92,600	111,000	128,800	146,600
~180		20,100	39,400	57,100	74,900	92,600	111,000	128,800	146,600
~200		20,100	39,400	57,100	74,900	92,600	111,000	128,800	146,600
~220		24,600	48,200	70,400	92,600	115,500	137,700	159,900	182,100
~240		24,600	48,200	70,400	92,600	115,500	137,700	159,900	182,100
~260		24,600	48,200	70,400	92,600	115,500	137,700	159,900	182,100
~280		28,600	56,200	80,400	104,600	129,000	153,400	177,800	202,200
約1.5倍ヒダ		~88	~200	~300	~400	~500	~600	~700	~800

※片開きはW300cmまで

style no.60 プレーンシェード

H	W	コード式				ドラム式								
		30~45	~90	~140	~240	30~45	~90	~140	~190	~240	~290	~340	~390	
50~100		15,100	19,100	23,700	32,200	36,800	18,100	22,100	26,700	35,200	39,800	47,100	56,400	61,200
~140		18,300	22,300	27,100	37,800	42,800	21,300	25,300	30,100	40,800	45,800	53,400	65,100	70,000
~180		21,400	25,500	30,500	43,500	48,600	24,400	28,500	33,500	46,500	51,600	59,400	73,500	78,500
~220		22,300	26,500	31,700	44,700	50,100	25,300	29,500	34,700	47,700	53,100	61,100	75,300	80,400
~260		25,400	29,600	35,100	50,400	55,900	28,400	32,600	38,100	53,400	58,900	67,100	83,900	88,900
~300		28,600	32,900	38,500	56,100	61,900	31,600	35,900	41,500	59,100	64,900	73,400	92,300	97,700

※ドラム式: 仕上り巾39cm以下の場合、仕上り丈は200cmまでとなります。

スリムシェード

H	W	コード式
50~100		18~30
~140		19,600
~180		23,200
~220		26,300
~240		27,800
~260		31,000

style no.63 シャープシェード

H	W	コード式				ドラム式								
		30~45	~90	~140	~240	30~45	~90	~140	~190	~240	~290	~340	~390	
50~100		17,900	24,200	30,800	42,100	48,500	20,900	27,200	33,800	45,100	51,500	59,700	71,000	77,600
~140		21,300	28,000	35,100	49,300	56,200	24,300	31,000	38,100	52,300	59,200	67,800	81,800	88,700
~180		24,700	31,800	39,400	56,500	64,000	27,700	34,800	42,400	59,500	67,000	75,900	92,900	100,200
~220		25,800	33,300	41,300	58,900	67,000	28,800	36,300	44,300	61,900	70,000	79,300	96,400	104,100
~260		29,300	37,400	46,100	66,600	75,400	32,300	40,400	49,100	69,600	78,400	88,200	108,200	116,400
~300		32,900	41,600	50,800	74,300	83,900	35,900	44,600	53,800	77,300	86,900	97,100	120,000	128,700

※ドラム式: 仕上り巾39cm以下の場合、仕上り丈は200cmまでとなります。

ハトメカーテン 約1.8倍ヒダ

H	W	(片開き/タッセルなし)				
38mm		~72	~100	~127	~155	~183
~100		17,500	28,100	32,300	34,400	44,900
~140		17,500	28,100	32,300	34,400	44,900
~180		20,300	33,700	37,900	40,000	53,400
~220		23,100	39,400	43,600	45,700	61,900
~260		23,100	39,400	43,600	45,700	61,900
~300		26,000	45,000	49,200	51,300	70,400
26mm		-2,800	-2,100	-4,900	-4,200	-4,900
18mm		-4,900	-5,600	-9,100	-9,800	-10,500

※生地を伸ばした状態のサイズでご発注ください。

style no.S01 ロールソフト

スプリング・チェーンタイプ						
H	W	30~60	~80	~100	~120	~140
50~80		30,400	32,900	34,900	36,100	37,800
~120		33,600	36,700	38,700	39,800	41,700
~160		36,800	40,600	42,600	43,800	45,100
~200		39,000	42,000	44,200	45,400	46,700
~240			45,800	48,100	49,300	50,700

※丈は巾の3倍までが限度です。
 ※ロールソフト加工品は非防炎品になります。

バランス

ストレートバランス						
H	W	~100	~150	~200	~250	~300
~40		11,000	17,800	22,200	26,600	33,100
※マジックテープ仕様・裏面スポンジ付の価格になります。						
三ツ山・箱ヒダバランス (約2.5倍ヒダ)						
H	W	~100	~150	~200	~250	~300
~40		12,900	18,700	24,400	31,100	32,600
※マジックテープ仕様の価格になります。						

TM-54053



巾 ◇ 150cm 価格 ◇ 2,400円/m
組成 ◇ ポリエステル100%

リポート ◇ タテ 30.5cm ヨコ 25.0cm
寸法変化率 ◇ 水洗い/タテ -0.2% ヨコ 0.0%
ドライ/タテ -0.2% ヨコ -0.3%

取扱い表示 ◇ リ-30
防炎性能 ◇ (イ)
Made in Japan

H	W	~67 1巾(片開き)	~150 2巾	~225 3巾	~300 4巾	~375 5巾	~450 6巾	~525 7巾	~600 8巾
~100		6,800	13,100	19,400	25,700	32,400	38,700	45,000	51,300
~120		8,100	15,600	23,200	31,100	38,700	46,200	54,300	61,800
~140		8,100	15,600	23,200	31,100	38,700	46,200	54,300	61,800
~160		9,300	18,200	26,900	36,200	45,000	54,300	63,000	71,900
~180		10,600	20,700	31,100	41,200	51,300	61,800	71,900	82,400
~200		10,600	20,700	31,100	41,200	51,300	61,800	71,900	82,400
~220		11,800	23,200	35,000	46,200	58,000	69,400	81,200	92,400
~240		13,100	25,700	38,700	51,300	64,400	77,000	89,900	102,500
~260		13,100	25,700	38,700	51,300	64,400	77,000	89,900	102,500
~280		14,300	28,600	42,500	56,800	70,600	84,900	98,800	113,100
約1.5倍ヒダ		~88	~200	~300	~400	~500	~600	~700	~800
フラット前ヒダ		~130	~260	~410	~560				

H	W	~67 1巾(片開き)	~150 2巾	~225 3巾	~300 4巾	~375 5巾	~450 6巾	~525 7巾
~100		7,200	14,100	20,700	27,600	34,800	41,400	48,300
~120		8,700	16,800	24,900	33,300	41,400	49,500	58,200
~140		8,700	16,800	24,900	33,300	41,400	49,500	58,200
~160		9,900	19,500	28,800	38,700	48,300	58,200	67,500
~180		11,400	22,200	33,300	44,100	54,900	66,300	77,100
~200		11,400	22,200	33,300	44,100	54,900	66,300	77,100
~220		12,600	24,900	37,500	49,500	62,100	74,400	87,000
~240		14,100	27,600	41,400	54,900	69,000	82,500	96,300
~260		14,100	27,600	41,400	54,900	69,000	82,500	96,300
~280		15,300	30,600	45,600	60,900	75,600	90,900	105,900
約1.5倍ヒダ		~88	~200	~300	~400	~500		

H	W	~67 1巾(片開き)	~150 2巾	~225 3巾	~300 4巾	~375 5巾	~450 6巾	~525 7巾
~100		7,700	15,000	22,100	29,400	37,100	44,200	51,500
~120		9,200	17,900	26,500	35,600	44,200	52,800	62,000
~140		9,200	17,900	26,500	35,600	44,200	52,800	62,000
~160		10,600	20,800	30,800	41,300	51,500	62,000	72,000
~180		12,100	23,600	35,600	47,100	58,600	70,700	82,200
~200		12,100	23,600	35,600	47,100	58,600	70,700	82,200
~220		13,500	26,500	40,000	52,800	66,300	79,300	92,800
~240		15,000	29,400	44,200	58,600	73,600	88,000	102,800
~260		15,000	29,400	44,200	58,600	73,600	88,000	102,800
~280		16,400	32,700	48,600	64,900	80,700	97,000	112,900
約1.5倍ヒダ		~88	~200	~300	~400	~500		

H	W	~67 1巾(片開き)	~150 2巾	~225 3巾	~300 4巾	~375 5巾	~450 6巾	~525 7巾	~600 8巾
~100		8,700	16,900	24,900	33,100	41,700	49,700	57,900	65,900
~120		10,400	20,100	29,800	40,000	49,700	59,400	69,800	79,500
~140		10,400	20,100	29,800	40,000	49,700	59,400	69,800	79,500
~160		11,900	23,400	34,600	46,500	57,900	69,800	81,000	92,500
~180		13,600	26,600	40,000	53,000	65,900	79,500	92,500	105,900
~200		13,600	26,600	40,000	53,000	65,900	79,500	92,500	105,900
~220		15,200	29,800	45,000	59,400	74,600	89,200	104,400	118,800
~240		16,900	33,100	49,700	65,900	82,800	99,000	115,600	131,800
~260		16,900	33,100	49,700	65,900	82,800	99,000	115,600	131,800

コード式					ドラム式									
H	W	30~45	~90	~140	~190	~240	30~45	~90	~140	~190	~240	~290	~340	~390
50~100		12,800	16,900	21,400	28,000	32,600	15,800	19,900	24,400	31,000	35,600	42,800	50,100	54,900
~140		14,900	19,100	23,800	31,600	36,500	17,900	22,100	26,800	34,600	39,500	47,000	55,600	60,500
~180		16,400	20,600	25,600	34,000	39,200	19,400	23,600	28,600	37,000	42,200	49,700	59,100	64,100
~220		17,900	22,200	27,400	36,500	41,800	20,900	25,200	30,400	39,500	44,800	52,600	62,900	68,100
~260		20,000	24,300	29,700	40,100	45,700	23,000	27,300	32,700	43,100	48,700	56,600	68,500	73,500
~300		21,500	25,900	31,500	42,800	48,600	24,500	28,900	34,500	45,000	51,600	59,800	71,900	77,300

コード式	
H	W
50~100	18~30
~140	17,500
~180	20,200
~220	21,800
~240	23,800
~240	25,400

コード式					ドラム式									
H	W	30~45	~90	~140	~190	~240	30~45	~90	~140	~190	~240	~290	~340	~390
50~100		15,500	21,800	28,400	37,600	44,000	18,500	24,800	31,400	40,600	47,000	55,200	64,300	70,900
~140		17,900	24,600	31,700	42,600	49,600	20,900	27,600	34,700	45,600	52,600	61,100	71,900	78,800
~180		19,600	26,700	34,200	46,400	53,900	22,600	29,700	37,200	49,400	56,900	65,800	77,900	85,200
~220		21,300	28,800	36,800	50,000	58,200	24,300	31,800	39,800	53,000	61,200	70,400	83,500	91,200
~260		23,700	31,900	40,500	55,600	64,500	26,700	34,900	43,500	58,600	67,500	77,200	92,100	100,200
~300		25,600	34,200	43,500	60,100	69,600	28,600	37,200	46,500	63,100	72,600	82,900	98,700	107,300

コード式					ドラム式									
スワッグ数	1S	2S	4S	5S	1S	2S	3S	4S	5S	6S	7S	8S		
H	W	36~50	~100	~150	~200	~250	40~50	~100	~150	~200	~250	~300	~350	~400
100~140		20,800	32,400	44,900	57,700	71,900	23,800	35,400	47,900	60,700	74,900	85,800	100,100	114,500
~180		23,400	36,400	50,300	64,600	80,600	26,400	39,400	53,300	67,600	83,600	95,500	111,700	127,700
~220		26,000	40,300	56,000	71,500	89,200	29,000	43,300	59,000	74,500	92,200	105,100	123,100	140,800
~260		28,400	45,400	63,100	80,600	101,000	31,400	48,400	66,100	83,600	104,000	117,800	137,900	154,200
~300		31,800	49,600	68,600	87,700	109,600	34,800	52,600	71,600	90,700	112,600	127,400	149,500	171,300

スプリング・チェーンタイプ						
H	W	30~60	~80	~100	~120	~140
50~80		28,300	30,800	32,800	34,000	35,700
~120		30,600	33,700	35,700	36,800	38,700
~160		32,300	36,100	38,100	39,300	40,600
~200		35,000	38,000	40,200	41,400	42,700
~240			40,800	43,100	44,300	45,700

※丈は巾の3倍までが限度です。
※ロールソフト加工品は非防炎品になります。

TM-54056・54057

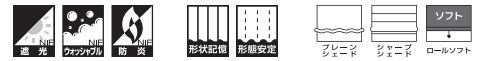

巾 ◇ 154cm 価格 ◇ 4,800円/m
組成 ◇ ポリエステル100%

リポート ◇ タテ 61.0cm ヨコ 75.0cm
寸法変化率 ◇ 水洗い/タテ 0.0% ヨコ 0.0%
ドライ/タテ -0.7% ヨコ -0.2%

取扱い表示 ◇ リ-30
防炎性能 ◇ (イ) あて布使用
Made in Japan

H	W	~68 1巾(片開き)	~154 2巾	~231 3巾	~308 4巾	~385 5巾	~462 6巾	~539 7巾
~100		14,800	28,900	41,500	54,600	67,200	79,600	92,900
~120		14,800	28,900	41,500	54,600	67,200	79,600	92,900
~140		14,800	28,900	41,500	54,600	67,200	79,600	92,900
~160		19,100	37,200	54,600	71,300	88,000	105,400	122,100
~180		19,100	37,200	54,600	71,300	88,000	105,400	122,100
~200		19,100	37,200	54,600	71,300	88,000	105,400	122,100
~220		23,200	45,600	67,200	88,000	109,600	130,500	152,100
~240		23,200	45,600	67,200	88,000	109,600	130,500	152,100
~260		23,200	45,600	67,200	88,000	109,600	130,500	152,100
~280		27,300	54,600	79,600	105,400	130,500	156,200	182,000
約1.5倍ヒダ		~89	~200	~308	~410	~513		

※片開きはW270cmまで

H	W	~68 1巾(片開き)	~154 2巾	~231 3巾	~308 4巾	~385 5巾	~462 6巾	~539 7巾
~100		15,400	30,000	43,200	56,900	70,000	83,000	96,900
~120		15,400	30,000	43,200	56,900	70,000	83,000	96,900
~140		15,400	30,000	43,200	56,900	70,000	83,000	96,900
~160		19,800	38,700	56,900	74,400	91,800	109,900	127,300
~180		19,800	38,700	56,900	74,400	91,800	109,900	127,300
~200		19,800	38,700	56,900	74,400	91,800	109,900	127,300
~220		24,200	47,500	70,000	91,800	114,400	136,100	158,700
~240		24,200	47,500	70,000	91,800	114,400	136,100	158,700
~260		24,200	47,500	70,000	91,800	114,400	136,100	158,700
~280		28,500	56,900	83,000	109,900	136,100	163,000	189,900
約1.5倍ヒダ		~89	~200	~308	~410	~513		

※片開きはW270cmまで

H	W	~68 1巾(片開き)	~154 2巾	~231 3巾	~308 4巾	~385 5巾	~462 6巾	~539 7巾	~616 8巾
~100		14,200	27,800	39,800	52,400	64,400	76,200	89,000	100,800
~120		14,200	27,800	39,800	52,400	64,400	76,200	89,000	100,800
~140		14,200	27,800	39,800	52,400	64,400	76,200	89,000	100,800
~160		18,300	35,700	52,400	68,300	84,300	100,800	116,800	133,500
~180		18,300	35,700	52,400	68,300	84,300	100,800	116,800	133,500
~200		18,300	35,700	52,400	68,300	84,300	100,800	116,800	133,500
~220		22,200	43,700	64,400	84,300	104,900	124,800	145,500	165,400
~240		22,200	43,700	64,400	84,300	104,900	124,800	145,500	165,400
~260		22,200	43,700	64,400	84,300	104,900	124,800	145,500	165,400
~280		26,200	52,400	76,200	100,800	124,800	149,400	174,000	197,900
約1.5倍ヒダ		~89	~200	~308	~410	~513	~616	~718	~821
フラット前ヒダ		~134	~268	~422	~576				

H	W	~68 1巾(片開き)	~154 2巾	~231 3巾	~308 4巾	~385 5巾	~462 6巾	~539 7巾
~100		16,500	32,300	46,600	61,500	75,700	89,800	104,900
~120		16,500	32,300	46,600	61,500	75,700	89,800	104,900
~140		16,500	32,300	46,600	61,500	75,700	89,800	104,900
~160		21,400	41,700	61,500	80,400	99,300	118,900	137,800
~180		21,400	41,700	61,500	80,400	99,300	118,900	137,800
~200		21,400	41,700	61,500	80,400	99,300	118,900	137,800
~220		26,100	51,200	75,700	99,300	123,800	147,400	171,900
~240		26,100	51,200	75,700	99,300	123,800	147,400	171,900
~260		26,100	51,200	75,700	99,300	123,800	147,400	171,900

※片開きはW300cmまで

		コード式				ドラム式								
H	W	30~45	~90	~140	~190	~240	30~45	~90	~140	~190	~240	~290	~340	~390
50~100		15,500	19,600	24,100	33,000	37,700	18,500	22,600	27,100	36,000	40,700	48,000	57,700	62,500
~140		18,900	23,000	27,700	39,100	44,000	21,900	26,000	30,700	42,100	47,000	54,600	67,000	71,900
~180		22,300	26,300	31,400	45,100	50,300	25,300	29,300	34,400	48,100	53,300	61,100	76,400	81,400
~220		23,200	27,300	32,500	46,400	51,700	26,200	30,300	35,500	49,400	54,700	62,800	78,200	83,300
~260		26,500	30,700	36,100	52,400	58,000	29,500	33,700	39,100	55,400	61,000	69,200	87,500	92,500
~300		29,900	34,200	39,800	58,900	64,700	32,900	37,200	42,800	61,900	67,700	76,300	96,500	101,800

※ドラム式: 仕上り巾39cm以下の場合、仕上り丈は200cmまでとなります。

		コード式	
H	W	18~30	
50~100		18~30	20,000
~140			23,800
~180			27,100
~220			28,600
~240			32,000

		コード式				ドラム式								
H	W	30~45	~90	~140	~190	~240	30~45	~90	~140	~190	~240	~290	~340	~390
50~100		18,300	24,600	31,200	43,000	49,400	21,300	27,600	34,200	46,000	52,400	60,600	72,300	78,900
~140		22,000	28,700	35,800	50,600	57,600	25,000	31,700	38,800	53,600	60,600	69,100	83,800	90,700
~180		25,600	32,700	40,300	58,200	65,800	28,600	35,700	43,300	61,200	68,800	77,700	96,000	103,300
~220		26,700	34,200	42,200	60,600	68,800	29,700	37,200	45,200	63,600	71,800	81,000	99,500	107,100
~260		30,400	38,600	47,200	68,800	77,600	33,400	41,600	50,200	71,800	80,600	90,400	111,900	120,100
~300		34,200	42,900	52,100	77,300	86,900	37,200	45,900	55,100	80,300	89,900	100,200	124,400	133,000

※ドラム式: 仕上り巾39cm以下の場合、仕上り丈は200cmまでとなります。

		38mm (片開き/タッセルなし)					
H	W	~72	~100	~127	~155	~183	
~100		18,100	29,300	33,500	35,600	46,900	
~140		18,100	29,300	33,500	35,600	46,900	
~180		21,200	35,400	39,600	41,700	56,500	
~220		24,200	41,500	45,700	47,800	65,600	
~260		24,200	41,500	45,700	47,800	65,600	
~300		27,200	48,100	52,300	54,400	74,700	
26mm		-2,800	-2,100	-4,900	-4,200	-4,900	
18mm		-4,900	-5,600	-9,100	-9,800	-10,500	

※生地を伸ばした状態のサイズでご発注ください。

		スプリング・チェーンタイプ					
H	W	30~60	~80	~100	~120	~140	~144
50-80		30,800	33,300	35,300	36,500	38,200	40,700
~120		34,200	37,300	39,300	40,400	42,300	44,800
~160		37,600	41,400	43,400	44,600	45,900	48,300
~200		39,800	42,800	45,000	46,200	47,500	50,100
~240			46,800	49,100	50,300	51,700	54,200

※丈は巾の3倍までが限度です。
※ロールソフト加工品は非防災品になります。

		ストレートバランス				
H	W	~100	~150	~200	~250	~300
~40		11,500	18,200	22,600	27,000	33,700

※マジックテープ仕様・裏面スポンジ付の価格になります。

		三つ山・箱ヒダバランス (約2.5倍ヒダ)				
H	W	~100	~150	~200	~250	~300
~40		13,700	19,900	26,000	28,500	34,600

※マジックテープ仕様の価格になります。

TM-54058



巾 ◇ 295 cm ヨコ使い 価格 ◇ 13,000 円/m リポート ◇ タテ 295.0 cm ヨコ 16.0 cm 取扱い表示 ◇ リ-30
 組成 ◇ ポリエステル100% 寸法変化率 ◇ 水洗い/タテ 0.0% ヨコ 0.0% 防炎性能 ◇ -
 ドライ/タテ 0.0% ヨコ 0.0% Made in Turkey あて布使用

縫製加工販売品 ※生地売りは対応していません。

標準仕様		レギュラー縫製仕様価格表 約2倍ヒダ (タッセルなし)							
W	H	~50 (片開き)	~100	~150	~200	~250	~300	~350	~400
~100		11,300	21,600	31,900	42,200	52,500	62,700	73,000	83,300
~120		11,600	22,000	32,500	43,000	53,400	63,800	74,200	84,700
~140		11,700	22,400	33,000	43,600	54,200	64,800	75,400	86,100
~160		11,900	22,700	33,500	44,300	55,100	65,800	76,600	87,400
~180		12,100	23,100	34,000	44,900	55,900	66,800	77,800	88,700
~200		12,300	23,400	34,500	45,600	56,700	67,900	78,900	90,100
~220		12,500	23,800	35,100	46,400	57,700	68,900	80,200	91,500
~240		12,700	24,100	35,600	47,000	58,500	70,000	81,400	92,900
~260		12,800	24,400	36,000	47,600	59,100	70,700	82,200	93,800
~275		12,800	24,400	36,000	47,600	59,100	70,700	82,200	93,800
約1.5倍ヒダ		~60	~120	~200	~266	~333	~400	~466	~533

※スタイル掛率適用となります。

エンブroidアリー

style no.30 (両開き/タッセル含む)

H \ W	~100	~150	~200	~250	~300	~350
~275	31,700	47,500	63,300	79,100	94,800	110,600

TM-54059・54060

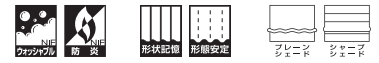

巾 ◇ 150cm 価格 ◇ 7,200円/m
組成 ◇ ポリエステル100%

リポート ◇ タテ 33.0cm ヨコ 25.0cm
寸法変化率 ◇ 水洗い/タテ 0.0% ヨコ 0.0%
ドライ/タテ 0.0% ヨコ 0.0%

取扱い表示 ◇ リ-30
防炎性能 ◇ (イ) あて布使用
Made in Japan

H	W	~67 1巾(片開き)	~150 2巾	~225 3巾	~300 4巾	~375 5巾	~450 6巾	~525 7巾
~100	18,000	34,900	50,600	65,500	81,400	96,300	112,000	
~120	18,000	34,900	50,600	65,500	81,400	96,300	112,000	
~140	20,700	41,300	59,900	78,500	96,300	114,900	133,500	
~160	20,700	41,300	59,900	78,500	96,300	114,900	133,500	
~180	24,400	47,900	69,200	90,700	112,000	133,500	154,800	
~200	27,300	53,500	78,500	102,700	126,900	152,100	176,200	
~220	27,300	53,500	78,500	102,700	126,900	152,100	176,200	
~240	30,000	59,900	87,800	114,900	142,800	170,700	197,600	
~260	30,000	59,900	87,800	114,900	142,800	170,700	197,600	
~280	32,800	65,500	96,300	126,900	157,600	188,300	219,000	
約1.5倍ヒダ	~88	~200	~300	~400	~500			

※片開きはW270cmまで

H	W	~67 1巾(片開き)	~150 2巾	~225 3巾	~300 4巾	~375 5巾	~450 6巾	~525 7巾
~100	18,500	35,900	52,100	67,500	83,900	99,200	115,500	
~120	18,500	35,900	52,100	67,500	83,900	99,200	115,500	
~140	21,300	42,500	61,700	80,900	99,200	118,400	137,600	
~160	21,300	42,500	61,700	80,900	99,200	118,400	137,600	
~180	25,100	49,300	71,300	93,500	115,500	137,600	159,600	
~200	28,100	55,100	80,900	105,900	130,800	156,800	181,800	
~220	28,100	55,100	80,900	105,900	130,800	156,800	181,800	
~240	30,900	61,700	90,500	118,400	147,200	176,000	203,800	
~260	30,900	61,700	90,500	118,400	147,200	176,000	203,800	
~280	33,800	67,500	99,200	130,800	162,600	194,200	226,000	
約1.5倍ヒダ	~88	~200	~300	~400	~500			

※片開きはW270cmまで

H	W	~67 1巾(片開き)	~150 2巾	~225 3巾	~300 4巾	~375 5巾	~450 6巾	~525 7巾	~600 8巾
~100	17,400	33,900	49,100	63,500	78,900	93,300	108,500	122,900	
~120	17,400	33,900	49,100	63,500	78,900	93,300	108,500	122,900	
~140	20,100	40,100	58,100	76,100	93,300	111,300	129,300	147,300	
~160	20,100	40,100	58,100	76,100	93,300	111,300	129,300	147,300	
~180	23,700	46,500	67,100	87,900	108,500	129,300	149,900	170,700	
~200	26,400	51,900	76,100	99,500	122,900	147,300	170,700	194,900	
~220	26,400	51,900	76,100	99,500	122,900	147,300	170,700	194,900	
~240	29,100	58,100	85,100	111,300	138,300	165,300	191,300	218,300	
~260	29,100	58,100	85,100	111,300	138,300	165,300	191,300	218,300	
~280	31,800	63,500	93,300	122,900	152,700	182,300	212,100	241,700	
約1.5倍ヒダ	~88	~200	~300	~400	~500	~600	~700	~800	
フラット前ヒダ	~130	~260	~410	~560					

H	W	~67 1巾(片開き)	~150 2巾	~225 3巾	~300 4巾	~375 5巾	~450 6巾	~525 7巾	~600 8巾
~100	19,500	37,900	55,100	71,400	88,900	105,200	122,400	138,800	
~120	19,500	37,900	55,100	71,400	88,900	105,200	122,400	138,800	
~140	22,500	44,900	65,300	85,700	105,200	125,600	146,000	166,400	
~160	22,500	44,900	65,300	85,700	105,200	125,600	146,000	166,400	
~180	26,600	52,200	75,500	99,100	122,400	146,000	169,400	192,900	
~200	29,700	58,300	85,700	112,200	138,800	166,400	192,900	220,400	
~220	29,700	58,300	85,700	112,200	138,800	166,400	192,900	220,400	
~240	32,700	65,300	95,900	125,600	156,200	186,800	216,300	246,900	
~260	32,700	65,300	95,900	125,600	156,200	186,800	216,300	246,900	

※片開きはW300cmまで

		コード式				ドラム式								
H	W	30~45	~90	~140	~190	~240	30~45	~90	~140	~190	~240	~290	~340	~390
50~100	18,900	22,900	27,400	39,200	43,900		21,900	25,900	30,400	42,200	46,900	54,400	67,200	72,000
~140	21,700	25,700	30,400	44,100	49,000		24,700	28,700	33,400	47,100	52,000	59,800	75,200	80,100
~180	24,400	28,400	33,400	49,600	54,700		27,400	31,400	36,400	52,600	57,700	65,600	83,000	88,000
~220	29,700	33,700	38,900	58,700	64,000		32,700	36,700	41,900	61,700	67,000	75,400	97,200	102,300
~260	32,400	36,500	41,900	64,100	69,700		35,400	39,500	44,900	67,100	72,700	81,200	105,200	110,200
~300	35,200	39,300	44,900	69,000	74,800		38,200	42,300	47,900	72,000	77,800	86,600	112,400	117,700

※ドラム式：仕上り巾39cm以下の場合、仕上り丈は200cmまでとなります。

		コード式				ドラム式								
H	W	30~45	~90	~140	~190	~240	30~45	~90	~140	~190	~240	~290	~340	~390
50~100	21,800	28,100	34,700	49,700	56,100		24,800	31,100	37,700	52,700	59,100	67,300	82,300	88,800
~140	24,800	31,500	38,600	56,000	63,000		27,800	34,500	41,600	59,000	66,000	74,500	92,500	99,300
~180	27,800	34,900	42,400	63,000	70,500		30,800	37,900	45,400	66,000	73,500	82,400	102,900	110,200
~220	33,400	40,900	48,900	73,800	81,900		36,400	43,900	51,900	76,800	84,900	94,200	119,400	127,000
~260	36,400	44,600	53,200	81,300	90,200		39,400	47,600	56,200	84,300	93,200	102,900	130,500	138,700
~300	39,600	48,300	57,500	88,100	97,700		42,600	51,300	60,500	91,100	100,700	111,000	141,000	149,700

※ドラム式：仕上り巾39cm以下の場合、仕上り丈は200cmまでとなります。

H	W	~67 1巾(片開き)	~150 2巾	~225 3巾	~300 4巾	~375 5巾	~450 6巾	~525 7巾
~100	24,100	47,100	68,900	89,900	111,900	132,900	154,700	
~120	25,000	48,900	71,500	93,400	116,200	138,100	160,800	
~140	28,600	57,000	83,400	109,900	135,500	161,900	188,400	
~160	29,400	58,700	86,000	113,300	139,800	167,100	194,400	
~180	34,000	67,100	98,000	129,000	159,900	191,000	221,800	
~200	37,800	74,400	109,900	144,500	179,100	214,800	249,300	
~220	38,700	76,200	112,500	148,000	183,500	220,000	255,400	
~240	42,200	84,300	124,400	163,700	203,700	243,800	282,900	
~260	43,100	86,000	127,000	167,100	208,100	249,000	289,000	
~280	46,800	93,400	138,100	182,600	227,200	271,900	316,500	
約1.5倍ヒダ	~88	~200	~300	~400	~500			

※片開きはW270cmまで

H	W	~67 1巾(片開き)	~150 2巾	~225 3巾	~300 4巾	~375 5巾	~450 6巾	~525 7巾
~100	25,100	49,000	71,700	93,600	116,500	138,300	161,100	
~120	26,000	50,800	74,500	97,300	121,100	143,900	167,600	
~140	29,700	59,300	86,900	114,400	141,100	168,700	196,200	
~160	30,600	61,100	89,600	118,100	145,700	174,200	202,700	
~180	35,400	69,800	102,000	134,500	166,700	199,000	231,300	
~200	39,300	77,500	114,400	150,600	186,600	223,800	260,000	
~220	40,200	79,300	117,200	154,300	191,300	229,400	266,500	
~240	44,000	87,800	129,600	170,500	212,300	254,200	295,000	
~260	44,900	89,600	132,400	174,200	217,000	259,700	301,500	
~280	48,700	97,300	143,900	190,400	237,000	283,500	330,200	
約1.5倍ヒダ	~88	~200	~300	~400	~500			

※片開きはW270cmまで

H	W	~67 1巾(片開き)	~150 2巾	~225 3巾	~300 4巾	~375 5巾	~450 6巾	~525 7巾	~600 8巾
~100	23,100	45,300	66,200	86,200	107,300	127,400	148,200	168,300	
~120	23,900	46,900	68,600	89,500	111,300	132,200	153,900	174,800	
~140	27,400	54,700	80,000	105,300	129,800	155,100	180,400	205,700	
~160	28,200	56,300	82,400	108,500	133,800	159,900	186,000	212,100	
~180	32,700	64,400	93,900	123,600	153,100	182,800	212,300	242,000	
~200	36,200	71,400	105,300	138,400	171,500	205,700	238,800	272,700	
~220	37,000	73,000	107,700	141,700	175,600	210,500	244,500	279,200	
~240	40,500	80,800	119,200	156,700	195,000	233,400	270,700	309,100	
~260	41,300	82,400	121,600	159,900	199,100	238,200	276,400	315,500	
~280	44,800	89,500	132,200	174,800	217,500	260,100	302,900	345,400	
約1.5倍ヒダ	~88	~200	~300	~400	~500	~600	~700	~800	

TM-54063・54064

巾 ◇ 100cm 価格 ◇ 9,500円/m
組成 ◇ ポリエステル100%

リポート ◇ タテ49.0cm ヨコ50.0cm
寸法変化率 ◇ 水洗い/タテ -0.3% ヨコ -0.2%
ドライ/タテ -0.5% ヨコ 0.3%



取扱い表示 ◇ リ-30
防炎性能 ◇ (イ) あて布使用
Made in Japan

H	W	~44 1巾(片開き)	~100 2巾	~150 3巾	~200 4巾	~250 5巾	~300 6巾	~350 7巾	~400 8巾
~100	18,900	37,700	54,100	69,400	85,700	102,100	117,300	133,700	150,100
~120	24,300	48,600	69,400	91,200	111,900	133,700	155,500	176,200	197,000
~140	24,300	48,600	69,400	91,200	111,900	133,700	155,500	176,200	197,000
~160	24,300	48,600	69,400	91,200	111,900	133,700	155,500	176,200	197,000
~180	29,800	58,500	85,700	111,900	139,100	165,300	192,500	218,700	245,000
~200	29,800	58,500	85,700	111,900	139,100	165,300	192,500	218,700	245,000
~220	35,200	69,400	102,100	133,700	165,300	198,000	229,600	262,300	295,000
~240	35,200	69,400	102,100	133,700	165,300	198,000	229,600	262,300	295,000
~260	40,700	80,300	117,300	155,500	192,500	229,600	267,700	304,800	342,000
~280	40,700	80,300	117,300	155,500	192,500	229,600	267,700	304,800	342,000
約1.5倍ヒダ	~56	~120	~200	~266	~333	~400	~466	~533	~600

※片開きはW270cmまで

H	W	~44 1巾(片開き)	~100 2巾	~150 3巾	~200 4巾	~250 5巾	~300 6巾	~350 7巾	~400 8巾
~100	19,200	38,300	55,000	70,500	87,200	103,800	119,400	136,000	152,600
~120	24,700	49,400	70,500	92,700	113,800	136,000	158,200	179,300	199,400
~140	24,700	49,400	70,500	92,700	113,800	136,000	158,200	179,300	199,400
~160	24,700	49,400	70,500	92,700	113,800	136,000	158,200	179,300	199,400
~180	30,300	59,400	87,200	113,800	141,600	168,200	196,000	222,600	249,000
~200	30,300	59,400	87,200	113,800	141,600	168,200	196,000	222,600	249,000
~220	35,800	70,500	103,800	136,000	168,200	201,500	233,700	267,000	300,300
~240	35,800	70,500	103,800	136,000	168,200	201,500	233,700	267,000	300,300
~260	41,400	81,600	119,400	158,200	196,000	233,700	272,600	310,300	349,000
~280	41,400	81,600	119,400	158,200	196,000	233,700	272,600	310,300	349,000
約1.5倍ヒダ	~56	~120	~200	~266	~333	~400	~466	~533	~600

※片開きはW270cmまで

H	W	~44 1巾(片開き)	~100 2巾	~150 3巾	~200 4巾	~250 5巾	~300 6巾	~350 7巾	~400 8巾
~100	18,600	37,100	53,200	68,200	84,200	100,300	115,300	131,300	147,300
~120	23,900	47,800	68,200	89,600	109,900	131,300	152,700	173,000	193,300
~140	23,900	47,800	68,200	89,600	109,900	131,300	152,700	173,000	193,300
~160	23,900	47,800	68,200	89,600	109,900	131,300	152,700	173,000	193,300
~180	29,300	57,500	84,200	109,900	136,700	162,300	189,100	214,800	240,500
~200	29,300	57,500	84,200	109,900	136,700	162,300	189,100	214,800	240,500
~220	34,600	68,200	100,300	131,300	162,300	194,400	225,500	257,600	288,700
~240	34,600	68,200	100,300	131,300	162,300	194,400	225,500	257,600	288,700
~260	40,000	78,900	115,300	152,700	189,100	225,500	262,900	299,300	335,700
~280	40,000	78,900	115,300	152,700	189,100	225,500	262,900	299,300	335,700
約1.5倍ヒダ	~56	~120	~200	~266	~333	~400	~466	~533	~600
フラット縫製	~80	~160	~260	~360	~460	~560			

H	W	~44 1巾(片開き)	~100 2巾	~150 3巾	~200 4巾	~250 5巾	~300 6巾	~350 7巾	~400 8巾
~100	19,800	39,500	56,800	72,900	90,100	107,400	123,500	140,700	156,800
~120	25,500	51,000	72,900	95,900	117,700	140,700	163,700	185,600	207,500
~140	25,500	51,000	72,900	95,900	117,700	140,700	163,700	185,600	207,500
~160	25,500	51,000	72,900	95,900	117,700	140,700	163,700	185,600	207,500
~180	31,300	61,400	90,100	117,700	146,500	174,100	202,800	230,400	258,000
~200	31,300	61,400	90,100	117,700	146,500	174,100	202,800	230,400	258,000
~220	37,000	72,900	107,400	140,700	174,100	208,600	241,900	276,400	310,900
~240	37,000	72,900	107,400	140,700	174,100	208,600	241,900	276,400	310,900
~260	42,800	84,400	123,500	163,700	202,800	241,900	282,200	321,300	360,400

※片開きはW300cmまで

		コード式				ドラム式								
H	W	~44	~90	~140	~190	~240	~300	~360	~420	~480	~540	~600		
50~100	~100	22,600	26,400	43,200	46,900	63,500	25,600	29,400	46,200	49,900	66,500	74,400	90,600	95,400
~140	~140	27,600	31,500	52,600	56,100	76,200	30,600	34,500	55,600	59,100	79,200	87,600	108,800	113,700
~180	~180	28,500	32,400	53,700	57,300	77,600	31,500	35,400	56,700	60,300	80,600	89,100	110,400	115,400
~220	~220	33,500	37,400	62,200	65,700	91,000	36,500	40,400	65,200	68,700	94,000	103,000	127,700	132,800
~260	~260	38,500	42,400	71,500	74,900	104,400	41,500	45,400	74,500	77,900	107,400	116,700	145,900	150,900
~300	~300	43,500	47,500	80,900	84,100	117,100	46,500	50,500	83,900	87,100	120,100	129,900	163,800	169,200

※ドラム式：仕上り巾39cm以下の場合、仕上り巾は200cmまでとなります。

		コード式				ドラム式								
H	W	~44	~90	~140	~190	~240	~300	~360	~420	~480	~540	~600		
50~100	~100	25,500	31,800	51,300	57,900	77,100	28,500	34,800	54,300	60,900	80,100	88,200	106,800	113,400
~140	~140	30,900	37,600	61,800	68,800	92,000	33,900	40,600	64,800	71,800	95,000	103,600	127,600	134,500
~180	~180	31,900	39,000	63,700	71,300	95,000	34,900	42,000	66,700	74,300	98,000	106,900	131,600	138,900
~220	~220	37,200	44,800	73,300	81,400	110,900	40,200	47,800	76,300	84,400	113,900	123,100	151,300	159,000
~260	~260	42,700	50,800	84,200	92,900	127,400	45,700	53,800	87,200	95,900	130,400	140,100	173,100	181,200
~300	~300	48,100	56,800	95,200	104,400	143,000	51,100	59,800	98,200	107,400	146,000	156,300	194,800	203,500

※ドラム式：仕上り巾39cm以下の場合、仕上り巾は200cmまでとなります。

H	W	~44 1巾(片開き)	~100 2巾	~150 3巾	~200 4巾	~250 5巾	~300 6巾	~350 7巾	~400 8巾
~100	25,000	49,900	66,300	87,700	110,100	126,500	147,800	170,300	192,800
~120	31,300	62,600	83,400	112,100	139,800	161,600	190,300	218,000	245,700
~140	32,200	64,300	85,100	114,700	143,300	165,100	194,700	223,200	251,700
~160	33,000	66,000	86,800	117,300	146,700	168,500	199,000	228,400	256,900
~180	39,400	77,700	104,900	140,700	177,400	203,600	240,400	276,200	312,000
~200	40,300	79,400	106,600	143,300	180,900	207,100	244,700	281,400	317,200
~220	46,600	92,100	124,800	167,700	210,600	243,300	286,200	330,200	374,200
~240	47,400	93,800	126,500	170,300	214,100	246,800	290,500	335,400	379,400
~260	53,800	106,400	143,400	194,700	244,700	281,800	333,000	383,100	430,700
~280	54,700	108,200	145,200	197,300	248,200	285,300	337,300	388,400	436,000
約1.5倍ヒダ	~56	~120	~200	~266	~333	~400	~466	~533	~600

※片開きはW270cmまで

H	W	~44 1巾(片開き)	~100 2巾	~150 3巾	~200 4巾	~250 5巾	~300 6巾	~350 7巾	~400 8巾
~100	25,800	51,400	68,100	90,100	113,300	129,900	152,000	175,100	197,200
~120	32,200	64,300	85,400	115,100	143,600	165,800	195,400	224,000	252,600
~140	33,100	66,200	87,300	117,900	147,300	169,500	200,100	229,600	258,200
~160	34,000	68,000	89,100	120,600	151,000	173,200	204,700	235,100	264,000
~180	40,600	79,900	107,700	144,500	182,600	209,200	247,200	284,000	320,800
~200	41,500	81,800	109,600	147,300	186,300	212,900	251,800	289,600	326,400
~220	47,900	94,700	128,000	172,300	216,600	249,900	294,200	339,600	375,000
~240	48,800	96,600	129,900	175,100	220,300	253,600	298,800	345,200	380,400
~260	55,400	109,500	147,300	200,100	251,800	289,500	342,400	394,000	447,800
~280	56,300	111,400	149,200	202,900	255,600	293,300	347,000	399,600	453,200
約1.5倍ヒダ	~56	~120	~200	~266	~333	~400	~466	~533	~600

※片開きはW270cmまで

H	W	~44 1巾(片開き)	~100 2巾	~150 3巾	~200 4巾	~250 5巾	~300 6巾	~350 7巾	~400 8巾
~100	24,300	48,500	64,6						

TM-54065



巾 ◇ 101 cm 価格 ◇ 6,600 円/m リポート ◇ タテ 39.5 cm ヨコ 33.6 cm 取扱表示 ◇ リ-30 40 1 2 3 4 5 6 7 8 9 10 11 12 13 14 15 16 17 18 19 20 21 22 23 24 25 26 27 28 29 30 31 32 33 34 35 36 37 38 39 40 41 42 43 44 45 46 47 48 49 50 51 52 53 54 55 56 57 58 59 60 61 62 63 64 65 66 67 68 69 70 71 72 73 74 75 76 77 78 79 80 81 82 83 84 85 86 87 88 89 90 91 92 93 94 95 96 97 98 99 100 101 102 103 104 105 106 107 108 109 110 111 112 113 114 115 116 117 118 119 120 121 122 123 124 125 126 127 128 129 130 131 132 133 134 135 136 137 138 139 140 141 142 143 144 145 146 147 148 149 150 151 152 153 154 155 156 157 158 159 160 161 162 163 164 165 166 167 168 169 170 171 172 173 174 175 176 177 178 179 180 181 182 183 184 185 186 187 188 189 190 191 192 193 194 195 196 197 198 199 200 201 202 203 204 205 206 207 208 209 210 211 212 213 214 215 216 217 218 219 220 221 222 223 224 225 226 227 228 229 230 231 232 233 234 235 236 237 238 239 240 241 242 243 244 245 246 247 248 249 250 251 252 253 254 255 256 257 258 259 260 261 262 263 264 265 266 267 268 269 270 271 272 273 274 275 276 277 278 279 280 281 282 283 284 285 286 287 288 289 290 291 292 293 294 295 296 297 298 299 300 301 302 303 304 305 306 307 308 309 310 311 312 313 314 315 316 317 318 319 320 321 322 323 324 325 326 327 328 329 330 331 332 333 334 335 336 337 338 339 340 341 342 343 344 345 346 347 348 349 350 351 352 353 354 355 356 357 358 359 360 361 362 363 364 365 366 367 368 369 370 371 372 373 374 375 376 377 378 379 380 381 382 383 384 385 386 387 388 389 390 391 392 393 394 395 396 397 398 399 400 401 402 403 404 405 406 407 408 409 410 411 412 413 414 415 416 417 418 419 420 421 422 423 424 425 426 427 428 429 430 431 432 433 434 435 436 437 438 439 440 441 442 443 444 445 446 447 448 449 450 451 452 453 454 455 456 457 458 459 460 461 462 463 464 465 466 467 468 469 470 471 472 473 474 475 476 477 478 479 480 481 482 483 484 485 486 487 488 489 490 491 492 493 494 495 496 497 498 499 500 501 502 503 504 505 506 507 508 509 510 511 512 513 514 515 516 517 518 519 520 521 522 523 524 525 526 527 528 529 530 531 532 533 534 535 536 537 538 539 540 541 542 543 544 545 546 547 548 549 550 551 552 553 554 555 556 557 558 559 560 561 562 563 564 565 566 567 568 569 570 571 572 573 574 575 576 577 578 579 580 581 582 583 584 585 586 587 588 589 590 591 592 593 594 595 596 597 598 599 600 601 602 603 604 605 606 607 608 609 610 611 612 613 614 615 616 617 618 619 620 621 622 623 624 625 626 627 628 629 630 631 632 633 634 635 636 637 638 639 640 641 642 643 644 645 646

TM-54072・54073



巾 ◇ 100cm 価格 ◇ 6,700円/m リポート ◇ タテ43.0cm ヨコ33.1cm 取扱表示 ◇ リ-30 防炎性能 ◇ (イ) 炎び布使用
 組成 ◇ ポリエステル100% 寸法変化率 ◇ 水洗い/タテ -0.3% ヨコ -0.3% ドライ/タテ 0.0% ヨコ 0.0% Made in Japan

H	W	~44 1巾(片開き)	~100 2巾	~150 3巾	~200 4巾	~250 5巾	~300 6巾	~350 7巾	~400 8巾
~100	16,600	32,300	46,000	59,800	73,600	88,200	101,900	115,700	
~120	16,600	32,300	46,000	59,800	73,600	88,200	101,900	115,700	
~140	19,800	38,800	56,600	73,600	91,400	108,400	126,200	143,200	
~160	19,800	38,800	56,600	73,600	91,400	108,400	126,200	143,200	
~180	23,000	46,000	67,100	88,200	108,400	129,500	150,500	171,600	
~200	23,000	46,000	67,100	88,200	108,400	129,500	150,500	171,600	
~220	23,000	46,000	67,100	88,200	108,400	129,500	150,500	171,600	
~240	27,100	53,300	77,600	101,900	126,200	150,500	174,800	199,100	
~260	27,100	53,300	77,600	101,900	126,200	150,500	174,800	199,100	
~280	30,300	59,800	88,200	115,700	143,200	171,600	199,100	227,500	
約1.5倍ヒダ	~56	~120	~200	~266	~333	~400	~466	~533	

※片開きはW270cmまで

H	W	~44 1巾(片開き)	~100 2巾	~150 3巾	~200 4巾	~250 5巾	~300 6巾	~350 7巾	~400 8巾
~100	16,900	33,000	47,100	61,200	75,300	90,200	104,400	118,500	
~120	16,900	33,000	47,100	61,200	75,300	90,200	104,400	118,500	
~140	20,200	39,600	57,900	75,300	93,600	111,000	129,300	146,700	
~160	20,200	39,600	57,900	75,300	93,600	111,000	129,300	146,700	
~180	23,600	47,100	68,700	90,200	111,000	132,600	154,200	175,700	
~200	23,600	47,100	68,700	90,200	111,000	132,600	154,200	175,700	
~220	23,600	47,100	68,700	90,200	111,000	132,600	154,200	175,700	
~240	27,700	54,600	79,500	104,400	129,300	154,200	179,100	204,000	
~260	27,700	54,600	79,500	104,400	129,300	154,200	179,100	204,000	
~280	31,000	61,200	90,200	118,500	146,700	175,700	204,000	233,000	
約1.5倍ヒダ	~56	~120	~200	~266	~333	~400	~466	~533	

※片開きはW270cmまで

H	W	~44 1巾(片開き)	~100 2巾	~150 3巾	~200 4巾	~250 5巾	~300 6巾	~350 7巾	~400 8巾
~100	16,200	31,600	45,000	58,400	71,900	86,100	99,500	112,900	
~120	16,200	31,600	45,000	58,400	71,900	86,100	99,500	112,900	
~140	19,400	37,900	55,300	71,900	89,200	105,800	123,200	139,800	
~160	19,400	37,900	55,300	71,900	89,200	105,800	123,200	139,800	
~180	22,500	45,000	65,500	86,100	105,800	126,400	146,900	167,500	
~200	22,500	45,000	65,500	86,100	105,800	126,400	146,900	167,500	
~220	22,500	45,000	65,500	86,100	105,800	126,400	146,900	167,500	
~240	26,500	52,100	75,800	99,500	123,200	146,900	170,600	194,300	
~260	26,500	52,100	75,800	99,500	123,200	146,900	170,600	194,300	
~280	29,600	58,400	86,100	112,900	139,800	167,500	194,300	222,000	
約1.5倍ヒダ	~56	~120	~200	~266	~333	~400	~466	~533	
フラット約1倍ヒダ	~80	~160	~260	~360	~460	~560			

H	W	~44 1巾(片開き)	~100 2巾	~150 3巾	~200 4巾	~250 5巾	~300 6巾	~350 7巾	~400 8巾
~100	17,600	34,400	49,200	64,000	78,700	94,400	109,200	124,000	
~120	17,600	34,400	49,200	64,000	78,700	94,400	109,200	124,000	
~140	21,100	41,300	60,500	78,700	97,900	116,200	135,300	153,600	
~160	21,100	41,300	60,500	78,700	97,900	116,200	135,300	153,600	
~180	24,600	49,200	71,800	94,400	116,200	138,800	161,400	184,000	
~200	24,600	49,200	71,800	94,400	116,200	138,800	161,400	184,000	
~220	24,600	49,200	71,800	94,400	116,200	138,800	161,400	184,000	
~240	29,000	57,000	83,100	109,200	135,300	161,400	187,500	213,600	
~260	29,000	57,000	83,100	109,200	135,300	161,400	187,500	213,600	

※片開きはW300cmまで

H	W	コード式				ドラム式							
		30~45	~90	~140	~190	30~45	~90	~140	~190	~240	~290	~340	~390
50~100	17,700	21,700	33,700	37,500	49,500	20,700	24,700	36,700	40,500	52,500	60,100	72,400	77,200
~140	21,500	25,500	40,100	43,800	58,400	24,500	28,500	43,100	46,800	61,400	69,300	84,000	88,900
~180	24,700	28,700	45,800	49,600	67,100	27,700	31,700	48,800	52,600	70,100	78,300	95,400	100,400
~220	28,000	32,000	52,200	55,900	75,900	31,000	35,000	55,200	59,000	78,900	87,500	107,600	112,700
~260	31,700	35,800	58,500	62,200	84,600	34,700	38,800	61,500	65,200	87,600	96,500	119,200	124,200
~300	34,900	39,000	64,300	67,900	93,400	37,900	42,000	67,300	70,900	96,400	105,700	130,600	136,000

※ドラム式:仕上り巾39cm以下の場合、仕上り巾は200cmまでとなります。

H	W	コード式				ドラム式							
		30~45	~90	~140	~190	30~45	~90	~140	~190	~240	~290	~340	~390
50~100	20,600	26,800	41,300	47,900	62,100	23,600	29,800	44,300	50,900	65,100	73,300	87,700	94,300
~140	24,600	31,300	48,700	55,700	73,000	27,600	34,300	51,700	58,700	76,000	84,500	101,700	108,500
~180	28,100	35,200	55,400	63,000	83,800	31,100	38,200	58,400	66,000	86,800	95,700	115,900	123,200
~220	31,500	39,100	62,800	70,800	94,600	34,500	42,100	65,800	73,800	97,600	106,900	130,200	137,900
~260	35,700	43,900	70,600	79,200	106,100	38,700	46,900	73,600	82,200	109,100	118,900	145,200	153,300
~300	39,300	48,000	77,800	87,000	117,700	42,300	51,000	80,800	90,000	120,700	130,900	160,100	168,700

※ドラム式:仕上り巾39cm以下の場合、仕上り巾は200cmまでとなります。

H	W	~44 1巾(片開き)	~100 2巾	~150 3巾	~200 4巾	~250 5巾	~300 6巾	~350 7巾	~400 8巾
~100	22,700	44,500	58,200	78,100	98,000	112,600	132,400	152,300	
~120	23,600	46,300	60,000	80,700	101,500	116,100	136,700	157,500	
~140	27,700	54,500	72,300	97,100	122,800	139,800	165,400	190,200	
~160	28,500	56,200	74,000	99,700	126,200	143,200	169,700	195,400	
~180	32,600	65,200	86,300	117,000	146,700	167,800	198,400	229,100	
~200	33,500	66,900	88,000	119,600	150,200	171,300	202,700	234,300	
~220	34,400	68,700	89,800	122,200	153,700	174,800	207,100	239,500	
~240	39,300	77,700	102,000	138,500	175,000	199,300	235,700	272,200	
~260	40,200	79,400	103,700	141,100	178,400	202,700	240,100	277,400	
~280	44,300	87,700	116,100	157,500	198,900	227,300	268,700	311,100	
約1.5倍ヒダ	~56	~120	~200	~266	~333	~400	~466	~533	

※片開きはW270cmまで

H	W	~44 1巾(片開き)	~100 2巾	~150 3巾	~200 4巾	~250 5巾	~300 6巾	~350 7巾	~400 8巾
~100	23,500	46,100	60,200	80,800	101,400	116,300	137,000	157,600	
~120	24,400	47,900	62,000	83,600	105,100	120,000	141,600	163,200	
~140	28,600	56,400	74,700	100,500	127,100	144,500	171,200	197,000	
~160	29,500	58,200	76,500	103,200	130,800	148,200	175,800	202,500	
~180	33,900	67,600	89,200	120,900	152,000	173,600	205,400	237,100	
~200	34,800	69,500	91,100	123,700	155,700	177,300	210,000	242,700	
~220	35,700	71,300	92,900	126,500	159,400	181,000	214,700	248,300	
~240	40,800	80,700	105,600	143,500	181,400	206,300	244,200	282,200	
~260	41,700	82,500	107,400	146,300	185,100	210,000	248,900	287,700	
~280	45,900	91,000	120,000	163,200	206,300	235,300	278,400	322,300	
約1.5倍ヒダ	~56	~120	~200	~266	~333	~400	~466	~533	

※片開きはW270cmまで

H	W	~44 1巾(片開き)	~100 2巾	~150 3巾	~200 4巾	~250 5巾	~300 6巾	~350 7巾	~400 8巾
~100	21,900	43,000	56,400	75,500	94,600	108,800	127,900	147,000	
~120	22,700	44,600	58,000	77,900	97,900	112,100	131,900	151,800	
~140	26,700	52,500	69,900	93,800	118,400	135,000	159,700	183,600	
~160	27,500	54,100	71,500	96,200	121,600	138,200	163,700	188,400	
~180	31,500	62,900	83,400	112,900	141,500	162,100	191,500	221,000	
~200	32,300	64,500	85,000	115,300	144,700	165,300	195,500	225,900	
~220	33,100	66,100	86,600	117,700	148,000	168,600	199,600		

TM-54074・54075



巾 ◇ 150cm 価格 ◇ 4,300円/m
組成 ◇ ポリエステル100%

リポート ◇ タテ 34.0cm ヨコ 25.0cm
寸法変化率 ◇ 水洗い/タテ -0.3% ヨコ -0.2%
ドライ/タテ 0.0% ヨコ -0.2%

取扱い表示 ◇ リ-30
防炎性能 ◇ (イ) あて布使用
Made in Japan

H	W	~67 1巾(片開き)	~150 2巾	~225 3巾	~300 4巾	~375 5巾	~450 6巾	~525 7巾
~100		12,500	24,700	35,700	46,500	57,400	68,200	79,200
~120		12,500	24,700	35,700	46,500	57,400	68,200	79,200
~140		15,000	29,300	42,600	55,400	68,200	81,800	94,600
~160		15,000	29,300	42,600	55,400	68,200	81,800	94,600
~180		16,900	33,700	49,000	64,400	79,200	94,600	109,900
~200		16,900	33,700	49,000	64,400	79,200	94,600	109,900
~220		19,400	38,200	55,400	72,800	90,000	107,900	125,300
~240		21,400	42,600	61,800	81,800	101,000	120,700	140,600
~260		21,400	42,600	61,800	81,800	101,000	120,700	140,600
~280		23,300	46,500	68,200	90,000	111,800	133,500	155,300
約1.5倍ヒダ		~88	~200	~300	~400	~500		

※片開きはW270cmまで

H	W	~67 1巾(片開き)	~150 2巾	~225 3巾	~300 4巾	~375 5巾	~450 6巾	~525 7巾
~100		13,000	25,700	37,200	48,500	60,000	71,300	82,800
~120		13,000	25,700	37,200	48,500	60,000	71,300	82,800
~140		15,700	30,500	44,500	57,900	71,300	85,500	98,900
~160		15,700	30,500	44,500	57,900	71,300	85,500	98,900
~180		17,600	35,100	51,200	67,300	82,800	98,900	114,900
~200		17,600	35,100	51,200	67,300	82,800	98,900	114,900
~220		20,300	39,900	57,900	76,100	94,100	112,800	131,000
~240		22,400	44,500	64,600	85,500	105,600	126,200	147,100
~260		22,400	44,500	64,600	85,500	105,600	126,200	147,100
~280		24,300	48,500	71,300	94,100	116,900	139,600	162,400
約1.5倍ヒダ		~88	~200	~300	~400	~500		

※片開きはW270cmまで

H	W	~67 1巾(片開き)	~150 2巾	~225 3巾	~300 4巾	~375 5巾	~450 6巾	~525 7巾	~600 8巾
~100		11,900	23,700	34,100	44,400	54,900	65,200	75,600	85,900
~120		11,900	23,700	34,100	44,400	54,900	65,200	75,600	85,900
~140		14,400	28,000	40,800	53,000	65,200	78,100	90,300	103,000
~160		14,400	28,000	40,800	53,000	65,200	78,100	90,300	103,000
~180		16,100	32,200	46,900	61,500	75,600	90,300	104,900	119,500
~200		16,100	32,200	46,900	61,500	75,600	90,300	104,900	119,500
~220		18,600	36,600	53,000	69,500	85,900	103,000	119,500	135,900
~240		20,500	40,800	59,100	78,100	96,400	115,200	134,200	152,500
~260		20,500	40,800	59,100	78,100	96,400	115,200	134,200	152,500
~280		22,200	44,400	65,200	85,900	106,700	127,400	148,100	168,900
約1.5倍ヒダ		~88	~200	~300	~400	~500	~600	~700	~800
フラット前ヒダ		~130	~260	~410	~560				

H	W	~67 1巾(片開き)	~150 2巾	~225 3巾	~300 4巾	~375 5巾	~450 6巾	~525 7巾	~600 8巾
~100		14,000	27,800	40,300	52,600	65,100	77,400	89,900	102,200
~120		14,000	27,800	40,300	52,600	65,100	77,400	89,900	102,200
~140		16,900	33,000	48,200	62,800	77,400	92,900	107,500	122,700
~160		16,900	33,000	48,200	62,800	77,400	92,900	107,500	122,700
~180		19,000	38,000	55,500	73,000	89,900	107,500	125,000	142,500
~200		19,000	38,000	55,500	73,000	89,900	107,500	125,000	142,500
~220		21,900	43,200	62,800	82,600	102,200	122,700	142,500	162,100
~240		24,200	48,200	70,100	92,900	114,800	137,300	160,000	181,900
~260		24,200	48,200	70,100	92,900	114,800	137,300	160,000	181,900

※片開きはW300cmまで

		コード式				ドラム式								
H	W	30~45	~90	~140	~190	~240	30~45	~90	~140	~190	~240	~290	~340	~390
50~100		15,300	19,400	23,900	33,000	37,700	18,300	22,400	26,900	36,000	40,700	48,000	57,600	62,400
~140		17,400	21,400	26,200	36,400	41,400	20,400	24,400	29,200	39,400	44,400	51,900	63,100	68,000
~180		19,700	23,800	28,800	40,200	45,300	22,700	26,800	31,800	43,200	48,300	56,000	68,800	73,800
~220		21,700	25,900	31,100	44,000	49,300	24,700	28,900	34,100	47,000	52,300	60,300	74,300	79,400
~260		25,100	29,400	34,800	50,200	55,800	28,100	32,400	37,800	53,200	58,800	66,900	83,500	88,500
~300		27,100	31,500	37,100	53,600	59,400	30,100	34,500	40,100	56,600	62,400	70,900	88,800	94,200

※ドラム式: 仕上り巾39cm以下の場合、仕上り丈は200cmまでとなります。

		コード式
H	W	18~30
50~100		19,900
~140		22,400
~180		24,800
~220		27,300
~240		29,700

		コード式				ドラム式								
H	W	30~45	~90	~140	~190	~240	30~45	~90	~140	~190	~240	~290	~340	~390
50~100		18,100	24,400	31,000	43,100	49,400	21,100	27,400	34,000	46,100	52,400	60,600	72,200	78,800
~140		20,400	27,100	34,200	47,800	54,800	23,400	30,100	37,200	50,800	57,800	66,300	79,800	86,600
~180		22,900	30,100	37,600	52,900	60,500	25,900	33,100	40,600	55,900	63,500	72,400	88,000	95,300
~220		25,200	32,700	40,700	58,000	66,200	28,200	35,700	43,700	61,000	69,200	78,400	95,400	103,000
~260		29,000	37,200	45,800	66,400	75,300	32,000	40,200	48,800	69,400	78,300	88,000	107,800	115,900
~300		31,400	40,100	49,300	71,700	81,300	34,400	43,100	52,300	74,700	84,300	94,500	116,300	125,000

※ドラム式: 仕上り巾39cm以下の場合、仕上り丈は200cmまでとなります。

		38mm (片開き/タッセルなし)					
H	W	~72	~100	~127	~155	~183	
~100		16,400	26,300	30,500	32,600	42,700	
~140		18,200	29,600	33,800	35,900	47,700	
~180		19,600	32,800	37,000	39,100	52,400	
~220		21,400	36,100	40,300	42,400	57,000	
~260		22,900	39,300	43,500	45,600	61,600	
~300		24,200	42,100	46,300	48,400	66,300	
26mm		-2,800	-2,100	-4,900	-4,200	-4,900	
18mm		-4,900	-5,600	-9,100	-9,800	-10,500	

※生地を伸ばした状態のサイズでご発注ください。

		スプリング・チェーンタイプ				
H	W	30~60	~80	~100	~120	~140
50~80		30,700	33,200	35,200	36,400	38,100
~120		32,800	35,900	37,900	39,000	40,900
~160		35,300	39,100	41,100	42,300	43,600
~200		38,500	41,500	43,700	44,900	46,200
~240			45,500	47,800	49,000	50,400

※丈は巾の3倍までが限度です。
※ロールソフト加工品は非防災品になります。

		ストレートバランス				
H	W	~100	~150	~200	~250	~300
~40		11,300	18,100	22,500	26,900	33,700

※マジックテープ仕様・裏面スポンジ付の価格になります。

		三つ山・箱ヒダバランス (約2.5倍ヒダ)				
H	W	~100	~150	~200	~250	~300
~40		9,000	12,900	16,800	21,300	22,800

※マジックテープ仕様の価格になります。

TM-54076~54079

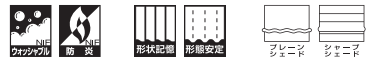

巾 ◇ 140 cm 価格 ◇ 4,900円/m
組 成 ◇ ポリエステル100%

リポート ◇ タテ 24.0 cm ヨコ 14.0 cm
寸法変化率 ◇ 水洗い/タテ -0.2% ヨコ 0.0%
ドライ/タテ 0.0% ヨコ -0.2%

取扱い表示 ◇ リ-30
防炎性能 ◇ (イ)
Made in Japan

標準仕様 形態安定加工価格表 約2倍ヒダ (タッセル含む)

H	W	~62 1巾(片開き)	~140 2巾	~210 3巾	~280 4巾	~350 5巾	~420 6巾	~490 7巾
~100		11,900	23,200	33,400	43,000	52,600	62,900	72,400
~120		13,300	26,600	38,100	49,800	60,900	72,400	84,100
~140		15,300	30,000	43,000	56,100	69,000	82,700	95,800
~160		16,700	33,400	47,800	62,900	77,300	92,400	107,500
~180		18,100	36,100	52,600	69,000	85,500	102,000	118,400
~200		18,100	36,100	52,600	69,000	85,500	102,000	118,400
~220		20,200	39,500	58,100	75,900	93,800	112,300	130,100
~240		21,600	43,000	62,900	82,700	102,000	121,900	141,800
~260		23,600	46,400	67,700	89,000	110,200	132,100	153,500
~280		25,000	49,800	72,400	95,800	118,400	141,800	165,000
約1.5倍ヒダ		~78	~184	~280	~373	~466		

※片開きはW270cmまで

プライム縫製仕様価格表 約2倍ヒダ (タッセル含む)

H	W	~62 1巾(片開き)	~140 2巾	~210 3巾	~280 4巾	~350 5巾	~420 6巾	~490 7巾
~100		12,300	24,000	34,700	44,600	54,600	65,400	75,300
~120		13,800	27,500	39,600	51,700	63,200	75,300	87,400
~140		15,900	31,100	44,600	58,200	71,700	86,000	99,600
~160		17,400	34,700	49,600	65,400	80,300	96,000	111,800
~180		18,800	37,400	54,600	71,700	88,900	106,100	123,100
~200		18,800	37,400	54,600	71,700	88,900	106,100	123,100
~220		20,900	41,000	60,300	78,800	97,500	116,800	135,300
~240		22,400	44,600	65,400	86,000	106,100	126,700	147,500
~260		24,500	48,200	70,400	92,500	114,500	137,400	159,600
~280		26,000	51,700	75,300	99,600	123,100	147,500	171,600
約1.5倍ヒダ		~78	~184	~280	~373	~466		

※片開きはW270cmまで

レギュラー縫製仕様価格表 約2倍ヒダ (タッセル含む)

H	W	~62 1巾(片開き)	~140 2巾	~210 3巾	~280 4巾	~350 5巾	~420 6巾	~490 7巾	~560 8巾
~100		11,500	22,300	32,200	41,300	50,600	60,500	69,600	79,500
~120		12,800	25,600	36,700	47,900	58,500	69,600	80,800	92,000
~140		14,800	28,900	41,300	53,900	66,300	79,500	92,000	104,600
~160		16,100	32,200	46,000	60,500	74,200	88,700	103,200	117,000
~180		17,500	34,800	50,600	66,300	82,200	98,000	113,700	129,600
~200		17,500	34,800	50,600	66,300	82,200	98,000	113,700	129,600
~220		19,400	38,100	55,800	72,900	90,100	107,900	124,900	142,700
~240		20,800	41,300	60,500	79,500	98,000	117,000	136,100	155,200
~260		22,700	44,600	65,100	85,500	105,800	126,900	147,400	167,700
~280		24,000	47,900	69,600	92,000	113,700	136,100	158,400	180,300
約1.5倍ヒダ		~78	~184	~280	~373	~466	~560	~653	~746
フラット約1倍ヒダ		~120	~240	~380	~520				

形状記憶加工価格表 約2倍ヒダ (タッセル含む)

H	W	~62 1巾(片開き)	~140 2巾	~210 3巾	~280 4巾	~350 5巾	~420 6巾	~490 7巾	~560 8巾
~100		13,200	25,600	37,200	47,800	58,700	70,200	80,900	92,400
~120		14,800	29,500	42,400	55,500	68,000	80,900	94,000	107,200
~140		17,000	33,300	47,800	62,500	77,000	92,400	107,200	121,900
~160		18,600	37,200	53,300	70,200	86,300	103,300	120,300	136,400
~180		20,200	40,100	58,700	77,000	95,600	114,200	132,500	151,100
~200		20,200	40,100	58,700	77,000	95,600	114,200	132,500	151,100
~220		22,500	44,000	64,800	84,700	104,900	125,700	145,700	166,500
~240		24,000	47,800	70,200	92,400	114,200	136,400	158,800	181,000
~260		26,300	51,700	75,700	99,500	123,200	147,900	171,900	195,700

※片開きはW300cmまで

style no.60 プレーンシェード

H	W	コード式					ドラム式							
		30~45	~90	~140	~190	~240	30~45	~90	~140	~190	~240	~290	~340	~390
50~100		15,200	19,200	28,900	32,800	37,500	18,200	22,200	31,900	35,800	40,500	52,800	57,600	62,400
~140		18,300	22,300	34,200	38,100	43,100	21,300	25,300	37,200	41,100	46,100	60,900	65,800	70,700
~180		21,200	25,300	39,600	43,500	48,600	24,200	28,300	42,600	46,500	51,600	68,200	73,300	78,300
~220		23,000	27,100	42,400	46,400	51,700	26,000	30,100	45,400	49,400	54,700	72,900	78,000	83,100
~260		25,900	30,100	47,800	51,700	57,200	28,900	33,100	50,800	54,700	60,200	80,700	86,100	91,100
~300		28,900	33,200	53,200	57,100	62,900	31,900	36,200	56,200	60,100	65,900	88,300	93,600	99,000

※ドラム式:仕上り巾39cm以下の場合、仕上り丈は200cmまでとなります。

style no.63 シャープシェード

H	W	コード式					ドラム式							
		30~45	~90	~140	~190	~240	30~45	~90	~140	~190	~240	~290	~340	~390
50~100		18,000	24,300	36,200	42,800	49,200	21,000	27,300	39,200	45,800	52,200	65,600	72,200	78,800
~140		21,300	28,000	42,600	49,600	56,600	24,300	31,000	45,600	52,600	59,600	75,600	82,600	89,400
~180		24,500	31,600	48,900	56,500	64,000	27,500	34,600	51,900	59,500	67,000	85,200	92,700	100,000
~220		26,500	34,000	52,600	60,600	68,800	29,500	37,000	55,600	63,600	71,800	91,600	99,300	106,900
~260		29,800	37,900	59,400	68,000	76,900	32,800	40,900	62,400	71,000	79,900	102,400	110,600	118,700
~300		33,200	41,900	66,100	75,400	84,900	36,200	44,900	69,100	78,400	87,900	112,800	121,400	130,000

※ドラム式:仕上り巾39cm以下の場合、仕上り丈は200cmまでとなります。

形態安定加工 推奨裏地付価格表(推奨裏地 TM-54419~54423) 約2倍ヒダ (タッセル含む)

H	W	~62 1巾(片開き)	~140 2巾	~210 3巾	~280 4巾	~350 5巾	~420 6巾	~490 7巾
~100		18,000	35,400	51,700	67,400	83,100	99,500	115,100
~120		20,300	40,600	59,000	77,700	95,700	114,200	132,900
~140		23,200	45,700	66,500	87,500	108,200	129,700	150,700
~160		25,400	50,800	73,900	97,700	120,800	144,600	168,400
~180		27,700	55,300	81,400	107,300	133,400	159,500	185,400
~200		28,600	57,000	84,000	110,800	137,700	164,700	191,500
~220		31,600	62,200	92,100	121,200	150,400	180,200	209,300
~240		33,800	67,400	99,500	131,500	162,900	195,000	227,100
~260		36,700	72,500	106,900	141,200	175,500	210,400	244,900
~280		39,000	77,700	114,200	151,500	188,000	225,400	262,500
約1.5倍ヒダ		~78	~184	~280	~373	~466		

※片開きはW270cmまで

プライム縫製仕様 推奨裏地付価格表(推奨裏地 TM-54419~54423) 約2倍ヒダ (タッセル含む)

H	W	~62 1巾(片開き)	~140 2巾	~210 3巾	~280 4巾	~350 5巾	~420 6巾	~490 7巾
~100		18,900	37,100	54,300	70,700	87,200	104,500	120,900
~120		21,300	42,400	62,000	81,500	100,400	120,000	139,500
~140		24,300	47,900	69,800	91,700	113,600	136,300	158,200
~160		26,700	53,300	77,500	102,600	126,800	151,800	176,900
~180		29,100	57,900	85,300	112,700	140,100	167,500	194,800
~200		30,000	59,800	88,100	116,400	144,700	173,100	201,300
~220		33,000	65,200	96,600	127,200	158,000	189,400	220,000
~240		35,500	70,700	104,500	138,100	171,200	204,900	238,700
~260		38,500	76,100	112,300	148,300	184,300	221,100	257,300
~280		40,900	81,500	120,000	159,200	197,500	236,800	275,800
約1.5倍ヒダ		~78	~184	~280	~373	~466		

※片開きはW270cmまで

レギュラー縫製仕様 推奨裏地付価格表(推奨裏地 TM-54419~54423) 約2倍ヒダ (タッセル含む)

H	W	~62 1巾(片開き)	~140 2巾	~210 3巾	~280 4巾	~350 5巾	~420 6巾	~490 7巾	~560 8巾
~100		17,200	33,700	49,300	64,000	79,000	94,600	109,300	124,900
~120		19,300	38,600	56,200	73,900	90,900	108,500	126,200	143,900
~140		22,100	43,500	63,200	83,100	102,800	123,300	143,100	163,000
~160		24,200	48,400	70,300	92,900	114,700	137,300	159,900	181,800
~180		26,500	52,700	77,400	102,000	126,800	151,500	176,100	200,900
~200		27,300	54,300	79,800	105,200	130,800	156,400	181,800	207,400
~220		30,000	59,200	87,400	115,100	142,800	171,100	198,700	227,000
~240		32,200	64,000	94,600	124,900	154,700	185,100	215,500	246,000
~260		34,900	68,900	101,600	134,100	166,600	199,800	232,500	264,900
~280		37,000	73,900	108,50					

TM-54080・54081



巾 ◇ 290cm ヨコ使い 価格 ◇ 14,000円/m リポート ◇ タテ 290.0cm ヨコ 16.0cm 取扱い表示 ◇ リ-30 40℃ 形状記憶 乾燥機対応 熨め布使用
 組成 ◇ ポリエステル100% 寸法変化率 ◇ 水洗い/タテ 0.2% ヨコ -0.1% 防炎性能 ◇ - ドライ/タテ -0.2% ヨコ 0.0% Made in Turkey

H	W	~50 (片開き)	~100	~150	~200	~250	~300	~350	~400
~100		17,200	32,900	48,600	64,300	80,000	95,600	111,300	127,000
~120		17,600	33,500	49,400	65,400	81,300	97,200	113,100	129,000
~140		17,800	34,000	50,200	66,300	82,500	98,600	114,800	131,000
~160		18,100	34,500	50,900	67,300	83,700	100,100	116,500	132,900
~180		18,300	35,000	51,600	68,200	84,900	101,500	118,200	134,800
~200		18,600	35,400	52,300	69,200	86,100	103,000	119,800	136,700
~220		18,900	36,000	53,200	70,300	87,400	104,500	121,600	138,800
~240		19,200	36,500	53,900	71,200	88,600	106,000	123,300	140,700
~260		19,300	36,800	54,200	71,700	89,200	106,700	124,200	141,600
~270		19,300	36,800	54,200	71,700	89,200	106,700	124,200	141,600
約1.5倍ヒダ		~60	~120	~200	~266	~333	~400	~466	~533
フラット耐1倍ヒダ		~90	~160	~260	~360	~460	~560		

H	W	~50 (片開き)	~100	~150	~200	~250	~300	~350	~400
~100		18,400	35,200	52,000	68,800	85,600	102,400	119,200	136,000
~120		19,000	36,200	53,400	70,600	87,800	105,000	122,200	139,400
~140		19,400	37,000	54,600	72,200	89,800	107,400	125,000	142,600
~160		19,800	37,800	55,800	73,800	91,800	109,800	127,800	145,800
~180		20,200	38,600	57,000	75,400	93,800	112,200	130,600	149,000
~200		20,600	39,400	58,200	77,000	95,800	114,600	133,400	152,200
~220		21,200	40,400	59,600	78,800	98,000	117,200	136,400	155,600
~240		21,600	41,200	60,800	80,400	100,000	119,600	139,200	158,800
~260		21,800	41,600	61,400	81,200	101,000	120,800	140,600	160,400

※片開きはW300cmまで

H	W	コード式					ドラム式				
		30~45	~90	~140	~190	~240	30~45	~90	~140	~190	~240
50~100		45,800	49,100	53,700	57,000	61,700	48,800	52,100	56,700	60,000	64,700
~140		46,700	50,100	54,800	58,200	63,200	49,700	53,100	57,800	61,200	66,200
~180		47,500	50,900	56,000	59,500	64,600	50,500	53,900	59,000	62,500	67,600
~220		48,300	51,900	57,100	60,700	66,100	51,300	54,900	60,100	63,700	69,100
~260		49,100	52,800	58,300	62,000	67,500	52,100	55,800	61,300	65,000	70,500
~270		85,700	88,700	94,300	97,300	103,100	88,700	91,700	97,300	100,300	106,100

※ドラム式：仕上り巾39cm以下の場合、仕上り丈は200cmまでとなります。

H	W	コード式
		18~30
50~100		47,500
~140		49,000
~180		50,000
~220		51,500
~240		52,500

style no.30 (両開き/タッセル含む)							
H	W	~100	~150	~200	~250	~300	~350
~270		33,900	50,800	67,600	84,500	101,400	118,300

TM-54084・54085



巾 ◇ 100cm 価格 ◇ 6,400円/m
組成 ◇ ポリエステル100%

リポート ◇ タテ 30.0cm ヨコ 33.3cm
寸法変化率 ◇ 水洗い/タテ -0.3% ヨコ 0.0%
ドライ/タテ -0.3% ヨコ 0.0%

取扱い表示 ◇ リ-30 30℃
防炎性能 ◇ (イ) ちて布使用
Made in Japan

標準仕様 形態安定加工価格表 約2倍ヒダ (タッセル含む)

H	W	~44 1巾(片開き)	~100 2巾	~150 3巾	~200 4巾	~250 5巾	~300 6巾	~350 7巾	~400 8巾
~100	13,600	27,200	38,900	50,600	62,300	74,000	85,700	97,400	
~120	16,000	31,900	45,900	60,000	74,000	88,000	102,100	116,100	
~140	16,000	31,900	45,900	60,000	74,000	88,000	102,100	116,100	
~160	18,300	36,600	52,900	69,300	85,700	102,100	118,500	134,800	
~180	20,600	41,200	60,000	78,700	97,400	116,100	134,800	153,600	
~200	20,600	41,200	60,000	78,700	97,400	116,100	134,800	153,600	
~220	23,000	45,900	67,000	88,000	109,100	130,200	151,200	172,300	
~240	25,300	50,600	74,000	97,400	120,800	144,200	167,600	191,000	
~260	25,300	50,600	74,000	97,400	120,800	144,200	167,600	191,000	
~280	27,700	55,300	81,000	106,800	132,500	158,200	184,000	209,700	
約1.5倍ヒダ	~56	~120	~200	~266	~333	~400	~466	~533	

※片開きはW270cmまで

プライム縫製仕様価格表 約2倍ヒダ (タッセル含む)

H	W	~44 1巾(片開き)	~100 2巾	~150 3巾	~200 4巾	~250 5巾	~300 6巾	~350 7巾	~400 8巾
~100	13,900	27,800	39,800	51,800	63,800	75,800	87,800	99,800	
~120	16,300	32,600	47,000	61,400	75,800	90,200	104,600	119,000	
~140	16,300	32,600	47,000	61,400	75,800	90,200	104,600	119,000	
~160	18,700	37,400	54,200	71,000	87,800	104,600	121,400	138,200	
~180	21,100	42,200	61,400	80,600	99,800	119,000	138,200	157,400	
~200	21,100	42,200	61,400	80,600	99,800	119,000	138,200	157,400	
~220	23,500	47,000	68,600	90,200	111,800	133,400	155,000	176,600	
~240	25,900	51,800	75,800	99,800	123,800	147,800	171,800	195,800	
~260	25,900	51,800	75,800	99,800	123,800	147,800	171,800	195,800	
~280	28,300	56,600	83,000	109,400	135,800	162,200	188,600	215,000	
約1.5倍ヒダ	~56	~120	~200	~266	~333	~400	~466	~533	

※片開きはW270cmまで

レギュラー縫製仕様価格表 約2倍ヒダ (タッセル含む)

H	W	~44 1巾(片開き)	~100 2巾	~150 3巾	~200 4巾	~250 5巾	~300 6巾	~350 7巾	~400 8巾
~100	13,300	26,600	38,000	49,400	60,800	72,200	83,600	95,000	
~120	15,600	31,200	44,800	58,500	72,200	85,900	99,600	113,200	
~140	15,600	31,200	44,800	58,500	72,200	85,900	99,600	113,200	
~160	17,900	35,700	51,700	67,600	83,600	99,600	115,500	131,500	
~180	20,200	40,300	58,500	76,800	95,000	113,200	131,500	149,700	
~200	20,200	40,300	58,500	76,800	95,000	113,200	131,500	149,700	
~220	22,400	44,800	65,400	85,900	106,400	126,900	147,400	168,000	
~240	24,700	49,400	72,200	95,000	117,800	140,600	163,400	186,200	
~260	24,700	49,400	72,200	95,000	117,800	140,600	163,400	186,200	
~280	27,000	54,000	79,000	104,100	129,200	154,300	179,400	204,400	
約1.5倍ヒダ	~56	~120	~200	~266	~333	~400	~466	~533	
フラット前ヒダ	~80	~160	~260	~360	~460	~560			

※片開きはW300cmまで

形状記憶加工価格表 約2倍ヒダ (タッセル含む)

H	W	~44 1巾(片開き)	~100 2巾	~150 3巾	~200 4巾	~250 5巾	~300 6巾	~350 7巾	~400 8巾
~100	14,500	29,000	41,600	54,200	66,800	79,400	92,000	104,600	
~120	17,000	34,000	49,200	64,300	79,400	94,500	109,600	124,800	
~140	17,000	34,000	49,200	64,300	79,400	94,500	109,600	124,800	
~160	19,600	39,100	56,700	74,400	92,000	109,600	127,300	144,900	
~180	22,100	44,100	64,300	84,400	104,600	124,800	144,900	165,100	
~200	22,100	44,100	64,300	84,400	104,600	124,800	144,900	165,100	
~220	24,600	49,200	71,800	94,500	117,200	139,900	162,600	185,200	
~240	27,100	54,200	79,400	104,600	129,800	155,000	180,200	205,400	
~260	27,100	54,200	79,400	104,600	129,800	155,000	180,200	205,400	

※片開きはW300cmまで

style no.60 プレーンシェード

H	W	コード式				ドラム式								
		30~45	~90	~140	~190	~240	30~45	~90	~140	~190	~240	~290	~340	~390
50~100	16,800	20,800	31,900	35,800	46,900	19,800	23,800	34,900	38,800	49,900	57,500	68,900	73,600	
~140	21,100	25,100	39,700	43,500	58,100	24,100	28,100	42,700	46,500	61,100	69,100	83,900	88,800	
~180	23,600	27,600	44,200	48,000	64,400	26,600	30,600	47,200	51,000	67,400	75,500	92,100	97,100	
~220	26,100	30,200	48,600	52,400	70,700	29,100	33,200	51,600	55,400	73,700	82,200	100,500	105,600	
~260	30,300	34,400	56,400	60,100	81,800	33,300	37,400	59,400	63,100	84,800	93,600	115,500	120,500	
~300	32,900	37,000	60,800	64,600	88,100	35,900	40,000	63,800	67,600	91,100	100,200	123,700	129,100	

※ドラム式：仕上り巾39cm以下の場合、仕上り丈は200cmまでとなります。

style no.63 シャープシェード

H	W	コード式				ドラム式								
		30~45	~90	~140	~190	~240	30~45	~90	~140	~190	~240	~290	~340	~390
50~100	19,600	25,900	39,400	46,000	59,300	22,600	28,900	42,400	49,000	62,300	70,500	84,000	90,600	
~140	24,200	30,800	48,300	55,400	72,700	27,200	33,800	51,300	58,400	75,700	84,200	101,500	108,400	
~180	26,900	34,000	53,700	61,300	80,900	29,900	37,000	56,700	64,300	83,900	92,800	112,400	119,700	
~220	29,700	37,200	59,100	67,100	89,100	32,700	40,200	62,100	70,100	92,100	101,300	122,800	130,500	
~260	34,300	42,400	68,400	77,000	103,100	37,300	45,400	71,400	80,000	106,100	115,900	141,300	149,500	
~300	37,200	45,900	74,200	83,400	112,000	40,200	48,900	77,200	86,400	115,000	125,200	152,900	161,500	

※ドラム式：仕上り巾39cm以下の場合、仕上り丈は200cmまでとなります。

形態安定加工 推奨裏地付価格表(推奨裏地TM-54419~54423) 約2倍ヒダ (タッセル含む)

H	W	~44 1巾(片開き)	~100 2巾	~150 3巾	~200 4巾	~250 5巾	~300 6巾	~350 7巾	~400 8巾
~100	19,700	39,400	51,100	68,900	86,700	108,500	126,300	144,100	161,900
~120	23,000	45,900	59,900	80,900	101,900	125,900	147,900	170,900	193,900
~140	23,900	47,600	61,600	83,500	105,400	129,400	151,400	174,400	197,400
~160	27,000	54,000	70,300	95,400	120,500	146,900	172,900	198,900	224,900
~180	30,200	60,400	79,200	107,500	135,700	164,400	192,900	221,400	250,400
~200	31,100	62,100	80,900	110,100	139,200	167,900	196,900	225,400	254,400
~220	34,400	68,600	89,700	122,000	154,400	175,500	207,800	240,200	270,200
~240	37,500	75,000	98,400	134,000	169,600	193,000	228,500	264,100	294,100
~260	38,400	76,700	100,100	136,600	173,000	196,400	232,900	269,300	299,300
~280	41,700	83,200	108,900	148,600	188,200	213,900	253,600	293,300	333,300
約1.5倍ヒダ	~56	~120	~200	~266	~333	~400	~466	~533	

※片開きはW270cmまで

プライム縫製仕様 推奨裏地付価格表(推奨裏地TM-54419~54423) 約2倍ヒダ (タッセル含む)

H	W	~44 1巾(片開き)	~100 2巾	~150 3巾	~200 4巾	~250 5巾	~300 6巾	~350 7巾	~400 8巾
~100	20,500	40,900	52,900	71,400	89,900	109,900	129,900	149,900	169,900
~120	23,800	47,500	61,900	83,800	105,600	129,600	149,600	169,600	189,600
~140	24,700	49,400	63,800	86,600	109,300	129,700	149,700	169,700	189,700
~160	28,000	56,000	72,800	98,900	125,000	149,000	169,000	189,000	209,000
~180	31,400	62,700	81,900	111,300	140,800	160,000	180,000	200,000	220,000
~200	32,300	64,600	83,800	114,100	144,500	163,700	183,700	203,700	223,700
~220	35,600	71,200	92,800	126,500	160,200	181,800	215,500	247,200	278,700
~240	39,000	77,900	101,900	138,900	175,900	199,900	236,900	274,000	305,000
~260	39,900	79,700	103,700	141,700	179,600	203,600	241,600	279,500	310,000
~280	43,200	86,400	112,800	154,100	195,400	221,800	263,000	304,300	335,300
約1.5倍ヒダ	~56	~120	~200	~266	~333	~400	~466	~533	

※片開きはW270cmまで

レギュラー縫製仕様 推奨裏地付価格表(推奨裏地TM-54419~54423) 約2倍ヒダ (タッセル含む)

H	W	~44 1巾(片開き)	~100 2巾	~150 3巾	~200 4巾	~250 5巾	~300 6巾	~350 7巾	~400 8巾
~100	19,000	38,000	49,400	66,500	83,500	94,900	112,000	129,100	
~120	22,100	44,200	57,800	78,000					

TM-54090



巾 ◇ 100cm 価格 ◇ 6,000円/m リポート ◇ タテ40.7cm ヨコ50.0cm 取扱い表示 ◇ リ-30 40 防炎性能 ◇ (イ) であて布使用
 組成 ◇ ポリエステル100% 寸法変化率 ◇ 水洗い/タテ -0.5% ヨコ -0.5% ドライ/タテ 0.2% ヨコ -0.3% Made in Japan

標準仕様 形態安定加工価格表 約2倍ヒダ (タッセル含む)

H	W	~44 1巾(片開き)	~100 2巾	~150 3巾	~200 4巾	~250 5巾	~300 6巾	~350 7巾	~400 8巾
~100		14,400	28,100	39,900	52,500	64,300	76,200	88,000	100,600
~120		14,400	28,100	39,900	52,500	64,300	76,200	88,000	100,600
~140		17,400	34,000	48,800	64,300	79,100	94,700	109,500	124,300
~160		17,400	34,000	48,800	64,300	79,100	94,700	109,500	124,300
~180		20,300	39,900	58,400	76,200	94,700	112,400	130,200	148,700
~200		20,300	39,900	58,400	76,200	94,700	112,400	130,200	148,700
~220		23,300	45,800	67,300	88,000	109,500	130,200	151,600	172,400
~240		23,300	45,800	67,300	88,000	109,500	130,200	151,600	172,400
~260		26,300	52,500	76,200	100,600	124,300	148,700	172,400	196,800
~280		26,300	52,500	76,200	100,600	124,300	148,700	172,400	196,800
約1.5倍ヒダ		~56	~120	~200	~266	~333	~400	~466	~533

※片開きはW270cmまで

プライム縫製仕様価格表 約2倍ヒダ (タッセル含む)

H	W	~44 1巾(片開き)	~100 2巾	~150 3巾	~200 4巾	~250 5巾	~300 6巾	~350 7巾	~400 8巾
~100		14,800	28,700	40,900	53,800	66,000	78,100	90,300	103,200
~120		14,800	28,700	40,900	53,800	66,000	78,100	90,300	103,200
~140		17,800	34,800	50,000	66,000	81,200	97,100	112,300	127,500
~160		17,800	34,800	50,000	66,000	81,200	97,100	112,300	127,500
~180		20,800	40,900	59,900	78,100	97,100	115,400	133,600	152,600
~200		20,800	40,900	59,900	78,100	97,100	115,400	133,600	152,600
~220		23,900	47,000	69,000	90,300	112,300	133,600	155,600	176,900
~240		23,900	47,000	69,000	90,300	112,300	133,600	155,600	176,900
~260		26,900	53,800	78,100	103,200	127,500	152,600	176,900	202,000
~280		26,900	53,800	78,100	103,200	127,500	152,600	176,900	202,000
約1.5倍ヒダ		~56	~120	~200	~266	~333	~400	~466	~533

※片開きはW270cmまで

レギュラー縫製仕様価格表 約2倍ヒダ (タッセル含む)

H	W	~44 1巾(片開き)	~100 2巾	~150 3巾	~200 4巾	~250 5巾	~300 6巾	~350 7巾	~400 8巾
~100		14,100	27,400	38,900	51,200	62,700	74,200	85,700	98,000
~120		14,100	27,400	38,900	51,200	62,700	74,200	85,700	98,000
~140		17,000	33,200	47,600	62,700	77,100	92,200	106,600	121,000
~160		17,000	33,200	47,600	62,700	77,100	92,200	106,600	121,000
~180		19,800	38,900	56,900	74,200	92,200	109,500	126,800	144,800
~200		19,800	38,900	56,900	74,200	92,200	109,500	126,800	144,800
~220		22,700	44,700	65,600	85,700	106,600	126,800	147,600	167,800
~240		22,700	44,700	65,600	85,700	106,600	126,800	147,600	167,800
~260		25,600	51,200	74,200	98,000	121,000	144,800	167,800	191,600
~280		25,600	51,200	74,200	98,000	121,000	144,800	167,800	191,600
約1.5倍ヒダ		~56	~120	~200	~266	~333	~400	~466	~533
フラット前ヒダ		~80	~160	~260	~360	~460	~560		

形状記憶加工価格表 約2倍ヒダ (タッセル含む)

H	W	~44 1巾(片開き)	~100 2巾	~150 3巾	~200 4巾	~250 5巾	~300 6巾	~350 7巾	~400 8巾
~100		15,400	30,000	42,800	56,400	69,200	82,000	94,800	108,400
~120		15,400	30,000	42,800	56,400	69,200	82,000	94,800	108,400
~140		18,600	36,400	52,400	69,200	85,200	102,000	118,000	134,000
~160		18,600	36,400	52,400	69,200	85,200	102,000	118,000	134,000
~180		21,800	42,800	62,800	82,000	102,000	121,200	140,400	160,400
~200		21,800	42,800	62,800	82,000	102,000	121,200	140,400	160,400
~220		25,000	49,200	72,400	94,800	118,000	140,400	163,600	186,000
~240		25,000	49,200	72,400	94,800	118,000	140,400	163,600	186,000
~260		28,200	56,400	82,000	108,400	134,000	160,400	186,000	212,400
~280		28,200	56,400	82,000	108,400	134,000	160,400	186,000	212,400

※片開きはW300cmまで

オーセンティック

style no.60 プレーンシェード

H	W	コード式				ドラム式								
		30~45	~90	~140	~190	30~45	~90	~140	~190	~240	~290	~340	~390	
50~100		16,900	20,900	31,600	35,500	46,200	19,900	23,900	34,600	38,500	49,200	56,700	67,700	72,500
~140		19,900	23,900	36,900	40,800	53,800	22,900	26,900	39,900	43,800	56,800	64,600	78,300	83,200
~180		22,800	26,900	42,200	46,000	61,200	25,800	29,900	45,200	49,000	64,200	72,300	88,200	93,200
~220		25,800	29,900	47,500	51,300	69,300	28,800	32,900	50,500	54,300	72,300	80,700	98,200	103,300
~260		28,700	32,900	52,800	56,600	76,700	31,700	35,900	55,800	59,600	79,700	88,400	108,300	113,300
~300		31,700	35,900	58,600	62,300	84,300	34,700	38,900	61,600	65,300	87,300	96,300	118,700	124,000

※ドラム式: 仕上り巾39cm以下の場合、仕上り丈は200cmまでとなります。

スリムシェード

H	W	コード式
50~100		18~30
~140		21,300
~180		24,700
~220		27,600
~260		31,000
~300		34,000

style no.63 シャープシェード

H	W	コード式				ドラム式								
		30~45	~90	~140	~190	30~45	~90	~140	~190	~240	~290	~340	~390	
50~100		19,700	26,000	39,100	45,700	58,600	22,700	29,000	42,100	48,700	61,600	69,700	82,800	89,400
~140		23,000	29,700	45,400	52,400	68,100	26,000	32,700	48,400	55,400	71,100	79,600	95,700	102,600
~180		26,100	33,300	51,600	59,200	77,500	29,100	36,300	54,600	62,200	80,500	89,400	108,300	115,600
~220		29,400	36,900	57,900	65,900	87,600	32,400	39,900	60,900	68,900	90,600	99,800	120,400	128,100
~260		32,700	40,800	64,600	73,200	97,700	35,700	43,800	67,600	76,200	100,700	110,500	133,700	141,900
~300		36,000	44,700	71,800	81,000	107,900	39,000	47,700	74,800	84,000	110,900	121,100	147,600	156,200

※ドラム式: 仕上り巾39cm以下の場合、仕上り丈は200cmまでとなります。

ハトメカーテン 約1.8倍ヒダ

H	W	38mm	片開き/タッセルなし			
~72		~100	~127	~155	~183	
~100		26,900	29,000	42,200	44,300	55,900
~140		31,400	33,500	48,900	51,000	64,900
~180		35,900	38,000	56,200	58,300	73,800
~220		40,400	42,500	62,900	65,000	82,800
~260		45,400	47,500	69,600	71,700	92,300
~300		49,900	52,000	76,300	78,400	101,300
26mm		-2,800	-2,100	-4,900	-4,200	-4,900
18mm		-4,900	-5,600	-9,100	-9,800	-10,500

※生地を伸ばした状態のサイズでご発注ください。

style no.S01 ロールソフト

スプリング・チェーンタイプ				
H	W			
50~80		30~60		
~120		~80		
~160		~90		
~200		32,100	34,600	36,600
~240		35,100	38,200	40,200
~280		38,100	41,900	43,900
~320		42,200	45,200	47,400
~360		48,800	51,100	

※丈は巾の3倍までが限度です。
※ロールソフト加工品は非防炎品になります。

バランス

ストレートバランス						
H	W	~100	~150	~200	~250	~300
~40		17,000	21,400	29,600	34,000	42,300

※マジックテープ仕様・裏面スポンジ付の価格になります。

三ツ山・箱ヒダバランス (約2.5倍ヒダ)

H	W	~100	~150	~200	~250	~300
~40		16,100	21,500	26,800	37,000	42,800

※マジックテープ仕様の価格になります。

TM-54091・54092



巾 ◇ 100cm 価格 ◇ 6,000円/m
組成 ◇ ポリエステル100%

リポート ◇ タテ 39.5cm ヨコ 33.5cm
寸法変化率 ◇ 水洗い/タテ -0.3% ヨコ -0.7%
ドライ/タテ -0.3% ヨコ -0.3%

取扱い表示 ◇ リ-30 30 30 30 30 30 30
防炎性能 ◇ (イ) あて布使用
Made in Japan

標準仕様 形態安定加工価格表 約2倍ヒダ (タッセル含む)

H	W	~44 1巾(片開き)	~100 2巾	~150 3巾	~200 4巾	~250 5巾	~300 6巾	~350 7巾	~400 8巾
~100		13,700	27,300	39,200	51,000	62,100	73,900	85,800	97,600
~120		13,700	27,300	39,200	51,000	62,100	73,900	85,800	97,600
~140		16,600	33,200	48,000	62,100	76,900	91,700	106,500	120,600
~160		16,600	33,200	48,000	62,100	76,900	91,700	106,500	120,600
~180		19,600	39,200	56,900	73,900	91,700	109,500	126,500	144,200
~200		19,600	39,200	56,900	73,900	91,700	109,500	126,500	144,200
~220		22,600	45,100	65,100	85,800	106,500	126,500	147,200	167,900
~240		22,600	45,100	65,100	85,800	106,500	126,500	147,200	167,900
~260		25,500	51,000	73,900	97,600	120,600	144,200	167,900	190,900
~280		28,500	56,900	82,800	109,500	135,400	162,000	187,900	214,500
約1.5倍ヒダ		~56	~120	~200	~266	~333	~400	~466	~533

※片開きはW270cmまで

プライム縫製仕様価格表 約2倍ヒダ (タッセル含む)

H	W	~44 1巾(片開き)	~100 2巾	~150 3巾	~200 4巾	~250 5巾	~300 6巾	~350 7巾	~400 8巾
~100		14,000	28,000	40,100	52,300	63,700	75,800	88,000	100,200
~120		14,000	28,000	40,100	52,300	63,700	75,800	88,000	100,200
~140		17,000	34,000	49,200	63,700	78,900	94,100	109,300	123,700
~160		17,000	34,000	49,200	63,700	78,900	94,100	109,300	123,700
~180		20,100	40,100	58,400	75,800	94,100	112,300	129,800	148,000
~200		20,100	40,100	58,400	75,800	94,100	112,300	129,800	148,000
~220		23,100	46,200	66,700	88,000	109,300	129,800	151,100	172,400
~240		23,100	46,200	66,700	88,000	109,300	129,800	151,100	172,400
~260		26,200	52,300	75,800	100,200	123,700	148,000	172,400	195,900
~280		29,200	58,400	85,000	112,300	138,900	166,300	192,900	220,200
約1.5倍ヒダ		~56	~120	~200	~266	~333	~400	~466	~533

※片開きはW270cmまで

レギュラー縫製仕様価格表 約2倍ヒダ (タッセル含む)

H	W	~44 1巾(片開き)	~100 2巾	~150 3巾	~200 4巾	~250 5巾	~300 6巾	~350 7巾	~400 8巾
~100		13,400	26,700	38,200	49,700	60,500	72,000	83,600	95,100
~120		13,400	26,700	38,200	49,700	60,500	72,000	83,600	95,100
~140		16,200	32,400	46,800	60,500	74,900	89,300	103,700	117,400
~160		16,200	32,400	46,800	60,500	74,900	89,300	103,700	117,400
~180		19,100	38,200	55,500	72,000	89,300	106,600	123,200	140,400
~200		19,100	38,200	55,500	72,000	89,300	106,600	123,200	140,400
~220		22,000	44,000	63,400	83,600	103,700	123,200	143,300	163,500
~240		22,000	44,000	63,400	83,600	103,700	123,200	143,300	163,500
~260		24,900	49,700	72,000	95,100	117,400	140,400	163,500	185,800
~280		27,800	55,500	80,700	106,600	131,800	157,700	182,900	208,800
約1.5倍ヒダ		~56	~120	~200	~266	~333	~400	~466	~533
フラット約1倍ヒダ		~80	~160	~260	~360	~460	~560		

形状記憶加工価格表 約2倍ヒダ (タッセル含む)

H	W	~44 1巾(片開き)	~100 2巾	~150 3巾	~200 4巾	~250 5巾	~300 6巾	~350 7巾	~400 8巾
~100		14,600	29,200	42,000	54,800	66,800	79,600	92,400	105,200
~120		14,600	29,200	42,000	54,800	66,800	79,600	92,400	105,200
~140		17,800	35,600	51,600	66,800	82,800	98,800	114,800	130,000
~160		17,800	35,600	51,600	66,800	82,800	98,800	114,800	130,000
~180		21,000	42,000	61,200	79,600	98,800	118,000	136,400	155,600
~200		21,000	42,000	61,200	79,600	98,800	118,000	136,400	155,600
~220		24,200	48,400	70,000	92,400	114,800	136,400	158,800	181,200
~240		24,200	48,400	70,000	92,400	114,800	136,400	158,800	181,200
~260		27,400	54,800	79,600	105,200	130,000	155,600	181,200	206,000

※片開きはW300cmまで

style no.60 プレーンシェード

コード式					ドラム式									
H	W	30~45	~90	~140	~190	~240	30~45	~90	~140	~190	~240	~290	~340	~390
50~100		16,400	20,400	31,100	35,000	45,700	19,400	23,400	34,100	38,000	48,700	56,200	67,200	72,000
~140		19,400	23,400	36,400	40,300	53,300	22,400	26,400	39,400	43,300	56,300	64,100	77,300	82,200
~180		22,300	26,300	41,700	45,500	60,700	25,300	29,300	44,700	48,500	63,700	71,800	86,600	91,600
~220		25,300	29,400	47,000	50,800	68,200	28,300	32,400	50,000	53,800	71,200	79,700	96,700	101,800
~260		28,200	32,400	52,200	56,100	75,200	31,200	35,400	55,200	59,100	78,200	86,800	106,800	111,800
~300		33,300	37,500	61,600	65,400	88,800	36,300	40,500	64,600	68,400	91,800	100,900	124,900	130,200

※ドラム式：仕上り巾39cm以下の場合、仕上り丈は200cmまでとなります。

style no.63 シャープシェード

コード式					ドラム式									
H	W	30~45	~90	~140	~190	~240	30~45	~90	~140	~190	~240	~290	~340	~390
50~100		19,200	25,500	38,600	45,200	58,000	22,200	28,500	41,600	48,200	61,000	69,200	82,300	88,800
~140		22,400	29,100	44,900	51,900	67,500	25,400	32,100	47,900	54,900	70,500	79,100	94,600	101,500
~180		25,600	32,700	51,100	58,700	77,000	28,600	35,700	54,100	61,700	80,000	88,900	106,700	114,000
~220		28,800	36,400	57,400	65,400	86,500	31,800	39,400	60,400	68,400	89,500	98,700	118,800	126,500
~260		32,100	40,300	64,000	72,700	96,100	35,100	43,300	67,000	75,700	99,100	108,900	132,100	140,300
~300		37,700	46,300	75,000	84,300	112,700	40,700	49,300	78,000	87,300	115,700	126,000	154,100	162,700

※ドラム式：仕上り巾39cm以下の場合、仕上り丈は200cmまでとなります。

形態安定加工 推奨裏地付価格表(推奨裏地TM-54419~54423) 約2倍ヒダ (タッセル含む)

H	W	~44 1巾(片開き)	~100 2巾	~150 3巾	~200 4巾	~250 5巾	~300 6巾	~350 7巾	~400 8巾
~100		19,800	39,500	51,400	69,300	86,500	98,300	116,300	134,200
~120		20,700	41,300	53,200	71,900	90,000	101,800	120,600	139,400
~140		24,500	48,900	63,700	85,600	108,300	123,100	145,700	167,600
~160		25,300	50,600	65,400	88,200	111,700	126,500	150,000	172,800
~180		29,200	58,400	76,100	102,700	130,000	147,800	174,400	201,700
~200		30,100	60,100	77,800	105,300	133,500	151,300	178,700	206,900
~220		34,000	67,800	87,800	119,800	151,800	171,800	203,800	235,800
~240		34,800	69,500	89,500	122,400	155,300	175,300	208,100	241,000
~260		38,600	77,100	100,000	136,800	172,800	196,400	233,200	269,200
~280		42,500	84,800	110,700	151,300	191,100	217,700	257,500	298,100
約1.5倍ヒダ		~56	~120	~200	~266	~333	~400	~466	~533

※片開きはW270cmまで

プライム縫製仕様 推奨裏地付価格表(推奨裏地TM-54419~54423) 約2倍ヒダ (タッセル含む)

H	W	~44 1巾(片開き)	~100 2巾	~150 3巾	~200 4巾	~250 5巾	~300 6巾	~350 7巾	~400 8巾
~100		20,600	41,100	53,200	71,900	89,800	101,900	120,600	139,300
~120		21,500	42,900	55,000	74,700	93,500	105,600	125,200	144,900
~140		25,400	50,800	66,000	88,900	112,400	127,600	151,200	174,000
~160		26,300	52,600	67,800	91,600	116,100	131,300	155,800	179,500
~180		30,400	60,600	78,900	106,500	135,100	153,300	181,000	209,400
~200		31,300	62,500	80,800	109,300	138,800	157,000	185,600	215,000
~220		35,200	70,400	90,900	124,300	157,700	178,200	211,600	245,000
~240		36,200	72,300	92,800	127,100	161,400	181,900	216,200	250,600
~260		40,200	80,200	103,700	142,100	179,500	203,800	242,200	279,600
~280		44,100	88,200	114,800	157,000	198,500	225,900	267,300	309,500
約1.5倍ヒダ		~56	~120	~200	~266	~333	~400	~466	~533

※片開きはW270cmまで

レギュラー縫製仕様 推奨裏地付価格表(推奨裏地TM-54419~54423) 約2倍ヒダ (タッセル含む)

H	W	~44 1巾(片開き)	~100 2巾	~150 3巾	~200 4巾	~250 5巾	~300 6巾	~350 7巾	~400 8巾
~100		19,100	38,100	49,600	66,800	83,200	94,700	112,000	129,200
~120		19,900	39,700	51,200	69,200	86,500	98,000	116,000	134,000
~140		23,500	47,000	61,400	82,400	104,100	118,500	140,200	161,200
~160		24,300	48,600	63,000	84,800	107,300	121,700	144,200	166,000
~180		28,100	56,100	73,400	98,800	125,000	142,300	167,800	193,900
~200		28,900	57,700	75,000	101,200	128,200	145,500	171,800	198,800
~220		32,600	65,100	84,500					

TM-54093・54094



巾 ◇ 140cm 価格 ◇ 11,600円/m リポート ◇ タテ 36.4cm ヨコ 35.0cm 取扱い表示 ◇ リ-30 防炎性能 ◇ (イ) 扱い布使用
 組成 ◇ ポリエステル100% 寸法変化率 ◇ 水洗い/タテ -0.2% ヨコ -0.2% ドライ/タテ 0.2% ヨコ 0.0% Made in Japan

H	W	~62 1巾(片開き)	~140 2巾	~210 3巾	~280 4巾	~350 5巾	~420 6巾	~490 7巾
~100		23,300	46,600	65,600	85,900	104,800	125,200	144,200
~120		28,800	56,100	80,500	104,800	129,200	155,000	179,400
~140		28,800	56,100	80,500	104,800	129,200	155,000	179,400
~160		32,800	65,600	95,300	125,200	155,000	183,500	213,300
~180		32,800	65,600	95,300	125,200	155,000	183,500	213,300
~200		38,200	75,000	110,300	144,200	179,400	213,300	248,700
~220		43,600	85,900	125,200	164,600	203,800	243,200	282,600
~240		43,600	85,900	125,200	164,600	203,800	243,200	282,600
~260		47,700	95,300	140,200	183,500	228,300	273,000	317,800
~280		47,700	95,300	140,200	183,500	228,300	273,000	317,800
約1.5倍ヒダ		~78	~184	~280	~373	~466		

※片開きはW270cmまで

H	W	~62 1巾(片開き)	~140 2巾	~210 3巾	~280 4巾	~350 5巾	~420 6巾	~490 7巾
~100		23,700	47,400	66,800	87,600	106,900	127,600	147,100
~120		29,300	57,100	82,000	106,900	131,800	158,100	183,000
~140		29,300	57,100	82,000	106,900	131,800	158,100	183,000
~160		33,400	66,800	97,200	127,600	158,100	187,100	217,600
~180		33,400	66,800	97,200	127,600	158,100	187,100	217,600
~200		38,900	76,400	112,500	147,100	183,000	217,600	253,700
~220		44,500	87,600	127,600	167,800	207,900	248,100	288,300
~240		44,500	87,600	127,600	167,800	207,900	248,100	288,300
~260		48,600	97,200	143,000	187,100	232,900	278,600	324,200
~280		48,600	97,200	143,000	187,100	232,900	278,600	324,200
約1.5倍ヒダ		~78	~184	~280	~373	~466		

※片開きはW270cmまで

H	W	~62 1巾(片開き)	~140 2巾	~210 3巾	~280 4巾	~350 5巾	~420 6巾	~490 7巾	~560 8巾
~100		22,900	45,700	64,400	84,300	102,800	122,700	141,400	161,300
~120		28,200	55,000	78,900	102,800	126,700	152,000	175,800	199,700
~140		28,200	55,000	78,900	102,800	126,700	152,000	175,800	199,700
~160		32,200	64,400	93,500	122,700	152,000	179,800	209,000	238,300
~180		32,200	64,400	93,500	122,700	152,000	179,800	209,000	238,300
~200		37,400	73,600	108,200	141,400	175,800	209,000	243,600	276,800
~220		42,800	84,300	122,700	161,300	199,700	238,300	276,800	315,300
~240		42,800	84,300	122,700	161,300	199,700	238,300	276,800	315,300
~260		46,800	93,500	137,400	179,800	223,700	267,500	311,300	353,800
~280		46,800	93,500	137,400	179,800	223,700	267,500	311,300	353,800
約1.5倍ヒダ		~78	~184	~280	~373	~466	~560	~653	~746
フラット約1倍ヒダ		~120	~240	~380	~520				

H	W	~62 1巾(片開き)	~140 2巾	~210 3巾	~280 4巾	~350 5巾	~420 6巾	~490 7巾	~560 8巾
~100		24,600	49,100	69,300	90,900	111,000	132,600	152,800	174,400
~120		30,400	59,200	85,100	111,000	136,800	164,300	190,200	216,000
~140		30,400	59,200	85,100	111,000	136,800	164,300	190,200	216,000
~160		34,700	69,300	100,800	132,600	164,300	194,400	226,200	257,900
~180		34,700	69,300	100,800	132,600	164,300	194,400	226,200	257,900
~200		40,300	79,200	116,800	152,800	190,200	226,200	263,700	299,700
~220		46,200	90,900	132,600	174,400	216,000	257,900	299,700	341,400
~240		46,200	90,900	132,600	174,400	216,000	257,900	299,700	341,400
~260		50,400	100,800	148,500	194,400	242,100	289,600	337,100	383,200

※片開きはW300cmまで

H	W	コード式				ドラム式								
		30~45	~90	~140	~190	~240	30~45	~90	~140	~190	~240	~290	~340	~390
50~100		25,400	29,100	48,700	52,100	56,800	28,400	32,100	51,700	55,100	59,800	81,500	86,300	91,100
~140		30,300	34,100	56,800	60,200	65,100	33,300	37,100	59,800	63,200	68,100	94,200	99,100	104,000
~180		34,200	38,000	64,900	68,300	73,400	37,200	41,000	67,900	71,300	76,400	106,700	111,700	116,700
~220		39,200	42,900	73,100	76,300	81,700	42,200	45,900	76,100	79,300	84,700	119,300	124,500	129,600
~260		44,000	47,800	82,200	85,300	90,900	47,000	50,800	85,200	88,300	93,900	131,800	137,300	142,300
~300		48,000	51,800	90,300	93,400	99,200	51,000	54,800	93,300	96,400	102,200	144,500	149,800	155,200

※ドラム式:仕上り巾39cm以下の場合、仕上り丈は200cmまでとなります。

H	W	コード式				ドラム式								
		30~45	~90	~140	~190	~240	30~45	~90	~140	~190	~240	~290	~340	~390
50~100		28,400	34,700	56,900	63,500	69,900	31,400	37,700	59,900	66,500	72,900	95,700	102,300	108,800
~140		33,600	40,300	66,200	73,300	80,200	36,600	43,300	69,200	76,300	83,200	110,600	117,500	124,300
~180		37,800	44,900	75,400	83,000	90,500	40,800	47,900	78,400	86,000	93,500	125,400	132,900	140,200
~220		43,000	50,600	84,700	92,700	100,800	46,000	53,600	87,700	95,700	103,800	140,300	147,900	155,600
~260		48,300	56,500	95,400	104,000	112,900	51,300	59,500	98,400	107,000	115,900	155,900	164,100	172,200
~300		52,700	61,400	105,100	114,300	123,900	55,700	64,400	108,100	117,300	126,900	171,600	180,200	188,900

※ドラム式:仕上り巾39cm以下の場合、仕上り丈は200cmまでとなります。

H	W	~62 1巾(片開き)	~140 2巾	~210 3巾	~280 4巾	~350 5巾	~420 6巾	~490 7巾
~100		29,400	58,800	83,900	110,300	135,300	161,800	186,900
~120		35,800	70,100	101,400	132,700	164,000	196,800	228,200
~140		36,700	71,800	104,000	136,200	168,400	202,000	234,300
~160		41,500	83,000	121,400	160,000	198,500	235,700	274,200
~180		42,400	84,800	124,100	163,500	202,900	241,000	280,300
~200		48,700	95,900	141,700	186,000	231,600	276,000	321,800
~220		55,000	108,600	159,200	209,900	260,400	311,100	361,800
~240		55,800	110,300	161,800	213,400	264,700	316,300	367,900
~260		60,800	121,400	179,400	235,700	293,600	351,300	409,200
~280		61,700	123,200	182,000	239,200	297,900	356,600	415,300
約1.5倍ヒダ		~78	~184	~280	~373	~466		

※片開きはW270cmまで

H	W	~62 1巾(片開き)	~140 2巾	~210 3巾	~280 4巾	~350 5巾	~420 6巾	~490 7巾
~100		30,300	60,500	86,400	113,700	139,500	166,700	192,700
~120		36,800	72,000	104,400	136,700	169,000	202,800	235,100
~140		37,700	73,900	107,200	140,400	173,700	208,400	241,600
~160		42,700	85,400	125,100	164,800	204,600	242,900	282,700
~180		43,700	87,300	127,900	168,600	209,300	248,500	289,300
~200		50,100	98,800	146,000	191,800	238,800	284,600	331,900
~220		56,600	111,800	163,900	216,200	268,400	320,700	373,000
~240		57,600	113,700	166,700	219,900	273,000	326,300	379,500
~260		62,600	125,100	184,900	242,900	302,700	362,300	421,900
~280		63,500	127,000	187,700	246,700	307,300	367,900	428,400
約1.5倍ヒダ		~78	~184	~280	~373	~466		

※片開きはW270cmまで

H	W	~62 1巾(片開き)	~140 2巾	~210 3巾	~280 4巾	~350 5巾	~420 6巾	~490 7巾	~560 8巾
~100		28,600	57,100	81,500	107,000	131,200	156,800	181,100	206,700
~120		34,700	68,000	98,400	128,800	159,100	190,900	221,200	251,600
~140		35,500	69,600	100,800	132,000	163,200	195,800	226,900	258,100
~160		40,300	80,600	117,800	155,100	192,500	228,400	265,700	303,100
~180		41,200	82,300	120,300	158,400	196,600	233,300	271,400	309,600
~200		47,200	93,100	137,400	180,300	224,400	267,400	311,700	354,600
~220		53,400	105,400	154,300	203,500	252,400	301,500	350,600	399,600
~240		54,200	107,000	156,800	206,700	256,400	306,400	356,200	406,100
~260		59,000	117,800	173,900	228,400	284,500	340,400	396,400	451,000
~280		59,800	119,500	176,300	231,700	288,500	345,300	402,100	457,500
約1.5倍ヒダ		~78	~184	~280	~373	~466</			

TM-54095・54096



巾 ◇ 100cm 価格 ◇ 6,000円/m
組成 ◇ ポリエステル100%

リポート ◇ タテ 18.6cm ヨコ 11.1cm
寸法変化率 ◇ 水洗い/タテ 0.7% ヨコ 0.2%
ドライ/タテ -0.2% ヨコ 0.4%

取扱い表示 ◇ リ-30
防炎性能 ◇ (イ) あて布使用
Made in Japan

標準仕様 形態安定加工価格表 約2倍ヒダ (タッセル含む)

H	W	~44 1巾(片開き)	~100 2巾	~150 3巾	~200 4巾	~250 5巾	~300 6巾	~350 7巾	~400 8巾
~100	12,900	25,800	36,900	48,000	59,100	70,200	81,300	91,700	102,800
~120	14,400	28,800	41,400	53,200	65,800	78,400	91,000	102,800	114,600
~140	15,900	31,800	45,100	59,100	72,500	86,500	100,600	113,900	127,200
~160	17,400	34,000	49,500	64,300	79,900	94,700	110,200	125,000	140,600
~180	18,900	36,900	53,200	70,200	86,500	102,800	119,800	136,100	152,200
~200	20,300	39,900	57,700	75,400	93,200	110,900	129,400	147,200	163,800
~220	21,100	42,100	62,100	81,300	100,600	119,800	139,100	158,300	175,400
~240	22,600	45,100	65,800	86,500	107,200	128,000	148,700	169,400	187,000
~260	25,500	51,000	73,900	97,600	121,300	144,200	167,900	190,900	208,600
~280	27,000	53,200	78,400	102,800	128,000	152,400	177,500	202,000	220,200
約1.5倍ヒダ	~56	~120	~200	~266	~333	~400	~466	~533	

※片開きはW270cmまで

プライム縫製仕様価格表 約2倍ヒダ (タッセル含む)

H	W	~44 1巾(片開き)	~100 2巾	~150 3巾	~200 4巾	~250 5巾	~300 6巾	~350 7巾	~400 8巾
~100	13,200	26,400	37,800	49,200	60,600	72,000	83,400	94,100	105,500
~120	14,800	29,500	42,400	54,600	67,500	80,400	93,300	105,500	117,900
~140	16,300	32,500	46,200	60,600	74,300	88,800	103,200	116,900	130,900
~160	17,800	34,800	50,800	66,000	81,900	97,100	113,100	128,300	143,900
~180	19,300	37,800	54,600	72,000	88,800	105,500	123,000	139,700	156,900
~200	20,800	40,900	59,100	77,400	95,600	113,800	132,800	151,100	169,900
~220	21,600	43,200	63,700	83,400	103,200	123,000	142,700	162,500	182,900
~240	23,100	46,200	67,500	88,800	110,000	131,300	152,600	173,900	195,900
~260	26,200	52,300	75,800	100,200	124,500	148,000	172,400	195,900	218,900
~280	27,700	54,600	80,400	105,500	131,300	156,400	182,200	207,300	231,900
約1.5倍ヒダ	~56	~120	~200	~266	~333	~400	~466	~533	

※片開きはW270cmまで

レギュラー縫製仕様価格表 約2倍ヒダ (タッセル含む)

H	W	~44 1巾(片開き)	~100 2巾	~150 3巾	~200 4巾	~250 5巾	~300 6巾	~350 7巾	~400 8巾
~100	12,600	25,200	36,000	46,800	57,600	68,400	79,200	89,300	100,000
~120	14,100	28,100	40,400	51,900	64,100	76,400	88,600	100,100	112,000
~140	15,500	31,000	44,000	57,600	70,600	84,300	98,000	110,900	124,000
~160	17,000	33,200	48,300	62,700	77,800	92,200	107,300	121,700	136,000
~180	18,400	36,000	51,900	68,400	84,300	100,100	116,700	132,500	148,000
~200	19,800	38,900	56,200	73,500	90,800	108,000	126,000	143,300	160,000
~220	20,600	41,100	60,500	79,200	98,000	116,700	135,400	154,100	172,000
~240	22,000	44,000	64,100	84,300	104,400	124,600	144,800	164,900	184,000
~260	24,900	49,700	72,000	95,100	118,100	140,400	163,500	185,800	206,000
~280	26,300	51,900	76,400	100,100	124,600	148,400	172,800	196,600	218,000
約1.5倍ヒダ	~56	~120	~200	~266	~333	~400	~466	~533	
フラット前ヒダ	~80	~160	~260	~360	~460	~560			

形状記憶加工価格表 約2倍ヒダ (タッセル含む)

H	W	~44 1巾(片開き)	~100 2巾	~150 3巾	~200 4巾	~250 5巾	~300 6巾	~350 7巾	~400 8巾
~100	13,800	27,600	39,600	51,600	63,600	75,600	87,600	98,800	110,000
~120	15,400	30,800	44,400	57,200	70,800	84,400	98,000	110,800	124,000
~140	17,000	34,000	48,400	63,600	78,000	93,200	108,400	122,800	138,000
~160	18,600	36,400	53,200	69,200	86,000	102,000	118,800	134,800	150,000
~180	20,200	39,600	57,200	75,600	93,200	110,800	129,200	146,800	166,000
~200	21,800	42,800	62,000	81,200	100,400	119,600	139,600	158,800	182,000
~220	22,600	45,200	66,800	87,600	108,400	129,200	150,000	170,800	194,000
~240	24,200	48,400	70,800	93,200	115,600	138,000	160,400	182,800	206,000
~260	27,400	54,800	79,600	105,200	130,800	155,600	181,200	206,000	230,000

※片開きはW300cmまで

style no.60 プレーンシェード

コード式					ドラム式									
H	W	30~45	~90	~140	~190	~240	30~45	~90	~140	~190	~240	~290	~340	~390
50~100	~140	16,900	20,900	32,200	36,000	47,200	19,900	23,900	35,200	39,000	50,200	57,800	69,300	74,100
~180	~220	22,800	26,900	42,200	46,000	61,800	25,800	29,900	45,200	49,000	64,800	72,800	88,200	93,200
~260	~300	28,200	32,400	52,200	56,100	75,700	31,200	35,400	55,200	59,100	78,700	87,400	107,300	112,300
		32,200	36,400	59,100	62,900	85,800	35,200	39,400	62,100	65,900	88,800	97,900	120,200	125,600

※ドラム式：仕上り巾39cm以下の場合、仕上り丈は200cmまでとなります。

style no.63 シャープシェード

コード式					ドラム式									
H	W	30~45	~90	~140	~190	~240	30~45	~90	~140	~190	~240	~290	~340	~390
50~100	~140	19,700	26,000	39,700	46,300	59,600	22,700	29,000	42,700	49,300	62,600	70,800	84,400	91,000
~180	~220	23,000	29,700	45,900	53,000	69,100	26,000	32,700	48,900	56,000	72,100	80,700	96,200	103,100
~260	~300	26,100	33,300	51,600	59,200	78,100	29,100	36,300	54,600	62,200	81,100	90,000	108,300	115,600
		29,400	36,900	57,900	65,900	87,000	32,400	39,900	60,900	68,900	90,000	99,300	119,900	127,600
		32,100	40,300	64,000	72,700	96,600	35,100	43,300	67,000	75,700	99,600	109,400	132,700	140,800
		36,600	45,300	72,300	81,600	109,500	39,600	48,300	75,300	84,600	112,500	122,800	149,200	157,900

※ドラム式：仕上り巾39cm以下の場合、仕上り丈は200cmまでとなります。

形態安定加工 推奨裏地付価格表(推奨裏地TM-54419~54423) 約2倍ヒダ (タッセル含む)

H	W	~44 1巾(片開き)	~100 2巾	~150 3巾	~200 4巾	~250 5巾	~300 6巾	~350 7巾	~400 8巾
~100	19,000	38,000	49,100	66,300	83,500	94,600	111,800	128,300	145,600
~120	21,400	42,800	55,400	74,100	93,700	106,300	125,800	144,600	163,800
~140	23,800	47,500	60,800	82,600	103,900	117,900	139,800	160,900	180,200
~160	26,100	51,400	66,900	90,400	114,700	129,500	153,700	177,200	197,600
~180	28,500	56,100	72,400	99,000	124,800	141,100	167,700	193,600	214,200
~200	30,800	60,800	78,600	106,800	135,000	152,700	181,600	209,900	231,600
~220	32,500	64,800	84,800	115,300	145,900	165,100	195,700	226,200	250,000
~240	34,800	69,500	90,200	123,100	156,000	176,800	209,600	242,500	268,200
~260	38,600	77,100	100,000	136,800	173,500	196,400	233,200	269,200	296,600
~280	41,000	81,100	106,300	144,600	183,700	208,100	247,100	285,600	314,200
約1.5倍ヒダ	~56	~120	~200	~266	~333	~400	~466	~533	

※片開きはW270cmまで

プライム縫製仕様 推奨裏地付価格表(推奨裏地TM-54419~54423) 約2倍ヒダ (タッセル含む)

H	W	~44 1巾(片開き)	~100 2巾	~150 3巾	~200 4巾	~250 5巾	~300 6巾	~350 7巾	~400 8巾
~100	19,800	39,500	50,900	68,800	86,700	98,100	116,000	133,200	150,600
~120	22,300	44,400	57,300	77,000	97,300	110,200	130,500	150,200	168,600
~140	24,700	49,300	63,000	85,800	107,800	122,300	145,100	167,200	186,200
~160	27,100	53,400	69,400	93,900	119,100	134,300	159,600	184,100	202,800
~180	29,600	58,300	75,100	102,700	129,800	146,500	174,200	201,100	218,800
~200	32,000	63,300	81,500	110,900	140,300	158,500	188,600	218,100	234,800
~220	33,700	67,400	87,900	119,700	151,600	171,400	203,200	235,100	250,800
~240	36,200	72,300	93,600	127,900	162,100	183,400	217,700	252,100	266,800
~260	40,200	80,200	103,700	142,100	180,300	203,800	242,200	279,600	292,800
~280	42,600	84,400	110,200	150,200	190,900	216,000	256,600	296,600	308,800
約1.5倍ヒダ	~56	~120	~200	~266	~333	~400	~466	~533	

※片開きはW270cmまで

レギュラー縫製仕様 推奨裏地付価格表(推奨裏地TM-54419~54423) 約2倍ヒダ (タッセル含む)

H	W	~44 1巾(片開き)	~100 2巾	~150 3巾	~200 4巾	~250 5巾	~300 6巾	~350 7巾	~400 8巾
~100	18,300	36,600	47,400	63,900	80,300	91,100	107,600	123,400	139,000
~120	20,600	41,100	53,400	71,400	90,100	102,400	121,000	139,000	154,600
~140	22,800	45,600	58,600	79,500	99,800	113,500	134,500	154,700	170,200
~160	25,100	49,400	64,500	87,000	110,200	124,600	147,800	170,300	185,800
~180	27,400	53,900	69,800	95,200	120,000	135,800			

TM-54099~54103



巾 ◇ 120 cm 価格 ◇ 12,000 円/m リピート ◇ タテ - cm ヨコ - cm
 組成 ◇ ポリエステル100% 寸法変化率 ◇ 水洗い/タテ -0.2% ヨコ -0.2%
 ドライ/タテ 0.0% ヨコ 0.0%

取扱い表示 ◇ リ-30
 防炎性能 ◇ (イ) あて布使用
 Made in Japan

標準仕様		ベルベットフォーマル縫製仕様価格表 約2倍ヒダ (タッセル含む)							
	W	~45 1巾(片開き)	~104 2巾	~162 3巾	~222 4巾	~279 5巾	~342 6巾	~402 7巾	~462 8巾
~100	H	23,200	46,400	66,400	86,600	106,800	127,000	147,200	167,200
~120		26,000	52,000	75,200	98,200	121,200	144,200	167,200	190,400
~140		29,000	57,800	83,800	109,600	135,600	161,600	187,400	213,400
~160		31,800	63,600	92,400	121,200	150,000	178,800	207,600	236,400
~180		34,600	69,400	101,000	132,800	164,400	196,000	227,800	259,400
~200		37,600	75,200	109,600	144,200	178,800	213,400	248,000	282,400
~220		40,400	80,800	118,400	155,800	193,200	230,600	268,000	305,600
~240		43,400	86,600	127,000	167,200	207,600	248,000	288,200	328,600
~260		46,200	92,400	135,600	178,800	222,000	265,200	308,400	351,600
~280		49,000	98,200	144,200	190,400	236,400	282,400	328,600	374,600
約1.5倍ヒダ		~65	~143	~220	~293	~369	~444	~526	~600

バランス		ストレートバランス				
H	W	~100	~150	~200	~250	~300
~40		20,400	29,600	38,800	48,000	57,200
※マジックテープ仕様・裏面スポンジ付の価格になります。 ※ヨコ使いにて縫製した場合の価格になります。						
三つ山・箱ヒダバランス		(約2.5倍ヒダ)				
H	W	~100	~150	~200	~250	~300
~40		17,600	32,500	40,700	50,000	58,200
※マジックテープ仕様の価格になります。						

TM-54104~54112 Cotswold Chenille (コッツウォルド シェニール)



巾 ◇ 150cm 価格 ◇ 9,000円/m リポート ◇ タテ cm ヨコ cm 取扱表示 ◇ リ-30 40 防炎性能 ◇ (イ) 炎 形状記憶 形態安定 デジニデ デジニデ ロールソフト
 組成 ◇ ポリエステル100% 寸法変化率 ◇ 水洗い/タテ -0.7% ヨコ -0.5% ドライ/タテ -1.0% ヨコ -0.5% 防炎性能 ◇ (イ) 炎 形状記憶 形態安定 デジニデ デジニデ ロールソフト
 Made in Japan

H	W	~67 1巾(片開き)	~150 2巾	~225 3巾	~300 4巾	~375 5巾	~450 6巾	~525 7巾
~100		18,000	35,900	51,500	67,000	82,500	98,100	113,600
~120		20,200	40,400	58,100	75,900	93,600	111,400	129,200
~140		22,400	44,800	64,800	84,800	104,700	124,700	144,700
~160		24,600	49,200	71,400	93,600	115,800	138,000	160,200
~180		26,900	53,700	78,100	102,500	126,900	151,400	175,800
~200		29,100	58,100	84,800	111,400	138,000	164,700	191,300
~220		31,300	62,600	91,400	120,300	149,100	178,000	206,900
~240		33,500	67,000	98,100	129,200	160,200	191,300	222,400
~260		35,700	71,400	104,700	138,000	171,300	204,600	237,900
~280		38,000	75,900	111,400	146,900	182,400	218,000	253,500
約1.5倍ヒダ		~88	~200	~300	~400	~500		

※片開きはW270cmまで

H	W	~67 1巾(片開き)	~150 2巾	~225 3巾	~300 4巾	~375 5巾	~450 6巾	~525 7巾
~100		18,400	36,800	52,700	68,700	84,600	100,600	116,600
~120		20,700	41,300	59,600	77,800	96,000	114,300	132,500
~140		23,000	45,900	66,400	86,900	107,400	128,000	148,500
~160		25,200	50,400	73,200	96,000	118,800	141,600	164,400
~180		27,500	55,000	80,100	105,200	130,200	155,300	180,400
~200		29,800	59,600	86,900	114,300	141,600	169,000	196,400
~220		32,100	64,100	93,800	123,400	153,000	182,700	212,300
~240		34,400	68,700	100,600	132,500	164,400	196,400	228,300
~260		36,600	73,200	107,400	141,600	175,800	210,000	244,200
~280		38,900	77,800	114,300	150,800	187,200	223,700	260,200
約1.5倍ヒダ		~88	~200	~300	~400	~500		

※片開きはW270cmまで

H	W	~67 1巾(片開き)	~150 2巾	~225 3巾	~300 4巾	~375 5巾	~450 6巾	~525 7巾	~600 8巾
~100		17,600	35,100	50,200	65,300	80,400	95,600	110,700	125,800
~120		19,700	39,400	56,700	74,000	91,200	108,500	125,800	143,100
~140		21,900	43,700	63,200	82,600	102,000	121,500	140,900	160,400
~160		24,000	48,000	69,600	91,200	112,800	134,400	156,000	177,600
~180		26,200	52,400	76,100	99,900	123,600	147,400	171,200	194,900
~200		28,400	56,700	82,600	108,500	134,400	160,400	186,300	212,200
~220		30,500	61,000	89,100	117,200	145,200	173,300	201,400	229,500
~240		32,700	65,300	95,600	125,800	156,000	186,300	216,500	246,800
~260		34,800	69,600	102,000	134,400	166,800	199,200	231,600	264,000
~280		37,000	74,000	108,500	143,100	177,600	212,200	246,800	281,300
約1.5倍ヒダ		~88	~200	~300	~400	~500	~600	~700	~800
フラット前1倍ヒダ		~130	~260	~410	~560				

H	W	~67 1巾(片開き)	~150 2巾	~225 3巾	~300 4巾	~375 5巾	~450 6巾	~525 7巾	~600 8巾
~100		19,200	38,400	55,200	72,000	88,800	105,600	122,400	139,200
~120		21,600	43,200	62,400	81,600	100,800	120,000	139,200	158,400
~140		24,000	48,000	69,600	91,200	112,800	134,400	156,000	177,600
~160		26,400	52,800	76,800	100,800	124,800	148,800	172,800	196,800
~180		28,800	57,600	84,000	110,400	136,800	163,200	189,600	216,000
~200		31,200	62,400	91,200	120,000	148,800	177,600	206,400	235,200
~220		33,600	67,200	98,400	129,600	160,800	192,000	223,200	254,400
~240		36,000	72,000	105,600	139,200	172,800	206,400	240,000	273,600
~260		38,400	76,800	112,800	148,800	184,800	220,800	256,800	292,800

※片開きはW300cmまで

		コード式				ドラム式								
H	W	30~45	~90	~140	~190	~240	30~45	~90	~140	~190	~240	~290	~340	~390
50~100		19,600	23,500	28,000	41,100	45,700	22,600	26,500	31,000	44,100	48,700	56,200	70,300	75,100
~140		23,600	27,500	32,300	48,300	53,300	26,600	30,500	35,300	51,300	56,300	64,100	81,400	86,300
~180		27,600	31,500	36,500	55,600	60,700	30,600	34,500	39,500	58,600	63,700	71,800	92,300	97,300
~220		31,600	35,600	40,800	62,900	68,200	34,600	38,600	43,800	65,900	71,200	79,700	103,400	108,500
~260		35,600	39,600	45,000	70,200	75,700	38,600	42,600	48,000	73,200	78,700	87,400	114,500	119,500
~300		39,600	43,600	49,300	77,500	83,300	42,600	46,600	52,300	80,500	86,300	95,300	125,400	130,700

※ドラム式: 仕上り巾39cm以下の場合、仕上り丈は200cmまでとなります。

		コード式	
H	W	18~30	30~39
50~100		23,700	28,100
~140		28,100	31,900
~180		31,900	36,300
~220		36,300	38,800
~240		38,800	

		コード式				ドラム式								
H	W	30~45	~90	~140	~190	~240	30~45	~90	~140	~190	~240	~290	~340	~390
50~100		22,400	28,700	35,300	51,700	58,000	25,400	31,700	38,300	54,700	61,000	69,200	85,500	92,100
~140		26,700	33,400	40,500	60,500	67,500	29,700	36,400	43,500	63,500	70,500	79,100	98,900	105,800
~180		31,000	38,100	45,700	69,500	77,000	34,000	41,100	48,700	72,500	80,000	88,900	112,600	119,900
~220		35,300	42,900	50,900	78,300	86,500	38,300	45,900	53,900	81,300	89,500	98,700	125,800	133,500
~260		39,700	47,800	56,500	87,800	96,600	42,700	50,800	59,500	90,800	99,600	109,400	140,200	148,400
~300		44,100	52,800	62,100	97,200	106,800	47,100	55,800	65,100	100,200	109,800	120,100	154,600	163,300

※ドラム式: 仕上り巾39cm以下の場合、仕上り丈は200cmまでとなります。

		(片開き/タッセルなし)						
H	W	~72	~100	~127	~155	~183	~211	~238
~100		20,200	34,100	38,300	40,400	54,200		
~140		23,600	40,800	45,000	47,100	64,300		
~180		26,900	47,500	51,700	53,800	74,400		
~220		30,300	54,200	58,400	60,500	84,500		
~260		33,600	60,900	65,100	67,200	94,500		
~300		37,000	67,700	71,900	74,000	104,600		
26mm		-2,800	-2,100	-4,900	-4,200	-4,900		
18mm		-4,900	-5,600	-9,100	-9,800	-10,500		

※生地を伸ばした状態のサイズでご発注ください。

		スプリング・チェーンタイプ				
H	W	30~60	~80	~100	~120	~140
50~80		34,500	37,000	39,000	40,200	41,900
~120		38,500	41,600	43,600	44,700	46,600
~160		42,400	46,200	48,200	49,400	50,700
~200		47,500	50,500	52,700	53,900	55,200
~240			55,000	57,300	58,500	59,900

※丈は巾の3倍までが限度です。
 ※ロールソフト加工品は非防炎品になります。

		ストレートバランス				
H	W	~100	~150	~200	~250	~300
~40		13,200	21,900	26,300	30,700	39,400

※マジックテープ仕様・裏面スポンジ付の価格になります。

H	W	~100	~150	~200	~250	~300
~40		14,200	20,800	27,300	34,800	36,300

※マジックテープ仕様・裏面スポンジ付の価格になります。

プレーン		パイピング	
サイズ	価格	サイズ	価格
40x40	8,200	40x40	9,500
45x45	9,600	45x45	10,900
フリル付			
サイズ	価格	サイズ	価格
40x40	14,700	40x40	14,000
45x45	16,800	45x45	16,100

※中材込みの価格になります。

プレーン

CP06 サイドボーダースタイル (形態安定加工)

(約2倍ヒダ/タッセル含む)

H	W	~150	~225	~300	~375	~450
~120		60,600	87,200	113,900	140,400	167,100
~140		67,200	97,200	127,200	157,100	187,100
~160		73,800	107,100	140,400	173,700	207,000
~180		80,600	117,200	153,800	190,400	227,100
~200		87,200	127,200	167,100	207,000	247,100
~220		93,900	137,100	180,500	223,700	267,000
~240		100,500	147,200	193,800	240,300	287,000
~260		107,100	157,100	207,000	257,000	306,900
約1.5倍ヒダ		~200	~300	~400	~500	

※片開きはW270cmまで

ギャザーカーテントップボーダー (形態安定加工)

(約2倍ヒダ/タッセル含む)

H	W	~150	~225	~300	~375	~450
~120		101,000	145,300	189,800	234,000	278,500
~140		112,000	162,000	212,000	261,800	311,800
~160		123,000	178,500	234,000	289,500	345,000
~180		134,300	195,300	256,300	317,300	378,500
~200		145,300	212,000	278,500	345,000	411,800
~220		156,500	228,500	300,800	372,800	445,000
~240		167,500	245,300	323,000	400,500	478,300
~260		178,500	261,800	345,000	428,300	511,500
約1.5倍ヒダ		~200	~300	~400	~500	

※片開きはW270cmまで

ボトムボーダーフレンジ付 (形態安定加工)

(約2倍ヒダ/タッセル含む)

H	W	~150	~225	~300	~375	~450
~120		80,800	116,200	151,800	187,200	222,800
~140		89,600	129,600	169,600	209,400	249,400
~160		98,400	142,800	187,200	231,600	276,000
~180		107,400	156,200	205,000	253,800	302,800
~200		116,200	169,600	222,800	276,000	329,400
~220		125,200	182,800	240,600	298,200	356,000
~240		134,000	196,200	258,400	320,400	382,600
~260		142,800	209,400	276,000	342,600	409,200
約1.5倍ヒダ		~200	~300	~400	~500	

※片開きはW270cmまで

ウイングシェードフレンジ付

		コード式				ドラム式						
		1S	2S	3S		1S	2S	3S	4S			
H	W	100	~150	~200	~250	100	~150	~200	~250	~300	~350	~400
100~140		54,600	84,900	96,300	129,300	57,600	87,900	99,300	132,300	146,600	179,400	193,500
~180		62,900	98,900	111,600	150,600	65,900	101,900	114,600	153,600	169,100	208,100	223,800
~220		71,300	113,000	126,800	171,900	74,300	116,000	129,800	174,900	191,700	236,900	254,100
~260		79,700	127,100	142,100	193,200	82,700	130,100	145,100	196,200	214,400	265,500	278,600
~300		88,100	141,000	157,200	214,500	91,100	144,000	160,200	217,500	237,000	294,300	314,700

TM-54113~54124 Exeter (エクセター)



巾 ◇ 150 cm 価格 ◇ 5,700 円/m リポート ◇ タテ cm ヨコ cm 取扱い表示 ◇ リ-30 40 50 60 70 80 90 100 110 120 130 140 150 160 170 180 190 200 210 220 230 240 250 260 270 280 290 300 310 320 330 340 350 360 370 380 390 400 410 420 430 440 450 460 470 480 490 500 510 520 530 540 550 560 570 580 590 600 610 620 630 640 650 660 670 680 690 700 710 720 730 740 750 760 770 780 790 800 810 820 830 840 850 860 870 880 890 900 910 920 930 940 950 960 970 980 990 1000
 組成 ◇ ポリエステル100% 寸法変化率 ◇ 水洗い/タテ -0.3% ヨコ 0.0% 防炎性能 ◇ (イ) 乾燥/タテ -0.5% ヨコ -0.2% Made in Japan

H	W	~67 1巾(片開き)	~150 2巾	~225 3巾	~300 4巾	~375 5巾	~450 6巾	~525 7巾
~100	12,700	25,400	36,300	47,200	58,100	69,000	80,000	
~120	14,300	28,500	41,000	53,400	65,900	78,400	90,900	
~140	15,800	31,600	45,600	59,700	73,700	87,800	101,800	
~160	17,400	34,700	50,300	65,900	81,500	97,100	112,700	
~180	18,900	37,800	55,000	72,200	89,300	106,500	123,600	
~200	20,500	41,000	59,700	78,400	97,100	115,800	134,600	
~220	22,100	44,100	64,400	84,600	104,900	125,200	145,500	
~240	23,600	47,200	69,000	90,900	112,700	134,600	156,400	
~260	25,200	50,300	73,700	97,100	120,500	143,900	167,300	
~280	26,700	53,400	78,400	103,400	128,300	153,300	178,200	
約1.5倍ヒダ	~88	~200	~300	~400	~500			

※片開きはW270cmまで

H	W	~67 1巾(片開き)	~150 2巾	~225 3巾	~300 4巾	~375 5巾	~450 6巾	~525 7巾
~100	13,100	26,200	37,500	48,900	60,200	71,600	82,900	
~120	14,700	29,400	42,400	55,400	68,300	81,300	94,200	
~140	16,400	32,700	47,300	61,800	76,400	91,000	105,600	
~160	18,000	35,900	52,100	68,300	84,500	100,700	116,900	
~180	19,600	39,200	57,000	74,800	92,600	110,400	128,300	
~200	21,200	42,400	61,800	81,300	100,700	120,200	139,600	
~220	22,800	45,600	66,700	87,800	108,800	129,900	150,900	
~240	24,500	48,900	71,600	94,200	116,900	139,600	162,300	
~260	26,100	52,100	76,400	100,700	125,000	149,300	173,600	
~280	27,700	55,400	81,300	107,200	133,100	159,000	185,000	
約1.5倍ヒダ	~88	~200	~300	~400	~500			

※片開きはW270cmまで

H	W	~67 1巾(片開き)	~150 2巾	~225 3巾	~300 4巾	~375 5巾	~450 6巾	~525 7巾	~600 8巾
~100	12,300	24,500	35,000	45,500	56,000	66,500	77,000	87,500	
~120	13,800	27,500	39,500	51,500	63,500	75,500	87,500	99,500	
~140	15,300	30,500	44,000	57,500	71,000	84,500	98,000	111,500	
~160	16,800	33,500	48,500	63,500	78,500	93,500	108,500	123,500	
~180	18,300	36,500	53,000	69,500	86,000	102,500	119,000	135,500	
~200	19,800	39,500	57,500	75,500	93,500	111,500	129,500	147,500	
~220	21,300	42,500	62,000	81,500	101,000	120,500	140,000	159,500	
~240	22,800	45,500	66,500	87,500	108,500	129,500	150,500	171,500	
~260	24,300	48,500	71,000	93,500	116,000	138,500	161,000	183,500	
~280	25,800	51,500	75,500	99,500	123,500	147,500	171,500	195,500	
約1.5倍ヒダ	~88	~200	~300	~400	~500	~600	~700	~800	
フラット約1倍ヒダ	~130	~260	~410	~560					

H	W	~67 1巾(片開き)	~150 2巾	~225 3巾	~300 4巾	~375 5巾	~450 6巾	~525 7巾	~600 8巾
~100	14,000	27,900	40,100	52,200	64,400	76,600	88,800	101,000	
~120	15,700	31,400	45,300	59,200	73,100	87,000	101,000	114,900	
~140	17,400	34,800	50,500	66,200	81,800	97,500	113,100	128,800	
~160	19,200	38,300	55,700	73,100	90,500	107,900	125,300	142,700	
~180	20,900	41,800	60,900	80,100	99,200	118,400	137,500	156,600	
~200	22,700	45,300	66,200	87,000	107,900	128,800	149,700	170,600	
~220	24,400	48,800	71,400	94,000	116,600	139,200	161,900	184,500	
~240	26,100	52,200	76,600	101,000	125,300	149,700	174,000	198,400	
~260	27,900	55,700	81,800	107,900	134,000	160,100	186,200	212,300	

※片開きはW300cmまで

H	W	コード式					ドラム式							
		30~45	~90	~140	~190	~240	30~45	~90	~140	~190	~240	~290	~340	~390
50~100	16,100	20,100	24,600	34,400	39,100	19,100	23,100	27,600	37,400	42,100	49,400	60,100	64,900	
~140	18,900	23,000	27,700	39,500	44,400	21,900	26,000	30,700	42,500	47,400	55,100	67,800	72,700	
~180	21,800	25,800	30,800	44,500	49,700	24,800	28,800	33,800	47,500	52,700	60,500	75,300	80,300	
~220	24,700	28,800	34,000	49,600	54,900	27,700	31,800	37,000	52,600	57,900	66,100	82,900	88,100	
~260	27,500	31,600	37,100	54,700	60,200	30,500	34,600	40,100	57,700	63,200	71,500	90,700	95,700	
~300	30,300	34,600	40,200	59,700	65,500	33,300	37,600	43,200	62,700	68,500	77,100	98,100	103,500	

※ドラム式: 仕上り巾39cm以下の場合、仕上り丈は200cmまでとなります。

H	W	コード式					ドラム式							
		30~45	~90	~140	~190	~240	30~45	~90	~140	~190	~240	~290	~340	~390
50~100	18,900	25,200	31,800	44,500	50,900	21,900	28,200	34,800	47,500	53,900	62,100	74,800	81,400	
~140	22,000	28,700	35,800	51,000	58,000	25,000	31,700	38,800	54,000	61,000	69,600	84,700	91,500	
~180	25,100	32,200	39,700	57,600	65,100	28,100	35,200	42,700	60,600	68,000	77,000	94,800	102,100	
~220	28,200	35,700	43,800	64,100	72,200	31,200	38,700	46,800	67,100	75,200	84,500	104,500	112,100	
~260	31,400	39,500	48,200	71,200	80,000	34,400	42,500	51,200	74,200	83,000	92,800	115,300	123,400	
~300	34,600	43,300	52,600	78,200	87,800	37,600	46,300	55,600	81,200	90,800	101,000	126,100	134,800	

※ドラム式: 仕上り巾39cm以下の場合、仕上り丈は200cmまでとなります。

H	W	~67 1巾(片開き)	~150 2巾	~225 3巾	~300 4巾	~375 5巾	~450 6巾	~525 7巾
~100	18,800	37,600	54,600	71,600	88,600	105,600	122,700	
~120	21,300	42,500	61,900	81,300	100,700	120,200	139,600	
~140	23,700	47,300	69,100	91,100	112,900	134,800	156,700	
~160	26,100	52,100	76,400	100,700	125,000	149,300	173,600	
~180	28,500	57,000	83,800	110,500	137,200	164,000	190,600	
~200	31,000	61,900	91,100	120,200	149,300	178,500	207,700	
~220	33,500	66,800	98,400	129,900	161,500	193,100	224,700	
~240	35,800	71,600	105,600	139,700	173,600	207,700	241,700	
~260	38,300	76,400	112,900	149,300	185,800	222,200	258,700	
~280	40,700	81,300	120,200	159,100	197,900	236,900	275,700	
約1.5倍ヒダ	~88	~200	~300	~400	~500			

※片開きはW270cmまで

H	W	~67 1巾(片開き)	~150 2巾	~225 3巾	~300 4巾	~375 5巾	~450 6巾	~525 7巾
~100	19,700	39,300	57,100	75,000	92,800	110,700	128,500	
~120	22,200	44,300	64,800	85,200	105,500	126,000	146,300	
~140	24,800	49,500	72,500	95,300	118,300	141,300	164,200	
~160	27,300	54,500	80,000	105,500	131,000	156,500	182,000	
~180	29,900	59,700	87,700	115,800	143,800	171,800	200,000	
~200	32,400	64,800	95,300	126,000	156,500	187,200	217,800	
~220	34,900	69,800	103,000	136,200	169,300	202,500	235,600	
~240	37,600	75,000	110,700	146,300	182,000	217,800	253,500	
~260	40,100	80,000	118,300	156,500	194,800	233,000	271,300	
~280	42,600	85,200	126,000	166,800	207,500	248,300	289,200	
約1.5倍ヒダ	~88	~200	~300	~400	~500			

※片開きはW270cmまで

H	W	~67 1巾(片開き)	~150 2巾	~225 3巾	~300 4巾	~375 5巾	~450 6巾	~525 7巾	~600 8巾
~100	18,000	35,900	52,100	68,200	84,400	100,600	116,700	132,900	
~120	20,300	40,500	59,000	77,500	95,900	114,400	132,900	151,400	
~140	22,600	45,100	65,900	86,700	107,500	128,300	149,100	169,900	
~160	24,900	49,700	72,800	95,900	119,000	142,100	165,200	188,300	
~180	27,300	54,400	79,800	105,200	130,600	156,000	181,400	206,800	
~200	29,600	59,000	86,700	114,400	142,100	169,900	197,600	225,300	
~220	31,900	63,600	93,600	123,700	153,700	183,700	213,800	243,800	
~240	34,200	68,200	100,600	132,900	165,200	197,600	229,900	262,300	
~260	36,500	72,800	107,500	142,100					

クッション

クッション		
プレーン	パイピング	
サイズ	40×40	45×45
	6,900	8,300
フリル付	フレーム付	
サイズ	40×40	45×45
	11,500	13,400

※中材込みの価格になります。

CP05 ボトムボードスタイル (形態安定加工)

CP05 ボトムボードスタイル (形態安定加工)					
(約2倍ヒダ/タッセル含む)					
H	W	~150	~225	~300	~375 ~450
~120		42,800	61,500	80,100	98,900 117,600
~140		47,400	68,400	89,600	110,600 131,700
~160		52,100	75,500	98,900	122,300 145,700
~180		56,700	82,500	108,300	134,000 159,800
~200		61,500	89,600	117,600	145,700 173,700
~220		66,200	96,600	126,900	157,400 187,800
~240		70,800	103,500	136,400	169,100 201,900
~260		75,500	110,600	145,700	180,800 215,900
約1.5倍ヒダ		~200	~300	~400	~500

※片開きはW270cmまで

TM-54129~54134



巾 ◇ 150cm 価格 ◇ 5,100円/m リピート ◇ タテ cm ヨコ cm 取扱い表示 ◇ リ-30
 組成 ◇ ポリエステル100% 寸法変化率 ◇ 水洗い/タテ -0.5% ヨコ 0.0% 防炎性能 ◇ (イ) であて布使用
 ドライ/タテ -0.7% ヨコ 0.0% Made in Japan

H	W	~67 1巾(片開き)	~150 2巾	~225 3巾	~300 4巾	~375 5巾	~450 6巾	~525 7巾
~100		11,700	23,400	33,500	43,600	53,700	63,800	73,800
~120		13,200	26,300	37,800	49,400	60,900	72,400	83,900
~140		14,600	29,200	42,200	55,100	68,100	81,000	94,000
~160		16,100	32,100	46,500	60,900	75,300	89,700	104,100
~180		17,500	35,000	50,800	66,600	82,500	98,300	114,200
~200		18,900	37,800	55,100	72,400	89,700	107,000	124,200
~220		20,400	40,700	59,400	78,200	96,900	115,600	134,300
~240		21,800	43,600	63,800	83,900	104,100	124,200	144,400
~260		23,300	46,500	68,100	89,700	111,300	132,900	154,500
~280		24,700	49,400	72,400	95,400	118,500	141,500	164,600
約1.5倍ヒダ		~88	~200	~300	~400	~500		

※片開きはW270cmまで

H	W	~67 1巾(片開き)	~150 2巾	~225 3巾	~300 4巾	~375 5巾	~450 6巾	~525 7巾
~100		12,200	24,300	34,800	45,300	55,800	66,300	76,800
~120		13,700	27,300	39,300	51,300	63,300	75,300	87,300
~140		15,200	30,300	43,800	57,300	70,800	84,300	97,800
~160		16,700	33,300	48,300	63,300	78,300	93,300	108,300
~180		18,200	36,300	52,800	69,300	85,800	102,300	118,800
~200		19,700	39,300	57,300	75,300	93,300	111,300	129,300
~220		21,200	42,300	61,800	81,300	100,800	120,300	139,800
~240		22,700	45,300	66,300	87,300	108,300	129,300	150,300
~260		24,200	48,300	70,800	93,300	115,800	138,300	160,800
~280		25,700	51,300	75,300	99,300	123,300	147,300	171,300
約1.5倍ヒダ		~88	~200	~300	~400	~500		

※片開きはW270cmまで

H	W	~67 1巾(片開き)	~150 2巾	~225 3巾	~300 4巾	~375 5巾	~450 6巾	~525 7巾	~600 8巾
~100		11,300	22,600	32,300	41,900	51,600	61,200	70,900	80,600
~120		12,700	25,400	36,400	47,400	58,500	69,500	80,600	91,600
~140		14,100	28,100	40,500	53,000	65,400	77,800	90,200	102,600
~160		15,500	30,900	44,700	58,500	72,300	86,100	99,900	113,700
~180		16,800	33,600	48,800	64,000	79,200	94,400	109,500	124,700
~200		18,200	36,400	53,000	69,500	86,100	102,600	119,200	135,800
~220		19,600	39,200	57,100	75,000	93,000	110,900	128,900	146,800
~240		21,000	41,900	61,200	80,600	99,900	119,200	138,500	157,800
~260		22,400	44,700	65,400	86,100	106,800	127,500	148,200	168,900
~280		23,700	47,400	69,500	91,600	113,700	135,800	157,800	179,900
約1.5倍ヒダ		~88	~200	~300	~400	~500	~600	~700	~800
フラット前ヒダ		~130	~260	~410	~560				

H	W	~67 1巾(片開き)	~150 2巾	~225 3巾	~300 4巾	~375 5巾	~450 6巾	~525 7巾	~600 8巾
~100		13,000	26,000	37,300	48,600	60,000	71,300	82,700	94,000
~120		14,600	29,200	42,200	55,100	68,100	81,000	94,000	107,000
~140		16,200	32,400	47,000	61,600	76,200	90,800	105,300	119,900
~160		17,900	35,700	51,900	68,100	84,300	100,500	116,700	132,900
~180		19,500	38,900	56,700	74,600	92,400	110,200	128,000	145,800
~200		21,100	42,200	61,600	81,000	100,500	119,900	139,400	158,800
~220		22,700	45,400	66,500	87,500	108,600	129,600	150,700	171,800
~240		24,300	48,600	71,300	94,000	116,700	139,400	162,000	184,700
~260		26,000	51,900	76,200	100,500	124,800	149,100	173,400	197,700

※片開きはW300cmまで

H	W	コード式				ドラム式								
		30~45	~90	~140	~240	30~45	~90	~140	~190	~240	~290	~340	~390	
50~100		15,400	19,400	24,000	33,200	37,900	18,400	22,400	27,000	36,200	40,900	48,200	58,200	63,000
~140		18,100	22,200	26,900	37,900	42,800	21,100	25,200	29,900	40,900	45,800	53,400	65,300	70,200
~180		20,700	24,800	29,800	42,500	47,600	23,700	27,800	32,800	45,500	50,600	58,400	72,200	77,200
~220		23,400	27,500	32,700	47,200	52,500	26,400	30,500	35,700	50,200	55,500	63,600	79,200	84,400
~260		26,000	30,200	35,600	51,800	57,400	29,000	33,200	38,600	54,800	60,400	68,600	86,300	91,300
~300		28,600	32,900	38,500	56,500	62,300	31,600	35,900	41,500	59,500	65,300	73,800	93,200	98,500

※ドラム式：仕上り巾39cm以下の場合、仕上り丈は200cmまでとなります。

H	W	コード式
50~100		18~30
~140		19,900
~180		23,100
~220		25,700
~240		28,800
~240		30,700

スプリング・チェーンタイプ						
H	W	30~60	~80	~100	~120	~140
50~80		30,700	33,200	35,200	36,400	38,100
~120		33,500	36,600	38,600	39,700	41,600
~160		36,200	40,000	42,000	43,200	44,500
~200		40,000	43,000	45,200	46,400	47,700
~240			46,300	48,600	49,800	51,200

※丈は巾の3倍までが限度です。
 ※ロールソフト加工品は非防炎品になります。

プレーン

TM-54135~54146



巾 ◇ 150cm 価格 ◇ 4,500円/m リポート ◇ タテ cm ヨコ cm 取扱表示 ◇ リ-30 40 防炎性能 ◇ (イ) 防水/タテ -0.8% ヨコ 0.0% ドライ/タテ -0.7% ヨコ -0.7% Made in Japan

H	W	~67 1巾(片開き)	~150 2巾	~225 3巾	~300 4巾	~375 5巾	~450 6巾	~525 7巾
~100		10,800	21,500	30,800	40,000	49,200	58,500	67,700
~120		12,100	24,200	34,700	45,300	55,800	66,400	77,000
~140		13,400	26,800	38,700	50,600	62,400	74,300	86,200
~160		14,700	29,400	42,600	55,800	69,000	82,200	95,400
~180		16,100	32,100	46,600	61,100	75,600	90,200	104,700
~200		17,400	34,700	50,600	66,400	82,200	98,100	113,900
~220		18,700	37,400	54,500	71,700	88,800	106,000	123,200
~240		20,000	40,000	58,500	77,000	95,400	113,900	132,400
~260		21,300	42,600	62,400	82,200	102,000	121,800	141,600
~280		22,700	45,300	66,400	87,500	108,600	129,800	150,900
約1.5倍ヒダ		~88	~200	~300	~400	~500		

※片開きはW270cmまで

H	W	~67 1巾(片開き)	~150 2巾	~225 3巾	~300 4巾	~375 5巾	~450 6巾	~525 7巾
~100		11,200	22,400	32,000	41,700	51,300	61,000	70,700
~120		12,600	25,100	36,200	47,200	58,200	69,300	80,300
~140		14,000	27,900	40,300	52,700	65,100	77,600	90,000
~160		15,300	30,600	44,400	58,200	72,000	85,800	99,600
~180		16,700	33,400	48,600	63,800	78,900	94,100	109,300
~200		18,100	36,200	52,700	69,300	85,800	102,400	119,000
~220		19,500	39,000	56,900	74,800	92,700	110,700	128,600
~240		20,900	41,700	61,000	80,300	99,600	119,000	138,300
~260		22,200	44,400	65,100	85,800	106,500	127,200	147,900
~280		23,600	47,200	69,300	91,400	113,400	135,500	157,600
約1.5倍ヒダ		~88	~200	~300	~400	~500		

※片開きはW270cmまで

H	W	~67 1巾(片開き)	~150 2巾	~225 3巾	~300 4巾	~375 5巾	~450 6巾	~525 7巾	~600 8巾
~100		10,400	20,700	29,500	38,300	47,100	56,000	64,800	73,600
~120		11,600	23,200	33,300	43,400	53,400	63,500	73,600	83,700
~140		12,900	25,700	37,100	48,400	59,700	71,100	82,400	93,800
~160		14,100	28,200	40,800	53,400	66,000	78,600	91,200	103,800
~180		15,400	30,800	44,600	58,500	72,300	86,200	100,100	113,900
~200		16,700	33,300	48,400	63,500	78,600	93,800	108,900	124,000
~220		17,900	35,800	52,200	68,600	84,900	101,300	117,700	134,100
~240		19,200	38,300	56,000	73,600	91,200	108,900	126,500	144,200
~260		20,400	40,800	59,700	78,600	97,500	116,400	135,300	154,200
~280		21,700	43,400	63,500	83,700	103,800	124,000	144,200	164,300
約1.5倍ヒダ		~88	~200	~300	~400	~500	~600	~700	~800
フラット前1倍ヒダ		~130	~260	~410	~560				

H	W	~67 1巾(片開き)	~150 2巾	~225 3巾	~300 4巾	~375 5巾	~450 6巾	~525 7巾	~600 8巾
~100		12,000	24,000	34,500	45,000	55,500	66,000	76,500	87,000
~120		13,500	27,000	39,000	51,000	63,000	75,000	87,000	99,000
~140		15,000	30,000	43,500	57,000	70,500	84,000	97,500	111,000
~160		16,500	33,000	48,000	63,000	78,000	93,000	108,000	123,000
~180		18,000	36,000	52,500	69,000	85,500	102,000	118,500	135,000
~200		19,500	39,000	57,000	75,000	93,000	111,000	129,000	147,000
~220		21,000	42,000	61,500	81,000	100,500	120,000	139,500	159,000
~240		22,500	45,000	66,000	87,000	108,000	129,000	150,000	171,000
~260		24,000	48,000	70,500	93,000	115,500	138,000	160,500	183,000

※片開きはW300cmまで

H	W	コード式				ドラム式								
		30~45	~90	~140	~240	30~45	~90	~140	~190	~240	~290	~340	~390	
50~100		14,800	18,800	23,400	32,000	36,700	17,800	21,800	26,400	35,000	39,700	46,900	56,400	61,200
~140		17,300	21,300	26,100	36,200	41,200	20,300	24,300	29,100	39,200	44,200	51,700	62,800	67,700
~180		19,700	23,800	28,800	40,500	45,600	22,700	26,800	31,800	43,500	48,600	56,300	69,100	74,100
~220		22,100	26,300	31,500	44,800	50,100	25,100	29,300	34,500	47,800	53,100	61,100	75,500	80,600
~260		24,500	28,800	34,200	49,000	54,500	27,500	31,800	37,200	52,000	57,500	65,700	82,000	87,000
~300		27,000	31,300	36,900	53,300	59,100	30,000	34,300	39,900	56,300	62,100	70,500	88,200	93,600

※ドラム式：仕上り巾39cm以下の場合、仕上り丈は200cmまでとなります。

H	W	コード式
50~100		18~30
~140		19,400
~180		22,300
~220		24,700
~240		27,700
~260		29,400

H	W	コード式				ドラム式								
		30~45	~90	~140	~240	30~45	~90	~140	~190	~240	~290	~340	~390	
50~100		17,600	23,900	30,500	41,900	48,300	20,600	26,900	33,500	44,900	51,300	59,500	70,900	77,500
~140		20,300	27,000	34,100	47,600	54,600	23,300	30,000	37,100	50,600	57,600	66,100	79,500	86,400
~180		22,900	30,000	37,600	53,300	60,800	25,900	33,000	40,600	56,300	63,800	72,700	88,300	95,600
~220		25,600	33,100	41,200	58,900	67,000	28,600	36,100	44,200	61,900	70,000	79,300	96,700	104,300
~260		28,300	36,500	45,100	65,100	74,000	31,300	39,500	48,100	68,100	77,000	86,700	106,200	114,400
~300		31,200	39,900	49,100	71,300	80,900	34,200	42,900	52,100	74,300	83,900	94,100	115,700	124,400

※ドラム式：仕上り巾39cm以下の場合、仕上り丈は200cmまでとなります。

H	W	38mm	26mm	18mm
~72		~100	~127	~155
~100		15,200	24,000	30,300
~140		17,100	27,800	34,100
~180		19,000	31,700	38,000
~220		20,900	35,500	41,800
~260		22,800	39,300	45,600
~300		24,800	43,200	49,500
26mm		-2,800	-2,100	-4,900
18mm		-4,900	-5,600	-9,100

※生地を伸ばした状態のサイズでご発注ください。

H	W	スプリング・チェーンタイプ			
		30~60	~80	~100	~120
50~80		30,200	32,700	34,700	35,900
~120		32,700	35,800	37,800	40,800
~160		35,200	39,000	41,000	42,200
~200		38,900	41,900	44,100	46,600
~240		44,900	47,200	48,400	49,800

※丈は巾の3倍までが限度です。
※ロールソフト加工品は非防炎品になります。

ストレートバランス				
H	W	~100	~150	~200
~40		13,200	19,400	25,600
~100		31,800	38,000	

H	W	~100	~150	~200	~250	~300
~40		9,200	13,200	17,200	22,200	23,700

※マジックテープ仕様の価格になります。

プレーン		パイピング	
サイズ	価格	サイズ	価格
40x40	6,400	40x40	7,300
45x45	7,800	45x45	8,700
フリル付			
サイズ	価格	サイズ	価格
40x40	10,400	40x40	10,000
45x45	12,100	45x45	11,800

※中材込みの価格になります。

プレーン

CP01 バイアスボーダースタイル (形態安定加工)

(約2倍ヒダ/タッセル含む)

H	W	~150	~225	~300	~375	~450
~120		36,300	52,100	68,000	83,700	99,600
~140		40,200	58,100	75,900	93,600	111,500
~160		44,100	63,900	83,700	103,500	123,300
~180		48,200	69,900	91,700	113,400	135,300
~200		52,100	75,900	99,600	123,300	147,200
~220		56,100	81,800	107,600	133,200	159,000
~240		60,000	87,800	115,500	143,100	170,900
~260		63,900	93,600	123,300	153,000	182,700
約1.5倍ヒダ		~200	~300	~400	~500	

※片開きはW270cmまで

CP02 スリムボーダースタイル (形態安定加工)

(約2倍ヒダ/タッセル含む)

H	W	~150	~225	~300	~375	~450
~120		36,300	52,100	68,000	83,700	99,600
~140		40,200	58,100	75,900	93,600	111,500
~160		44,100	63,900	83,700	103,500	123,300
~180		48,200	69,900	91,700	113,400	135,300
~200		52,100	75,900	99,600	123,300	147,200
~220		56,100	81,800	107,600	133,200	159,000
~240		60,000	87,800	115,500	143,100	170,900
~260		63,900	93,600	123,300	153,000	182,700
約1.5倍ヒダ		~200	~300	~400	~500	

※片開きはW270cmまで

CP03 ミックスボーダースタイル (形態安定加工)

(約2倍ヒダ/タッセル含む)

H	W	~150	~225	~300	~375	~450
~120		36,300	52,100	68,000	83,700	99,600
~140		40,200	58,100	75,900	93,600	111,500
~160		44,100	63,900	83,700	103,500	123,300
~180		48,200	69,900	91,700	113,400	135,300
~200		52,100	75,900	99,600	123,300	147,200
~220		56,100	81,800	107,600	133,200	159,000
~240		60,000	87,800	115,500	143,100	170,900
~260		63,900	93,600	123,300	153,000	182,700
約1.5倍ヒダ		~200	~300	~400	~500	

※片開きはW270cmまで

CP04 トップボーダースタイル (形態安定加工)

(約2倍ヒダ/タッセル含む)

H	W	~150	~225	~300	~375	~450
~120		36,300	52,100	68,000	83,700	99,600
~140		40,200	58,100	75,900	93,600	111,500
~160		44,100	63,900	83,700	103,500	123,300
~180		48,200	69,900	91,700	113,400	135,300
~200		52,100	75,900	99,600	123,300	147,200
~220		56,100	81,800	107,600	133,200	159,000
~240		60,000	87,800	115,500	143,100	170,900
~260		63,900	93,600	123,300	153,000	182,700
約1.5倍ヒダ		~200	~300	~400	~500	

※片開きはW270cmまで

CP05 ボトムボーダースタイル (形態安定加工)

(約2倍ヒダ/タッセル含む)

H	W	~150	~225	~300	~375	~450
~120		36,300	52,100	68,000	83,700	99,600
~140		40,200	58,100	75,900	93,600	111,500
~160		44,100	63,900	83,700	103,500	123,300
~180		48,200	69,900	91,700	113,400	135,300
~200		52,100	75,900	99,600	123,300	147,200
~220		56,100	81,800	107,600	133,200	159,000
~240		60,000	87,800	115,500	143,100	170,900
~260		63,900	93,600	123,300	153,000	182,700
約1.5倍ヒダ		~200	~300	~400	~500	

※片開きはW270cmまで

CP06 サイドボーダースタイル (形態安定加工)

(約2倍ヒダ/タッセル含む)

H	W	~150	~225	~300	~375	~450
~120		36,300	52,100	68,000	83,700	99,600
~140		40,200	58,100	75,900	93,600	111,500
~160		44,100	63,900	83,700	103,500	123,300
~180		48,200	69,900	91,700	113,400	135,300
~200		52,100	75,900	99,600	123,300	147,200
~220		56,100	81,800	107,600	133,200	159,000
~240		60,000	87,800	115,500	143,100	170,900
~260		63,900	93,600	123,300	153,000	182,700
約1.5倍ヒダ		~200	~300	~400	~500	

※片開きはW270cmまで

CPS01 ブレーンシェードボトムボーダースタイル

H	W	コード式					ドラム式				
		30~45	~90	~140	~190	~240	30~45	~90	~140	~190	~240
50~100		32,600	40,600	49,800	67,000	76,400	35,600	43,600	52,800	70,000	79,400
~140		37,600	45,600	55,200	75,400	85,400	40,600	48,600	58,200	78,400	88,400
~180		42,400	50,600	60,600	84,000	94,200	45,400	53,600	63,600	87,000	97,200
~220		47,200	55,600	66,000	92,600	103,200	50,200	58,600	69,000	95,600	106,200
~260		52,000	60,600	71,400	101,000	112,000	55,000	63,600	74,400	104,000	115,000

※ドラム式:仕上り巾39cm以下の場合、仕上り丈は200cmまでとなります。(最大仕上り巾240cm)

CPS02 ブレーンシェードサイドボーダースタイル

H	W	コード式					ドラム式				
		30~45	~90	~140	~190	~240	30~45	~90	~140	~190	~240
50~100		32,600	40,600	49,800	67,000	76,400	35,600	43,600	52,800	70,000	79,400
~140		37,600	45,600	55,200	75,400	85,400	40,600	48,600	58,200	78,400	88,400
~180		42,400	50,600	60,600	84,000	94,200	45,400	53,600	63,600	87,000	97,200
~220		47,200	55,600	66,000	92,600	103,200	50,200	58,600	69,000	95,600	106,200
~260		52,000	60,600	71,400	101,000	112,000	55,000	63,600	74,400	104,000	115,000

※ドラム式:仕上り巾39cm以下の場合、仕上り丈は200cmまでとなります。(最大仕上り巾240cm)

style no.501 ロールソフトサイドボーダースタイル

スプリング・チェーンタイプ

H	W	30~60	~80	~100	~120	~140	~160±1	~170±1
50~80		50,500	53,000	55,000	56,200	57,900	60,400	63,000
~120		54,500	57,600	59,600	60,700	62,600	65,100	67,500
~160		58,400	62,200	64,200	65,400	66,700	69,100	71,600
~200		63,500	66,500	68,700	69,900	71,200	73,800	76,300
~240			71,000	73,300	74,500	75,900	78,400	80,900

※丈は巾の3倍までが限度です。(ただし~240cmまで)

※1 ボーダー巾によっては、製作ができない場合があります。

最大仕上り巾計算方法:生地巾-10cm+お好みのボーダー巾左右2本分=最大仕上り巾

※ロールソフト加工品は非防炎品になります。

TM-54147~54155

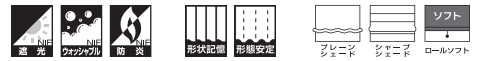

巾 ◇ 150cm 価格 ◇ 3,800円/m リポート ◇ タテ cm ヨコ cm 取扱い表示 ◇ リ-30 40 防炎性能 ◇ (イ) であて布使用
 組成 ◇ ポリエステル100% 寸法変化率 ◇ 水洗い/タテ -0.8% ヨコ -0.5% ドライ/タテ -1.0% ヨコ -0.8% Made in Japan

H	W	~67 1巾(片開き)	~150 2巾	~225 3巾	~300 4巾	~375 5巾	~450 6巾	~525 7巾
~100		9,700	19,300	27,500	35,800	44,100	52,300	60,600
~120		10,800	21,600	31,100	40,500	50,000	59,400	68,800
~140		12,000	24,000	34,600	45,200	55,900	66,500	77,100
~160		13,200	26,400	38,200	50,000	61,800	73,600	85,400
~180		14,400	28,700	41,700	54,700	67,700	80,600	93,600
~200		15,600	31,100	45,200	59,400	73,600	87,700	101,900
~220		16,700	33,400	48,800	64,100	79,500	94,800	110,100
~240		17,900	35,800	52,300	68,800	85,400	101,900	118,400
~260		19,100	38,200	55,900	73,600	91,300	109,000	126,700
~280		20,300	40,500	59,400	78,300	97,200	116,000	134,900
約1.5倍ヒダ		~88	~200	~300	~400	~500		

※片開きはW270cmまで

H	W	~67 1巾(片開き)	~150 2巾	~225 3巾	~300 4巾	~375 5巾	~450 6巾	~525 7巾
~100		10,100	20,100	28,800	37,500	46,200	54,800	63,500
~120		11,300	22,600	32,500	42,400	52,400	62,300	72,200
~140		12,600	25,100	36,200	47,400	58,600	69,700	80,900
~160		13,800	27,600	40,000	52,400	64,800	77,200	89,600
~180		15,000	30,000	43,700	57,300	71,000	84,600	98,200
~200		16,300	32,500	47,400	62,300	77,200	92,000	106,900
~220		17,500	35,000	51,100	67,200	83,400	99,500	115,600
~240		18,800	37,500	54,800	72,200	89,600	106,900	124,300
~260		20,000	40,000	58,600	77,200	95,800	114,400	133,000
~280		21,200	42,400	62,300	82,100	102,000	121,800	141,600
約1.5倍ヒダ		~88	~200	~300	~400	~500		

※片開きはW270cmまで

H	W	~67 1巾(片開き)	~150 2巾	~225 3巾	~300 4巾	~375 5巾	~450 6巾	~525 7巾	~600 8巾
~100		9,200	18,400	26,300	34,100	42,000	49,800	57,600	65,500
~120		10,400	20,700	29,600	38,600	47,600	56,500	65,500	74,400
~140		11,500	22,900	33,000	43,100	53,200	63,200	73,300	83,400
~160		12,600	25,200	36,400	47,600	58,800	70,000	81,200	92,400
~180		13,700	27,400	39,700	52,000	64,400	76,700	89,000	101,300
~200		14,800	29,600	43,100	56,500	70,000	83,400	96,800	110,300
~220		16,000	31,900	46,400	61,000	75,600	90,100	104,700	119,200
~240		17,100	34,100	49,800	65,500	81,200	96,800	112,500	128,200
~260		18,200	36,400	53,200	70,000	86,800	103,600	120,400	137,200
~280		19,300	38,600	56,500	74,400	92,400	110,300	128,200	146,100
約1.5倍ヒダ		~88	~200	~300	~400	~500	~600	~700	~800
フラット前1倍ヒダ		~130	~260	~410	~560				

H	W	~67 1巾(片開き)	~150 2巾	~225 3巾	~300 4巾	~375 5巾	~450 6巾	~525 7巾	~600 8巾
~100		10,900	21,800	31,300	40,800	50,400	59,900	69,400	78,900
~120		12,300	24,500	35,400	46,300	57,200	68,000	78,900	89,800
~140		13,600	27,200	39,500	51,700	64,000	76,200	88,400	100,700
~160		15,000	30,000	43,600	57,200	70,800	84,400	98,000	111,600
~180		16,400	32,700	47,600	62,600	77,600	92,500	107,500	122,400
~200		17,700	35,400	51,700	68,000	84,400	100,700	117,000	133,300
~220		19,100	38,100	55,800	73,500	91,200	108,800	126,500	144,200
~240		20,400	40,800	59,900	78,900	98,000	117,000	136,000	155,100
~260		21,800	43,600	64,000	84,400	104,800	125,200	145,600	166,000

※片開きはW300cmまで

		コード式				ドラム式								
H	W	30~45	~90	~140	~190	~240	30~45	~90	~140	~190	~240	~290	~340	~390
50~100		14,100	18,100	22,700	30,600	35,200	17,100	21,100	25,700	33,600	38,200	45,500	54,200	59,000
~140		16,300	20,400	25,100	34,400	39,300	19,300	23,400	28,100	37,400	42,300	49,800	60,000	64,900
~180		18,400	22,600	27,600	38,100	43,300	21,400	25,600	30,600	41,100	46,300	53,900	65,500	70,500
~220		20,600	24,800	30,000	41,900	47,300	23,600	27,800	33,000	44,900	50,300	58,200	71,200	76,300
~260		22,800	27,100	32,500	45,700	51,300	25,800	30,100	35,500	48,700	54,300	62,300	76,900	81,900
~300		25,000	29,300	35,000	49,500	55,300	28,000	32,300	38,000	52,500	58,300	66,700	82,500	87,800

※ドラム式: 仕上り巾39cm以下の場合、仕上り丈は200cmまでとなります。

		コード式	
H	W	18~30	~390
50~100		18,700	
~140		21,400	
~180		23,600	
~220		26,300	
~240		28,000	

		コード式				ドラム式								
H	W	30~45	~90	~140	~190	~240	30~45	~90	~140	~190	~240	~290	~340	~390
50~100		16,800	23,100	29,700	40,400	46,800	19,800	26,100	32,700	43,400	49,800	58,000	68,700	75,200
~140		19,300	25,900	33,000	45,600	52,500	22,300	28,900	36,000	48,600	55,500	64,100	76,500	83,300
~180		21,600	28,800	36,300	50,700	58,300	24,600	31,800	39,300	53,700	61,300	70,200	84,600	91,800
~220		24,100	31,600	39,600	55,900	64,000	27,100	34,600	42,600	58,900	67,000	76,300	92,100	99,800
~260		26,600	34,700	43,400	61,600	70,400	29,600	37,700	46,400	64,600	73,400	83,200	100,900	109,100
~300		29,200	37,800	47,100	67,300	76,800	32,200	40,800	50,100	70,300	79,800	90,100	109,700	118,300

※ドラム式: 仕上り巾39cm以下の場合、仕上り丈は200cmまでとなります。

		(片開き/タッセルなし)				
H	W	~72	~100	~127	~155	~183
~100		14,400	22,400	26,600	28,700	36,800
~140		16,100	25,800	30,000	32,100	41,800
~180		17,800	29,200	33,400	35,500	46,900
~220		19,500	32,600	36,800	38,900	52,000
~260		21,200	36,000	40,200	42,300	57,100
~300		22,900	39,400	43,600	45,700	62,200
26mm		-2,800	-2,100	-4,900	-4,200	-4,900
18mm		-4,900	-5,600	-9,100	-9,800	-10,500

※生地を伸ばした状態のサイズでご発注ください。

		スプリング・チェーンタイプ				
H	W	30~60	~80	~100	~120	~140
50~80		29,500	32,000	34,000	35,200	36,900
~120		31,800	34,900	36,900	38,000	39,900
~160		34,100	37,900	39,900	41,100	42,400
~200		37,500	40,500	42,700	43,900	45,200
~240			43,400	45,700	46,900	48,300

※丈は巾の3倍までが限度です。
 ※ロールソフト加工品は非防炎品になります。

		ストレートバランス				
H	W	~100	~150	~200	~250	~300
~40		10,700	16,900	21,300	25,700	31,900

※マジックテープ仕様・裏面スポンジ付の価格になります。

		三つ山・箱ヒダバランス (約2.5倍ヒダ)				
H	W	~100	~150	~200	~250	~300
~40		8,400	12,000	15,700	20,300	21,800

※マジックテープ仕様の価格になります。

プレーン		パイピング	
サイズ	価格	サイズ	価格
40x40	6,200	40x40	7,000
45x45	7,600	45x45	8,400
フリル付		フレーム付	
サイズ	価格	サイズ	価格
40x40	9,700	40x40	9,400
45x45	11,400	45x45	11,100

※中材込みの価格になります。

プレーン

CP01 バイアスボーダースタイル (形態安定加工)

(約2倍ヒダ/タッセル含む)

H	W	~150	~225	~300	~375	~450
~120		32,400	46,700	60,800	75,000	89,100
~140		36,000	51,900	67,800	83,900	99,800
~160		39,600	57,300	75,000	92,700	110,400
~180		43,100	62,600	82,100	101,600	120,900
~200		46,700	67,800	89,100	110,400	131,600
~220		50,100	73,200	96,200	119,300	142,200
~240		53,700	78,500	103,200	128,100	152,900
~260		57,300	83,900	110,400	137,000	163,500
約1.5倍ヒダ		~200	~300	~400	~500	

※片開きはW270cmまで

CP02 スリムボーダースタイル (形態安定加工)

(約2倍ヒダ/タッセル含む)

H	W	~150	~225	~300	~375	~450
~120		32,400	46,700	60,800	75,000	89,100
~140		36,000	51,900	67,800	83,900	99,800
~160		39,600	57,300	75,000	92,700	110,400
~180		43,100	62,600	82,100	101,600	120,900
~200		46,700	67,800	89,100	110,400	131,600
~220		50,100	73,200	96,200	119,300	142,200
~240		53,700	78,500	103,200	128,100	152,900
~260		57,300	83,900	110,400	137,000	163,500
約1.5倍ヒダ		~200	~300	~400	~500	

※片開きはW270cmまで

CP03 ミックスボーダースタイル (形態安定加工)

(約2倍ヒダ/タッセル含む)

H	W	~150	~225	~300	~375	~450
~120		32,400	46,700	60,800	75,000	89,100
~140		36,000	51,900	67,800	83,900	99,800
~160		39,600	57,300	75,000	92,700	110,400
~180		43,100	62,600	82,100	101,600	120,900
~200		46,700	67,800	89,100	110,400	131,600
~220		50,100	73,200	96,200	119,300	142,200
~240		53,700	78,500	103,200	128,100	152,900
~260		57,300	83,900	110,400	137,000	163,500
約1.5倍ヒダ		~200	~300	~400	~500	

※片開きはW270cmまで

CP04 トップボーダースタイル (形態安定加工)

(約2倍ヒダ/タッセル含む)

H	W	~150	~225	~300	~375	~450
~120		32,400	46,700	60,800	75,000	89,100
~140		36,000	51,900	67,800	83,900	99,800
~160		39,600	57,300	75,000	92,700	110,400
~180		43,100	62,600	82,100	101,600	120,900
~200		46,700	67,800	89,100	110,400	131,600
~220		50,100	73,200	96,200	119,300	142,200
~240		53,700	78,500	103,200	128,100	152,900
~260		57,300	83,900	110,400	137,000	163,500
約1.5倍ヒダ		~200	~300	~400	~500	

※片開きはW270cmまで

CP05 ボトムボーダースタイル (形態安定加工)

(約2倍ヒダ/タッセル含む)

H	W	~150	~225	~300	~375	~450
~120		32,400	46,700	60,800	75,000	89,100
~140		36,000	51,900	67,800	83,900	99,800
~160		39,600	57,300	75,000	92,700	110,400
~180		43,100	62,600	82,100	101,600	120,900
~200		46,700	67,800	89,100	110,400	131,600
~220		50,100	73,200	96,200	119,300	142,200
~240		53,700	78,500	103,200	128,100	152,900
~260		57,300	83,900	110,400	137,000	163,500
約1.5倍ヒダ		~200	~300	~400	~500	

※片開きはW270cmまで

CP06 サイドボーダースタイル (形態安定加工)

(約2倍ヒダ/タッセル含む)

H	W	~150	~225	~300	~375	~450
~120		32,400	46,700	60,800	75,000	89,100
~140		36,000	51,900	67,800	83,900	99,800
~160		39,600	57,300	75,000	92,700	110,400
~180		43,100	62,600	82,100	101,600	120,900
~200		46,700	67,800	89,100	110,400	131,600
~220		50,100	73,200	96,200	119,300	142,200
~240		53,700	78,500	103,200	128,100	152,900
~260		57,300	83,900	110,400	137,000	163,500
約1.5倍ヒダ		~200	~300	~400	~500	

※片開きはW270cmまで

CPS01 ブレーンシェードボトムボーダースタイル

H	W	コード式					ドラム式				
		30~45	~90	~140	~190	~240	30~45	~90	~140	~190	~240
50~100		31,200	39,200	48,400	64,200	73,400	34,200	42,200	51,400	67,200	76,400
~140		35,600	43,800	53,200	71,800	81,600	38,600	46,800	56,200	74,800	84,600
~180		39,800	48,200	58,200	79,200	89,600	42,800	51,200	61,200	82,200	92,600
~220		44,200	52,600	63,000	86,800	97,600	47,200	55,600	66,000	89,800	100,600
~260		48,600	57,200	68,000	94,400	105,600	51,600	60,200	71,000	97,400	108,600

※ドラム式: 仕上り巾39cm以下の場合、仕上り巾は200cmまでとなります。(最大仕上り巾240cm)

CPS02 ブレーンシェードサイドボーダースタイル

H	W	コード式					ドラム式				
		30~45	~90	~140	~190	~240	30~45	~90	~140	~190	~240
50~100		31,200	39,200	48,400	64,200	73,400	34,200	42,200	51,400	67,200	76,400
~140		35,600	43,800	53,200	71,800	81,600	38,600	46,800	56,200	74,800	84,600
~180		39,800	48,200	58,200	79,200	89,600	42,800	51,200	61,200	82,200	92,600
~220		44,200	52,600	63,000	86,800	97,600	47,200	55,600	66,000	89,800	100,600
~260		48,600	57,200	68,000	94,400	105,600	51,600	60,200	71,000	97,400	108,600

※ドラム式: 仕上り巾39cm以下の場合、仕上り巾は200cmまでとなります。(最大仕上り巾240cm)

style no.501 ロールソフトサイドボーダースタイル

スプリング・チェーンタイプ

H	W	30~60	~80	~100	~120	~140	~160±1	~170±1
50~80		49,100	51,600	53,600	54,800	56,500	59,000	61,600
~120		52,700	55,800	57,800	58,900	60,800	63,300	65,700
~160		56,200	60,000	62,000	63,200	64,500	66,900	69,400
~200		60,800	63,800	66,000	67,200	68,500	71,100	73,600
~240			67,900	70,200	71,400	72,800	75,300	77,800

※丈は巾の3倍までが限度です。(ただし~240cmまで)

ボーダー巾: 左右5~15cmまで指定可能(指定が無い場合左右10cm)

※1 ボーダー巾によっては、製作ができない場合があります。

最大仕上り巾計算方法: 生地巾-10cm+お好みのボーダー巾左右2本分=最大仕上り巾

※ロールソフト加工品は非防炎品になります。

TM-54156・54157



巾 ◇ 150cm 価格 ◇ 6,400円/m リポート ◇ タテ 23.5cm ヨコ 25.0cm 取扱い表示 ◇ リ-30 防炎性能 ◇ (イ) であって使用
 組成 ◇ ポリエステル100% 寸法変化率 ◇ 水洗い/タテ -0.3% ヨコ -0.5% ドライ/タテ 0.0% ヨコ -0.5% Made in Japan

標準仕様 形態安定加工価格表 約2倍ヒダ (タッセル含む)

H	W	~67 1巾(片開き)	~150 2巾	~225 3巾	~300 4巾	~375 5巾	~450 6巾	~525 7巾
~100	14,700	28,500	40,400	52,300	64,200	76,100	88,000	
~120	16,400	31,900	46,300	59,900	74,400	88,000	102,400	
~140	18,100	36,100	52,300	68,400	83,700	99,900	116,000	
~160	20,600	40,400	58,200	76,100	93,900	111,800	129,600	
~180	22,300	43,800	64,200	83,700	104,100	123,700	144,100	
~200	24,000	48,000	70,100	92,200	114,300	136,400	157,700	
~220	24,000	48,000	70,100	92,200	114,300	136,400	157,700	
~240	26,600	52,300	76,100	99,900	123,700	148,300	172,100	
~260	28,300	56,500	82,000	108,400	133,900	160,200	185,700	
~280	30,000	59,900	88,000	116,000	144,100	172,100	200,200	
約1.5倍ヒダ	~88	~200	~300	~400	~500			

※片開きはW270cmまで

プライム縫製仕様価格表 約2倍ヒダ (タッセル含む)

H	W	~67 1巾(片開き)	~150 2巾	~225 3巾	~300 4巾	~375 5巾	~450 6巾	~525 7巾
~100	15,200	29,400	41,700	54,000	66,400	78,700	91,000	
~120	17,000	32,900	47,800	61,900	76,900	91,000	105,900	
~140	18,700	37,200	54,000	70,700	86,500	103,300	120,000	
~160	21,300	41,700	60,100	78,700	97,100	115,600	134,000	
~180	23,000	45,200	66,400	86,500	107,600	128,000	149,100	
~200	24,800	49,600	72,400	95,300	118,200	141,100	163,200	
~220	24,800	49,600	72,400	95,300	118,200	141,100	163,200	
~240	27,500	54,000	78,700	103,300	128,000	153,400	178,000	
~260	29,300	58,400	84,800	112,100	138,500	165,700	192,100	
~280	31,000	61,900	91,000	120,000	149,100	178,000	207,200	
約1.5倍ヒダ	~88	~200	~300	~400	~500			

※片開きはW270cmまで

レギュラー縫製仕様価格表 約2倍ヒダ (タッセル含む)

H	W	~67 1巾(片開き)	~150 2巾	~225 3巾	~300 4巾	~375 5巾	~450 6巾	~525 7巾	~600 8巾
~100	14,300	27,600	39,100	50,600	62,100	73,600	85,000	96,500	
~120	15,900	30,900	44,800	57,900	71,900	85,000	98,900	112,000	
~140	17,600	35,000	50,600	66,100	80,900	96,500	112,000	127,700	
~160	20,000	39,100	56,300	73,600	90,700	108,000	125,200	143,200	
~180	21,600	42,400	62,100	80,900	100,600	119,500	139,200	158,000	
~200	23,200	46,400	67,800	89,100	110,400	131,700	152,300	173,600	
~220	23,200	46,400	67,800	89,100	110,400	131,700	152,300	173,600	
~240	25,800	50,600	73,600	96,500	119,500	143,200	166,200	189,100	
~260	27,400	54,600	79,200	104,700	129,300	154,700	179,300	204,800	
~280	29,000	57,900	85,000	112,000	139,200	166,200	193,300	220,300	
約1.5倍ヒダ	~88	~200	~300	~400	~500	~600	~700	~800	
フラット約1倍ヒダ	~130	~260	~410	~560					

形状記憶加工価格表 約2倍ヒダ (タッセル含む)

H	W	~67 1巾(片開き)	~150 2巾	~225 3巾	~300 4巾	~375 5巾	~450 6巾	~525 7巾	~600 8巾
~100	16,100	31,200	44,300	57,500	70,600	83,800	97,000	110,100	
~120	18,000	34,900	50,800	65,800	81,900	97,000	112,800	127,900	
~140	19,900	39,500	57,500	75,200	92,200	110,100	127,900	145,800	
~160	22,600	44,300	64,000	83,800	103,400	123,300	142,900	163,600	
~180	24,500	48,100	70,600	92,200	114,700	136,400	159,000	180,500	
~200	26,400	52,700	77,100	101,600	126,000	150,400	174,000	198,500	
~220	26,400	52,700	77,100	101,600	126,000	150,400	174,000	198,500	
~240	29,300	57,500	83,800	110,100	136,400	163,600	189,900	216,200	
~260	31,200	62,100	90,300	119,500	147,700	176,800	205,000	234,200	

※片開きはW300cmまで

style no.60 プレーンシェード

H	W	コード式					ドラム式							
		30~45	~90	~140	~190	~240	30~45	~90	~140	~190	~240	~290	~340	~390
50~100	18,500	22,400	27,000	38,500	43,200	21,500	25,400	30,000	41,500	46,200	53,600	66,100	70,900	
~140	20,500	24,500	29,200	41,900	46,800	23,500	27,500	32,200	44,900	49,800	57,500	71,800	76,700	
~180	24,100	28,100	33,200	48,500	53,600	27,100	31,100	36,200	51,500	56,600	64,500	81,100	86,100	
~220	27,300	31,300	36,500	54,600	59,900	30,300	34,300	39,500	57,600	62,900	71,200	90,600	95,700	
~260	29,700	33,900	39,300	58,500	64,000	32,700	36,900	42,300	61,500	67,000	75,400	96,300	101,300	
~300	32,900	37,000	42,700	64,600	70,400	35,900	40,000	45,700	67,600	73,400	82,100	105,600	110,900	

※ドラム式: 仕上り巾39cm以下の場合、仕上り巾は200cmまでとなります。

style no.63 シャープシェード

H	W	コード式					ドラム式							
		30~45	~90	~140	~190	~240	30~45	~90	~140	~190	~240	~290	~340	~390
50~100	21,400	27,600	34,300	48,900	55,300	24,400	30,600	37,300	51,900	58,300	66,500	81,100	87,700	
~140	23,600	30,300	37,400	53,600	60,600	26,600	33,300	40,400	56,600	63,600	72,100	88,900	95,700	
~180	27,500	34,600	42,200	61,800	69,400	30,500	37,600	45,200	64,800	72,400	81,300	100,900	108,200	
~220	30,800	38,400	46,400	69,400	77,500	33,800	41,400	49,400	72,400	80,500	89,800	112,400	120,100	
~260	33,700	41,900	50,500	75,300	84,100	36,700	44,900	53,500	78,300	87,100	96,900	121,100	129,300	
~300	37,200	45,900	55,200	83,400	93,000	40,200	48,900	58,200	86,400	96,000	106,200	133,900	142,500	

※ドラム式: 仕上り巾39cm以下の場合、仕上り巾は200cmまでとなります。

形態安定加工 推奨裏地付価格表(推奨裏地 TM-54419~54423) 約2倍ヒダ (タッセル含む)

H	W	~67 1巾(片開き)	~150 2巾	~225 3巾	~300 4巾	~375 5巾	~450 6巾	~525 7巾
~100	20,800	40,700	58,700	76,700	94,700	112,700	130,700	
~120	23,400	45,900	67,200	87,800	109,200	129,800	151,200	
~140	26,000	51,800	75,800	99,800	122,900	146,900	170,900	
~160	29,300	57,800	84,300	110,900	137,400	164,000	190,500	
~180	31,900	63,000	93,000	122,000	152,000	181,200	211,100	
~200	34,500	68,900	101,500	134,000	166,500	199,100	230,800	
~220	35,400	70,700	104,100	137,500	170,900	204,300	236,900	
~240	38,800	76,700	112,700	148,700	184,600	221,400	257,400	
~260	41,400	82,600	121,200	160,600	199,200	238,500	277,100	
~280	44,000	87,800	129,800	171,700	213,700	255,700	297,700	
約1.5倍ヒダ	~88	~200	~300	~400	~500			

※片開きはW270cmまで

プライム縫製仕様 推奨裏地付価格表(推奨裏地 TM-54419~54423) 約2倍ヒダ (タッセル含む)

H	W	~67 1巾(片開き)	~150 2巾	~225 3巾	~300 4巾	~375 5巾	~450 6巾	~525 7巾
~100	21,800	42,500	61,300	80,100	99,000	117,800	136,600	
~120	24,500	47,800	70,200	91,700	114,100	135,700	158,000	
~140	27,100	54,000	79,200	104,200	128,400	153,600	178,600	
~160	30,600	60,300	88,000	115,900	143,600	171,400	199,100	
~180	33,300	65,700	97,100	127,500	158,800	189,400	220,800	
~200	36,000	72,000	105,900	140,000	174,000	208,100	241,400	
~220	36,900	73,800	108,700	143,700	178,700	213,700	247,900	
~240	40,600	80,100	117,800	155,400	193,100	231,600	269,200	
~260	43,300	86,300	126,700	167,900	208,300	249,400	289,800	
~280	45,900	91,700	135,700	179,600	223,500	267,300	311,400	
約1.5倍ヒダ	~88	~200	~300	~400	~500			

※片開きはW270cmまで

レギュラー縫製仕様 推奨裏地付価格表(推奨裏地 TM-54419~54423) 約2倍ヒダ (タッセル含む)

H	W	~67 1巾(片開き)	~150 2巾	~225 3巾	~300 4巾	~375 5巾	~450 6巾	~525 7巾	~600 8巾
~100	20,000	39,000	56,200	73,300	90,500	107,700	124,700	141,900	
~120	22,400	43,900	64,300	83,900	104,300	123,900	144,300	163,900	
~140	24,900	49,600	72,500	95,300	117,400	140,300	163,100	186,100	
~160	28,100	55,300	80,600	106,000	131,200	156,600	181,900	208,000	
~180	30,600	60,300	88,900	116,600	145,200	173,000	201,600	229,300	
~200	33,000	65,900	97,000	128,000	159,000	190,100	220,400	251,400	
~220	33,800	67,500	99,400	131,300	163,100	194,900	226,100	257,900	
~240	37,200	73,300	107,700	141,900	176,200	211,300	245,600	279,900	
~260	39,600	78,900	115,700	153,300	190,100	227,600	264,400	302,000	
~280									

TM-54158・54159

巾 ◇ 150cm 価格 ◇ 6,800円/m
組成 ◇ ポリエステル100%

リポート ◇ タテ 32.5cm ヨコ 50.0cm
寸法変化率 ◇ 水洗い/タテ -0.5% ヨコ -0.5%
ドライ/タテ -0.8% ヨコ -0.5%

取扱い表示 ◇ リ-30 30 40 50 60 70 80 90 100
防炎性能 ◇ (イ) ちて布使用
Made in Japan



標準仕様 形態安定加工価格表 約2倍ヒダ (タッセル含む)

H	W	形態安定加工価格表 約2倍ヒダ (タッセル含む)						
		~67 1巾(片開き)	~150 2巾	~225 3巾	~300 4巾	~375 5巾	~450 6巾	~525 7巾
~100	17,200	33,400	47,600	61,900	76,900	91,200	105,400	
~120	17,200	33,400	47,600	61,900	76,900	91,200	105,400	
~140	19,800	38,700	56,500	73,400	91,200	108,200	126,000	
~160	22,500	44,900	65,400	85,000	105,400	126,000	146,400	
~180	22,500	44,900	65,400	85,000	105,400	126,000	146,400	
~200	25,100	50,200	73,400	96,500	119,700	142,800	165,900	
~220	25,100	50,200	73,400	96,500	119,700	142,800	165,900	
~240	28,700	56,500	82,300	108,200	134,900	160,600	186,500	
~260	31,400	61,900	91,200	119,700	149,100	177,600	206,900	
~280	31,400	61,900	91,200	119,700	149,100	177,600	206,900	
約1.5倍ヒダ	~88	~200	~300	~400	~500			

※片開きはW270cmまで

プライム縫製仕様価格表 約2倍ヒダ (タッセル含む)

H	W	プライム縫製仕様価格表 約2倍ヒダ (タッセル含む)						
		~67 1巾(片開き)	~150 2巾	~225 3巾	~300 4巾	~375 5巾	~450 6巾	~525 7巾
~100	17,700	34,400	49,100	63,800	79,400	94,100	108,800	
~120	17,700	34,400	49,100	63,800	79,400	94,100	108,800	
~140	20,400	39,900	58,300	75,700	94,100	111,700	130,100	
~160	23,200	46,300	67,500	87,800	108,800	130,100	151,200	
~180	23,200	46,300	67,500	87,800	108,800	130,100	151,200	
~200	25,900	51,800	75,700	99,600	123,600	147,500	171,400	
~220	25,900	51,800	75,700	99,600	123,600	147,500	171,400	
~240	29,600	58,300	84,900	111,700	139,300	165,900	192,600	
~260	32,400	63,800	94,100	123,600	154,000	183,400	213,700	
~280	32,400	63,800	94,100	123,600	154,000	183,400	213,700	
約1.5倍ヒダ	~88	~200	~300	~400	~500			

※片開きはW270cmまで

レギュラー縫製仕様価格表 約2倍ヒダ (タッセル含む)

H	W	レギュラー縫製仕様価格表 約2倍ヒダ (タッセル含む)							
		~67 1巾(片開き)	~150 2巾	~225 3巾	~300 4巾	~375 5巾	~450 6巾	~525 7巾	~600 8巾
~100	16,700	32,400	46,200	59,900	74,500	88,200	102,000	115,800	
~120	16,700	32,400	46,200	59,900	74,500	88,200	102,000	115,800	
~140	19,200	37,600	54,800	71,000	88,200	104,600	121,800	138,100	
~160	21,800	43,500	63,400	82,300	102,000	121,800	141,600	160,500	
~180	21,800	43,500	63,400	82,300	102,000	121,800	141,600	160,500	
~200	24,400	48,700	71,000	93,400	115,800	138,100	160,500	182,800	
~220	24,400	48,700	71,000	93,400	115,800	138,100	160,500	182,800	
~240	27,800	54,800	79,600	104,600	130,400	155,300	180,300	205,200	
~260	30,400	59,900	88,200	115,800	144,200	171,700	200,000	227,600	
~280	30,400	59,900	88,200	115,800	144,200	171,700	200,000	227,600	
約1.5倍ヒダ	~88	~200	~300	~400	~500	~600	~700	~800	
フラット前ヒダ	~130	~260	~410	~560					

形状記憶加工価格表 約2倍ヒダ (タッセル含む)

H	W	形状記憶加工価格表 約2倍ヒダ (タッセル含む)							
		~67 1巾(片開き)	~150 2巾	~225 3巾	~300 4巾	~375 5巾	~450 6巾	~525 7巾	~600 8巾
~100	18,800	36,400	52,100	67,800	84,300	100,000	115,700	131,400	
~120	18,800	36,400	52,100	67,800	84,300	100,000	115,700	131,400	
~140	21,600	42,300	61,900	80,400	100,000	118,700	138,300	156,800	
~160	24,600	49,000	71,700	93,200	115,700	138,300	160,800	182,300	
~180	24,600	49,000	71,700	93,200	115,700	138,300	160,800	182,300	
~200	27,500	54,900	80,400	105,900	131,400	156,800	182,300	207,800	
~220	27,500	54,900	80,400	105,900	131,400	156,800	182,300	207,800	
~240	31,400	61,900	90,200	118,700	148,100	176,400	205,000	233,300	
~260	34,400	67,800	100,000	131,400	163,800	195,200	227,400	258,800	

※片開きはW300cmまで

style no.60 プレーンシェード

H	W	コード式				ドラム式							
		30~45	~90	~140	~190	30~45	~90	~140	~190	~240	~290	~340	~390
50~100	17,800	21,800	26,300	37,800	42,400	20,800	24,800	29,300	40,800	45,400	52,800	65,200	70,000
~140	21,100	25,100	29,800	43,000	47,900	24,100	28,100	32,800	46,000	50,900	58,700	72,900	77,800
~180	25,500	29,500	34,500	51,700	56,800	28,500	32,500	37,500	54,700	59,800	67,700	86,200	91,200
~220	28,200	32,200	37,400	56,300	61,700	31,200	35,200	40,400	59,300	64,700	72,900	93,300	98,400
~260	31,400	35,500	40,900	61,500	67,100	34,400	38,500	43,900	64,500	70,100	78,500	100,900	105,900
~300	34,000	38,200	43,800	66,200	72,000	37,000	41,200	46,800	69,200	75,000	83,700	108,400	113,700

※ドラム式：仕上り巾39cm以下の場合、仕上り丈は200cmまでとなります。

style no.63 シャープシェード

H	W	コード式				ドラム式							
		30~45	~90	~140	~190	30~45	~90	~140	~190	~240	~290	~340	~390
50~100	20,700	27,000	33,600	48,100	54,500	23,700	30,000	36,600	51,100	57,500	65,700	80,200	86,800
~140	24,200	30,900	38,000	54,800	61,800	27,200	33,900	41,000	57,800	64,800	73,300	90,100	96,900
~180	28,900	36,000	43,600	65,200	72,700	31,900	39,000	46,600	68,200	75,700	84,700	106,300	113,600
~220	31,800	39,300	47,400	71,300	79,400	34,800	42,300	50,400	74,300	82,400	91,700	115,300	122,900
~260	35,400	43,500	52,200	78,500	87,400	38,400	46,500	55,200	81,500	90,400	100,100	126,000	134,200
~300	38,400	47,100	56,400	85,200	94,700	41,400	50,100	59,400	88,200	97,700	108,000	136,800	145,500

※ドラム式：仕上り巾39cm以下の場合、仕上り丈は200cmまでとなります。

形態安定加工 推奨裏地付価格表(推奨裏地TM-54419~54423) 約2倍ヒダ (タッセル含む)

H	W	形態安定加工 推奨裏地付価格表(推奨裏地TM-54419~54423) 約2倍ヒダ (タッセル含む)						
		~67 1巾(片開き)	~150 2巾	~225 3巾	~300 4巾	~375 5巾	~450 6巾	~525 7巾
~100	23,300	45,600	65,900	86,300	107,400	127,800	148,100	
~120	24,200	47,400	68,500	89,800	111,700	133,000	154,200	
~140	27,700	54,400	80,000	104,800	130,400	155,200	180,900	
~160	31,200	62,300	91,500	119,800	148,900	178,200	207,300	
~180	32,100	64,100	94,200	123,300	153,300	183,500	213,400	
~200	35,600	71,100	104,800	138,300	171,900	205,500	239,000	
~220	36,500	72,900	107,400	141,800	176,300	210,700	245,100	
~240	40,900	80,900	118,900	157,000	195,800	233,700	271,800	
~260	44,500	88,000	130,400	171,900	214,400	255,900	298,300	
~280	45,400	89,800	133,000	175,400	218,700	261,200	304,400	
約1.5倍ヒダ	~88	~200	~300	~400	~500			

※片開きはW270cmまで

プライム縫製仕様 推奨裏地付価格表(推奨裏地TM-54419~54423) 約2倍ヒダ (タッセル含む)

H	W	プライム縫製仕様 推奨裏地付価格表(推奨裏地TM-54419~54423) 約2倍ヒダ (タッセル含む)						
		~67 1巾(片開き)	~150 2巾	~225 3巾	~300 4巾	~375 5巾	~450 6巾	~525 7巾
~100	24,300	47,500	68,700	89,900	112,000	133,200	154,400	
~120	25,200	49,300	71,500	93,600	116,600	138,800	160,900	
~140	28,800	56,700	83,500	109,200	136,000	162,000	188,700	
~160	32,500	64,900	95,400	125,000	155,300	185,900	216,300	
~180	33,500	66,800	98,200	128,800	160,000	191,500	222,900	
~200	37,100	74,200	109,200	144,300	179,400	214,500	249,600	
~220	38,000	76,000	112,000	148,000	184,100	220,100	256,100	
~240	42,700	84,400	124,000	163,800	204,400	244,100	283,800	
~260	46,400	91,700	136,000	179,400	223,800	267,100	311,400	
~280	47,300	93,600	138,800	183,200	228,400	272,700	317,900	
約1.5倍ヒダ	~88	~200	~300	~400	~500			

※片開きはW270cmまで

レギュラー縫製仕様 推奨裏地付価格表(推奨裏地TM-54419~54423) 約2倍ヒダ (タッセル含む)

H	W	レギュラー縫製仕様 推奨裏地付価格表(推奨裏地TM-54419~54423) 約2倍ヒダ (タッセル含む)							
		~67 1巾(片開き)	~150 2巾	~225 3巾	~300 4巾	~375 5巾	~450 6巾	~525 7巾	~600 8巾
~100	22,400	43,800	63,300	82,600	102,900	122,300	141,700	161,200	
~120	23,200	45,400	65,700	85,900	106,900	127,100	147,400	167,700	
~140	26,500	52,200	76,700	100,200	124,700	148,400	172,900	196,500	
~160	29,900	59,700	87,700	114,700	142,500	170,400	198,300	225,300	
~180	30,800	61,400	90,200	118,000	146,600	175,300	204,000	231,800	
~200	34,200	68,200	100,200	132,300	164,400	196,500	228,600	260,600	
~220	35,000	69,800	102,600	135,600	168,500	201,300	234,300	267,100	
~240	39,200	77,500	113,700	150,000	187,100	223,400	259,700	296,000	
~260	42,600	84,200	124,700	164,400	205,000	244,600	285,100	324,800	
~280	43,400	85,900	127,100	167,700	209,000	249,500	290,800	331,300	
約1.5倍ヒダ	~88	~200	~300	~400	~500	~600	~700	~800	

スリムシェード

TM-54160・54161



巾 ◇ 150cm 価格 ◇ 5,400円/m リポート ◇ タテ42.0cm ヨコ30.0cm 取扱い表示 ◇ リ-30 防炎性能 ◇ (イ)
 組成 ◇ ポリエステル100% 寸法変化率 ◇ 水洗い/タテ -0.3% ヨコ -0.5% ドライ/タテ -0.5% ヨコ 0.0% Made in Japan

H	W	~67 1巾(片開き)	~150 2巾	~225 3巾	~300 4巾	~375 5巾	~450 6巾	~525 7巾
~100		14,500	28,900	41,700	54,400	66,400	79,200	91,900
~120		14,500	28,900	41,700	54,400	66,400	79,200	91,900
~140		17,500	34,900	50,700	66,400	82,200	97,900	113,700
~160		17,500	34,900	50,700	66,400	82,200	97,900	113,700
~180		21,200	41,700	60,400	79,200	97,900	117,400	136,200
~200		21,200	41,700	60,400	79,200	97,900	117,400	136,200
~220		24,200	47,700	70,200	91,900	113,700	136,200	157,900
~240		24,200	47,700	70,200	91,900	113,700	136,200	157,900
~260		27,200	54,400	79,200	104,700	129,400	154,900	180,400
~280		27,200	54,400	79,200	104,700	129,400	154,900	180,400
約1.5倍ヒダ		~88	~200	~300	~400	~500		

※片開きはW270cmまで

H	W	~67 1巾(片開き)	~150 2巾	~225 3巾	~300 4巾	~375 5巾	~450 6巾	~525 7巾
~100		15,100	29,900	43,300	56,400	68,900	82,300	95,400
~120		15,100	29,900	43,300	56,400	68,900	82,300	95,400
~140		18,200	36,200	52,600	68,900	85,400	101,700	118,100
~160		18,200	36,200	52,600	68,900	85,400	101,700	118,100
~180		22,000	43,300	62,700	82,300	101,700	122,000	141,500
~200		22,000	43,300	62,700	82,300	101,700	122,000	141,500
~220		25,100	49,500	72,900	95,400	118,100	141,500	164,100
~240		25,100	49,500	72,900	95,400	118,100	141,500	164,100
~260		28,200	56,400	82,300	108,800	134,400	161,000	187,500
~280		28,200	56,400	82,300	108,800	134,400	161,000	187,500
約1.5倍ヒダ		~88	~200	~300	~400	~500		

※片開きはW270cmまで

H	W	~67 1巾(片開き)	~150 2巾	~225 3巾	~300 4巾	~375 5巾	~450 6巾	~525 7巾	~600 8巾
~100		14,000	27,900	40,200	52,400	63,900	76,200	88,400	100,700
~120		14,000	27,900	40,200	52,400	63,900	76,200	88,400	100,700
~140		16,900	33,600	48,800	63,900	79,100	94,100	109,300	124,400
~160		16,900	33,600	48,800	63,900	79,100	94,100	109,300	124,400
~180		20,400	40,200	58,100	76,200	94,100	112,800	130,900	148,800
~200		20,400	40,200	58,100	76,200	94,100	112,800	130,900	148,800
~220		23,300	45,900	67,500	88,400	109,300	130,900	151,700	173,300
~240		23,300	45,900	67,500	88,400	109,300	130,900	151,700	173,300
~260		26,200	52,400	76,200	100,700	124,400	148,800	173,300	197,100
~280		26,200	52,400	76,200	100,700	124,400	148,800	173,300	197,100
約1.5倍ヒダ		~88	~200	~300	~400	~500	~600	~700	~800
フラット約1倍ヒダ		~130	~260	~410	~560				

H	W	~67 1巾(片開き)	~150 2巾	~225 3巾	~300 4巾	~375 5巾	~450 6巾	~525 7巾	~600 8巾
~100		16,100	32,000	46,300	60,500	74,000	88,300	102,500	116,900
~120		16,100	32,000	46,300	60,500	74,000	88,300	102,500	116,900
~140		19,500	38,700	56,400	74,000	91,700	109,200	127,000	144,500
~160		19,500	38,700	56,400	74,000	91,700	109,200	127,000	144,500
~180		23,600	46,300	67,200	88,300	109,200	131,100	152,200	173,100
~200		23,600	46,300	67,200	88,300	109,200	131,100	152,200	173,100
~220		26,900	53,100	78,300	102,500	127,000	152,200	176,400	201,600
~240		26,900	53,100	78,300	102,500	127,000	152,200	176,400	201,600
~260		30,300	60,500	88,300	116,900	144,500	173,100	201,600	229,500

※片開きはW300cmまで

		コード式					ドラム式							
H	W	30~45	~90	~140	~190	~240	30~45	~90	~140	~190	~240	~290	~340	~390
50~100		16,200	20,200	24,800	34,700	39,400	19,200	23,200	27,800	37,700	42,400	49,700	60,100	64,900
~140		19,000	23,000	27,800	39,600	44,500	22,000	26,000	30,800	42,600	47,500	55,200	68,000	72,800
~180		21,700	25,800	30,800	44,400	49,600	24,700	28,800	33,800	47,400	52,600	60,400	75,100	80,100
~220		25,000	29,100	34,300	49,700	55,100	28,000	32,100	37,300	52,700	58,100	66,200	82,900	88,100
~260		27,700	31,800	37,300	54,600	60,100	30,700	34,800	40,300	57,600	63,100	71,400	90,800	95,800
~300		30,400	34,700	40,300	59,900	65,700	33,400	37,700	43,300	62,900	68,700	77,300	98,000	103,300

※ドラム式: 仕上り巾39cm以下の場合、仕上り巾は200cmまでとなります。

		コード式					ドラム式							
H	W	30~45	~90	~140	~190	~240	30~45	~90	~140	~190	~240	~290	~340	~390
50~100		19,000	25,300	31,900	44,900	51,200	22,000	28,300	34,900	47,900	54,200	62,400	74,800	81,400
~140		22,000	28,700	35,800	51,200	58,100	25,000	31,700	38,800	54,200	61,100	69,700	84,900	91,700
~180		25,000	32,200	39,700	57,500	65,000	28,000	35,200	42,700	60,500	68,000	76,900	94,700	101,900
~220		28,500	36,100	44,100	64,200	72,400	31,500	39,100	47,100	67,200	75,400	84,600	104,500	112,100
~260		31,600	39,700	48,400	71,100	79,900	34,600	42,700	51,400	74,100	82,900	92,700	115,400	123,600
~300		34,700	43,400	52,700	78,400	88,000	37,700	46,400	55,700	81,400	91,000	101,300	125,900	134,600

※ドラム式: 仕上り巾39cm以下の場合、仕上り巾は200cmまでとなります。

H	W	~67 1巾(片開き)	~150 2巾	~225 3巾	~300 4巾	~375 5巾	~450 6巾	~525 7巾
~100		20,600	41,100	60,000	78,800	96,900	115,800	134,600
~120		21,500	42,900	62,600	82,300	101,200	121,000	140,700
~140		25,400	50,600	74,200	97,800	121,400	144,900	168,600
~160		26,200	52,300	76,800	101,200	125,700	150,100	174,600
~180		30,800	60,900	89,200	117,500	145,800	174,900	203,200
~200		31,700	62,600	91,800	121,000	150,100	180,100	209,300
~220		35,600	70,400	104,200	137,200	170,300	204,100	237,100
~240		36,400	72,100	106,800	140,700	174,600	209,300	243,200
~260		40,300	80,500	118,400	156,900	194,700	233,200	271,800
~280		41,200	82,300	121,000	160,400	199,000	238,500	277,900
約1.5倍ヒダ		~88	~200	~300	~400	~500		

※片開きはW270cmまで

H	W	~67 1巾(片開き)	~150 2巾	~225 3巾	~300 4巾	~375 5巾	~450 6巾	~525 7巾
~100		21,700	43,000	62,900	82,500	101,500	121,400	141,000
~120		22,600	44,800	65,700	86,200	106,100	127,000	147,500
~140		26,600	53,000	77,800	102,400	127,300	152,000	176,700
~160		27,500	54,800	80,500	106,100	131,900	157,500	183,200
~180		32,300	63,800	93,400	123,300	152,900	183,400	213,200
~200		33,200	65,700	96,200	127,000	157,500	189,000	219,700
~220		37,200	73,700	109,200	143,800	178,600	214,100	248,800
~240		38,200	75,600	112,000	147,500	183,200	219,700	255,300
~260		42,200	84,300	124,200	164,600	204,200	244,700	285,200
~280		43,100	86,200	127,000	168,400	208,800	250,300	291,700
約1.5倍ヒダ		~88	~200	~300	~400	~500		

※片開きはW270cmまで

H	W	~67 1巾(片開き)	~150 2巾	~225 3巾	~300 4巾	~375 5巾	~450 6巾	~525 7巾	~600 8巾
~100		19,700	39,300	57,300	75,100	92,300	110,300	128,100	146,100
~120		20,500	40,900	59,700	78,400	96,300	115,100	133,800	152,600
~140		24,200	48,200	70,700	93,100	115,600	137,900	160,400	182,800
~160		25,000	49,800	73,100	96,300	119,600	142,700	166,000	189,200
~180		29,400	58,100	84,900	111,900	138,700	166,300	193,300	220,100
~200		30,200	59,700	87,300	115,100	142,700	171,200	199,000	226,600
~220		33,900	67,000	99,100	130,600	162,000	194,100	225,500	257,600
~240		34,700	68,600	101,600	133,800	166,000	199,000	231,100	264,100
~260		38,400	76,700	112,700	149,300	185,200	221,700	258,400	294,300
~280		39,200	78,400	115,100	152,600	189,200	226,600	264,100	300,800
約1.5倍ヒダ		~88	~200	~300	~400	~500	~600	~700	~800

		コード式
H	W	

TM-54162・54163



巾 ◇ 150cm 価格 ◇ 7,000円/m
組成 ◇ ポリエステル100%

リポート ◇ タテ 6.2cm ヨコ 25.0cm
寸法変化率 ◇ 水洗い/タテ -0.3% ヨコ -0.3%
ドライ/タテ 0.0% ヨコ 0.0%

取扱い表示 ◇ リ-30
防炎性能 ◇ (イ)
Made in Japan

H	W	~67 1巾(片開き)	~150 2巾	~225 3巾	~300 4巾	~375 5巾	~450 6巾	~525 7巾
~100		15,800	30,500	43,200	56,000	69,600	82,300	95,000
~120		17,600	34,100	48,700	63,300	77,800	92,400	106,900
~140		18,400	36,800	53,200	69,600	85,900	102,300	118,700
~160		21,200	41,400	60,500	78,700	97,800	116,000	135,100
~180		23,000	45,100	65,100	85,900	106,000	126,000	147,000
~200		24,900	48,700	70,500	92,400	114,200	136,100	158,700
~220		25,700	51,400	76,000	99,700	123,300	147,000	170,600
~240		28,500	56,000	82,300	107,800	134,200	160,600	186,000
~260		30,300	59,600	87,800	115,100	142,400	170,600	197,900
~280		32,100	63,300	92,400	121,500	151,500	180,600	209,700
約1.5倍ヒダ		~88	~200	~300	~400	~500		

※片開きはW270cmまで

H	W	~67 1巾(片開き)	~150 2巾	~225 3巾	~300 4巾	~375 5巾	~450 6巾	~525 7巾
~100		16,200	31,400	44,500	57,700	71,700	84,900	98,000
~120		18,100	35,100	50,200	65,200	80,300	95,300	110,300
~140		19,000	37,900	54,800	71,700	88,600	105,600	122,500
~160		21,900	42,700	62,300	81,100	100,900	119,700	139,400
~180		23,700	46,400	67,100	88,600	109,300	130,000	151,700
~200		25,600	50,200	72,700	95,300	117,900	140,400	163,800
~220		26,500	52,900	78,400	102,800	127,300	151,700	176,100
~240		29,400	57,700	84,900	111,200	138,500	165,700	192,000
~260		31,300	61,500	90,500	118,700	146,900	176,100	204,300
~280		33,100	65,200	95,300	125,400	156,300	186,400	216,500
約1.5倍ヒダ		~88	~200	~300	~400	~500		

※片開きはW270cmまで

H	W	~67 1巾(片開き)	~150 2巾	~225 3巾	~300 4巾	~375 5巾	~450 6巾	~525 7巾	~600 8巾
~100		15,300	29,600	41,900	54,300	67,400	79,700	92,000	104,400
~120		17,100	33,100	47,200	61,300	75,400	89,500	103,500	117,600
~140		17,900	35,700	51,600	67,400	83,200	99,100	114,900	130,800
~160		20,600	40,200	58,600	76,200	94,700	112,300	130,800	148,400
~180		22,300	43,700	63,100	83,200	102,600	122,000	142,300	161,600
~200		24,100	47,200	68,300	89,500	110,600	131,700	153,600	174,800
~220		24,900	49,800	73,600	96,500	119,400	142,300	165,100	188,000
~240		27,600	54,300	79,700	104,400	129,900	155,400	180,000	205,600
~260		29,400	57,800	85,000	111,400	137,800	165,100	191,500	217,900
~280		31,100	61,300	89,500	117,600	146,600	174,800	202,900	231,100
約1.5倍ヒダ		~88	~200	~300	~400	~500	~600	~700	~800
フラット前ヒダ		~130	~260	~410	~560				

H	W	~67 1巾(片開き)	~150 2巾	~225 3巾	~300 4巾	~375 5巾	~450 6巾	~525 7巾	~600 8巾
~100		17,100	33,100	47,100	61,100	76,000	90,000	104,000	118,000
~120		19,100	37,100	53,100	69,100	85,100	101,100	117,100	133,100
~140		20,000	40,000	58,000	76,000	94,000	112,000	130,000	148,000
~160		23,100	45,100	66,000	86,000	107,100	127,100	148,000	168,000
~180		25,100	49,100	71,100	94,000	116,000	138,000	161,100	183,100
~200		27,100	53,100	77,100	101,100	125,100	149,100	174,000	198,000
~220		28,000	56,000	83,100	109,100	135,100	161,100	187,100	213,100
~240		31,100	61,100	90,000	118,000	147,100	176,000	204,000	233,100
~260		33,100	65,100	96,000	126,000	156,000	187,100	217,100	247,100

※片開きはW300cmまで

H	W	コード式				ドラム式								
		30~45	~90	~140	~240	30~45	~90	~140	~190	~240	~290	~340	~390	
50~100		18,100	22,000	26,600	37,600	42,300	21,100	25,000	29,600	40,600	45,300	52,700	65,300	70,100
~140		21,400	25,400	30,100	43,500	48,500	24,400	28,400	33,100	46,500	51,500	59,200	73,800	78,700
~180		24,700	28,700	33,700	49,500	54,600	27,700	31,700	36,700	52,500	57,600	65,500	83,200	88,200
~220		28,000	32,000	37,200	55,400	60,800	31,000	35,000	40,200	58,400	63,800	72,000	91,600	96,700
~260		31,300	35,400	40,800	61,400	66,900	34,300	38,400	43,800	64,400	69,900	78,300	101,300	106,300
~300		34,600	38,700	44,400	67,300	73,100	37,600	41,700	47,400	70,300	76,100	84,900	109,500	114,800

※ドラム式：仕上り巾39cm以下の場合、仕上り丈は200cmまでとなります。

H	W	コード式
50~100		18~30
~140		22,300
~180		26,100
~220		29,300
~240		33,000
~240		34,600

H	W	スプリング・チェーンタイプ				
		30~60	~80	~100	~120	~140
50~80		33,100	35,600	37,600	38,800	40,500
~120		36,500	39,600	41,600	42,700	44,600
~160		39,800	43,600	45,600	46,800	48,100
~200		44,200	47,200	49,400	50,600	51,900
~240			51,100	53,400	54,600	56,000

※丈は巾の3倍までが限度です。
※ロールソフト加工品は非防炎品になります。

H	W	38mm	約72	~100	~127	~155	~183
~100		18,700	30,300	34,500	36,600	48,200	
~140		20,700	35,000	39,200	41,300	55,700	
~180		24,100	41,200	45,400	47,500	64,500	
~220		26,100	45,900	50,100	52,200	72,700	
~260		29,600	52,100	56,300	58,400	81,500	
~300		32,300	57,500	61,700	63,800	89,000	
26mm		-2,800	-2,100	-4,900	-4,200	-4,900	
18mm		-4,900	-5,600	-9,100	-9,800	-10,500	

※生地を伸ばした状態のサイズでご発注ください。

ストレートバランス						
H	W	~100	~150	~200	~250	~300
~40		12,800	20,500	24,900	29,300	37,100

※マジックテープ仕様・裏面スポンジ付の価格になります。

三つ山・箱ヒダバランス (約2.5倍ヒダ)						
H	W	~100	~150	~200	~250	~300
~40		12,500	18,500	23,900	30,900	32,400

※マジックテープ仕様の価格になります。

TM-54164・54165



巾 ◇ 100cm 価格 ◇ 6,500円/㎡ リピー ト ◇ タテ 51.4cm ヨコ 50.3cm 取扱い表示 ◇ リ-30 40 炎 1 2 3 4 5 6 7 8 9 10 11 12 13 14 15 16 17 18 19 20 21 22 23 24 25 26 27 28 29 30 31 32 33 34 35 36 37 38 39 40 41 42 43 44 45 46 47 48 49 50 51 52 53 54 55 56 57 58 59 60 61 62 63 64 65 66 67 68 69 70 71 72 73 74 75 76 77 78 79 80 81 82 83 84 85 86 87 88 89 90 91 92 93 94 95 96 97 98 99 100
 組 成 ◇ ポリエステル100% 寸法変化率 ◇ 水洗い/タテ 0.0% ヨコ 0.0% 防炎性能 ◇ (イ) 乾燥機/タテ -0.2% ヨコ 0.0% Made in Japan
 あて布使用

標準仕様 形態安定加工価格表 約2倍ヒダ (タッセル含む)

H	W	~44 1巾(片開き)	~100 2巾	~150 3巾	~200 4巾	~250 5巾	~300 6巾	~350 7巾	~400 8巾
~100		14,600	28,300	41,000	52,800	65,500	77,300	89,200	101,800
~120		18,500	37,000	52,800	69,400	85,200	101,800	117,600	134,200
~140		18,500	37,000	52,800	69,400	85,200	101,800	117,600	134,200
~160		18,500	37,000	52,800	69,400	85,200	101,800	117,600	134,200
~180		22,500	44,900	65,500	85,200	105,800	126,300	146,000	166,600
~200		22,500	44,900	65,500	85,200	105,800	126,300	146,000	166,600
~220		22,500	44,900	65,500	85,200	105,800	126,300	146,000	166,600
~240		26,400	52,800	77,300	101,800	126,300	150,000	174,500	199,000
~260		26,400	52,800	77,300	101,800	126,300	150,000	174,500	199,000
~280		30,400	60,700	89,200	117,600	146,000	174,500	202,900	231,400
約1.5倍ヒダ		~56	~120	~200	~266	~333	~400	~466	~533

※片開きはW270cmまで

プライム縫製仕様価格表 約2倍ヒダ (タッセル含む)

H	W	~44 1巾(片開き)	~100 2巾	~150 3巾	~200 4巾	~250 5巾	~300 6巾	~350 7巾	~400 8巾
~100		14,900	29,000	41,900	54,100	67,000	79,200	91,300	104,300
~120		19,000	37,900	54,100	71,100	87,300	104,300	120,500	137,500
~140		19,000	37,900	54,100	71,100	87,300	104,300	120,500	137,500
~160		19,000	37,900	54,100	71,100	87,300	104,300	120,500	137,500
~180		23,000	46,000	67,000	87,300	108,300	129,400	149,600	170,700
~200		23,000	46,000	67,000	87,300	108,300	129,400	149,600	170,700
~220		23,000	46,000	67,000	87,300	108,300	129,400	149,600	170,700
~240		27,100	54,100	79,200	104,300	129,400	153,700	178,800	203,900
~260		27,100	54,100	79,200	104,300	129,400	153,700	178,800	203,900
~280		31,100	62,200	91,300	120,500	149,600	178,800	208,000	237,100
約1.5倍ヒダ		~56	~120	~200	~266	~333	~400	~466	~533

※片開きはW270cmまで

レギュラー縫製仕様価格表 約2倍ヒダ (タッセル含む)

H	W	~44 1巾(片開き)	~100 2巾	~150 3巾	~200 4巾	~250 5巾	~300 6巾	~350 7巾	~400 8巾
~100		14,300	27,700	40,000	51,600	63,900	75,500	87,000	99,300
~120		18,100	36,200	51,600	67,800	83,200	99,300	114,700	130,900
~140		18,100	36,200	51,600	67,800	83,200	99,300	114,700	130,900
~160		18,100	36,200	51,600	67,800	83,200	99,300	114,700	130,900
~180		22,000	43,900	63,900	83,200	103,200	123,200	142,400	162,500
~200		22,000	43,900	63,900	83,200	103,200	123,200	142,400	162,500
~220		22,000	43,900	63,900	83,200	103,200	123,200	142,400	162,500
~240		25,800	51,600	75,500	99,300	123,200	146,300	170,200	194,000
~260		25,800	51,600	75,500	99,300	123,200	146,300	170,200	194,000
~280		29,700	59,300	87,000	114,700	142,400	170,200	197,900	225,600
約1.5倍ヒダ		~56	~120	~200	~266	~333	~400	~466	~533
フラット前1倍ヒダ		~80	~160	~260	~360	~460	~560		

形状記憶加工価格表 約2倍ヒダ (タッセル含む)

H	W	~44 1巾(片開き)	~100 2巾	~150 3巾	~200 4巾	~250 5巾	~300 6巾	~350 7巾	~400 8巾
~100		15,500	30,200	43,800	56,500	70,100	82,900	95,600	109,200
~120		19,800	39,500	56,500	74,400	91,400	109,200	126,200	144,100
~140		19,800	39,500	56,500	74,400	91,400	109,200	126,200	144,100
~160		19,800	39,500	56,500	74,400	91,400	109,200	126,200	144,100
~180		24,000	48,000	70,100	91,400	113,500	135,600	156,800	178,900
~200		24,000	48,000	70,100	91,400	113,500	135,600	156,800	178,900
~220		24,000	48,000	70,100	91,400	113,500	135,600	156,800	178,900
~240		28,300	56,500	82,900	109,200	135,600	161,100	187,400	213,800
~260		28,300	56,500	82,900	109,200	135,600	161,100	187,400	213,800

※片開きはW300cmまで

紀尾井

ソフト style no.501 **ロールソフト**

スプリング・チェーンタイプ

H	W	30~60	~80	~90
50~80		34,200	36,700	38,700
~120		37,900	41,000	43,000
~160		39,000	42,800	44,800
~200		43,800	46,800	49,000
~240			51,000	53,300

※丈は巾の3倍までが限度です。
 ※ロールソフト加工品は非防炎品になります。

TM-54166・54167

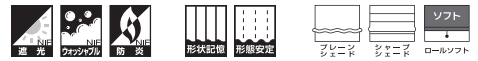

巾 ◇ 100cm 価格 ◇ 6,400円/m
組成 ◇ ポリエステル100%

リポート ◇ タテ 34.0cm ヨコ 33.3cm
寸法変化率 ◇ 水洗い/タテ -0.2% ヨコ -0.2%
ドライ/タテ -0.3% ヨコ 0.0%

取扱い表示 ◇ リ-30 30 40 50 60 70 80 90 100
防炎性能 ◇ (イ) あて布使用
Made in Japan

H	W	~44 1巾(片開き)	~100 2巾	~150 3巾	~200 4巾	~250 5巾	~300 6巾	~350 7巾	~400 8巾
~100		15,200	30,300	43,600	56,800	70,100	83,400	96,600	109,900
~120		15,200	30,300	43,600	56,800	70,100	83,400	96,600	109,900
~140		18,300	35,800	52,200	67,800	83,400	99,700	115,300	131,700
~160		18,300	35,800	52,200	67,800	83,400	99,700	115,300	131,700
~180		20,600	41,200	60,000	78,700	96,600	115,300	134,100	152,800
~200		20,600	41,200	60,000	78,700	96,600	115,300	134,100	152,800
~220		23,800	46,700	67,800	88,800	109,900	131,700	152,800	173,800
~240		26,100	52,200	75,600	99,700	123,100	147,300	171,500	194,900
~260		26,100	52,200	75,600	99,700	123,100	147,300	171,500	194,900
~280		28,400	56,800	83,400	109,900	136,400	162,900	189,400	216,000
約1.5倍ヒダ		~56	~120	~200	~266	~333	~400	~466	~533

※片開きはW270cmまで

H	W	~44 1巾(片開き)	~100 2巾	~150 3巾	~200 4巾	~250 5巾	~300 6巾	~350 7巾	~400 8巾
~100		15,500	31,000	44,600	58,200	71,800	85,400	99,000	112,600
~120		15,500	31,000	44,600	58,200	71,800	85,400	99,000	112,600
~140		18,700	36,600	53,400	69,400	85,400	102,200	118,200	135,000
~160		18,700	36,600	53,400	69,400	85,400	102,200	118,200	135,000
~180		21,100	42,200	61,400	80,600	99,000	118,200	137,400	156,600
~200		21,100	42,200	61,400	80,600	99,000	118,200	137,400	156,600
~220		24,300	47,800	69,400	91,000	112,600	135,000	156,600	178,200
~240		26,700	53,400	77,400	102,200	126,200	151,000	175,800	199,800
~260		26,700	53,400	77,400	102,200	126,200	151,000	175,800	199,800
~280		29,100	58,200	85,400	112,600	139,800	167,000	194,200	221,400
約1.5倍ヒダ		~56	~120	~200	~266	~333	~400	~466	~533

※片開きはW270cmまで

H	W	~44 1巾(片開き)	~100 2巾	~150 3巾	~200 4巾	~250 5巾	~300 6巾	~350 7巾	~400 8巾
~100		14,800	29,600	42,600	55,500	68,400	81,300	94,200	107,200
~120		14,800	29,600	42,600	55,500	68,400	81,300	94,200	107,200
~140		17,900	35,000	50,900	66,100	81,300	97,300	112,500	128,400
~160		17,900	35,000	50,900	66,100	81,300	97,300	112,500	128,400
~180		20,200	40,300	58,500	76,800	94,200	112,500	130,700	149,000
~200		20,200	40,300	58,500	76,800	94,200	112,500	130,700	149,000
~220		23,200	45,600	66,100	86,600	107,200	128,400	149,000	169,500
~240		25,500	50,900	73,700	97,300	120,100	143,600	167,200	190,000
~260		25,500	50,900	73,700	97,300	120,100	143,600	167,200	190,000
~280		27,800	55,500	81,300	107,200	133,000	158,800	184,700	210,500
約1.5倍ヒダ		~56	~120	~200	~266	~333	~400	~466	~533
フラット前ヒダ		~80	~160	~260	~360	~460	~560		

H	W	~44 1巾(片開き)	~100 2巾	~150 3巾	~200 4巾	~250 5巾	~300 6巾	~350 7巾	~400 8巾
~100		16,200	32,400	46,600	60,900	75,200	89,500	103,800	118,000
~120		16,200	32,400	46,600	60,900	75,200	89,500	103,800	118,000
~140		19,600	38,200	55,900	72,700	89,500	107,100	123,900	141,600
~160		19,600	38,200	55,900	72,700	89,500	107,100	123,900	141,600
~180		22,100	44,100	64,300	84,400	103,800	123,900	144,100	164,200
~200		22,100	44,100	64,300	84,400	103,800	123,900	144,100	164,200
~220		25,400	50,000	72,700	95,400	118,000	141,600	164,200	186,900
~240		28,000	55,900	81,100	107,100	132,300	158,400	184,400	209,600
~260		28,000	55,900	81,100	107,100	132,300	158,400	184,400	209,600

※片開きはW300cmまで

		コード式				ドラム式								
H	W	30~45	~90	~140	~190	~240	30~45	~90	~140	~190	~240	~290	~340	~390
50~100		17,900	21,900	34,100	38,000	49,600	20,900	24,900	37,100	41,000	52,600	60,200	72,700	77,500
~140		20,500	24,500	38,600	42,400	56,500	23,500	27,500	41,600	45,400	59,500	67,400	81,700	86,600
~180		23,600	27,600	43,600	47,400	63,800	26,600	30,600	46,600	50,400	66,800	75,000	91,000	96,000
~220		26,100	30,200	48,600	52,400	70,700	29,100	33,200	51,600	55,400	73,700	82,200	100,500	105,600
~260		30,900	35,000	57,500	61,200	82,800	33,900	38,000	60,500	64,200	85,800	94,700	117,200	122,200
~300		33,400	37,600	61,900	65,600	89,700	36,400	40,600	64,900	68,600	92,700	101,900	125,900	131,300

※ドラム式：仕上り巾39cm以下の場合、仕上り丈は200cmまでとなります。

		コード式
H	W	18~30
50~100		22,200
~140		25,300
~180		28,300
~220		31,300
~240		34,400

		コード式				ドラム式								
H	W	30~45	~90	~140	~190	~240	30~45	~90	~140	~190	~240	~290	~340	~390
50~100		20,800	27,100	41,700	48,400	62,200	23,800	30,100	44,700	51,400	65,200	73,400	88,000	94,600
~140		23,600	30,300	47,200	54,200	71,000	26,600	33,300	50,200	57,200	74,000	82,500	99,200	106,100
~180		26,900	34,000	53,100	60,700	80,300	29,900	37,000	56,100	63,700	83,300	92,200	111,300	118,600
~220		29,700	37,200	59,100	67,100	89,100	32,700	40,200	62,100	70,100	92,100	101,300	122,800	130,500
~260		34,900	43,000	69,500	78,100	104,300	37,900	46,000	72,500	81,100	107,300	117,000	143,000	151,200
~300		37,800	46,500	75,300	84,500	113,700	40,800	49,500	78,300	87,500	116,700	127,000	155,200	163,800

※ドラム式：仕上り巾39cm以下の場合、仕上り丈は200cmまでとなります。

		38mm (片開き/タッセルなし)				
H	W	~72	~100	~127	~155	~183
~100		28,600	30,700	44,900	47,000	59,200
~140		32,700	34,800	51,500	53,600	67,500
~180		36,900	39,000	57,400	59,500	75,800
~220		41,000	43,100	63,300	65,400	83,500
~260		45,200	47,300	69,200	71,300	91,800
~300		48,700	50,800	75,100	77,200	99,500
26mm		-2,800	-2,100	-4,900	-4,200	-4,900
18mm		-4,900	-5,600	-9,100	-9,800	-10,500

※生地を伸ばした状態のサイズでご発注ください。

		スプリング・チェーンタイプ	
H	W	30~60	~80
50~80		33,000	35,500
~120		35,700	38,800
~160		38,800	42,600
~200		42,500	45,500
~240			50,700

※丈は巾の3倍までが限度です。
※ロールソフト加工品は非防炎品になります。

		ストレートバランス				
H	W	~100	~150	~200	~250	~300
~40		16,000	20,400	28,400	32,800	40,800

※マジックテープ仕様・裏面スポンジ付の価格になります。

H	W	~100	~150	~200	~250	~300
~40		14,900	20,000	24,600	34,200	39,300

※マジックテープ仕様の価格になります。

TM-54168・54169

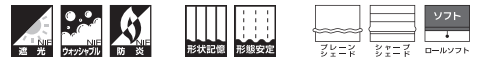

巾 ◇ 148 cm 価格 ◇ 5,900 円/m リポート ◇ タテ 23.5 cm ヨコ 9.9 cm 取扱い表示 ◇ リ-30 40 防炎性能 ◇ (イ) であて布使用
 組成 ◇ ポリエステル100% 寸法変化率 ◇ 水洗い/タテ -0.2% ヨコ -0.3% ドライ/タテ -0.2% ヨコ -0.2% Made in Japan

H	W	~65 1巾(片開き)	~148 2巾	~222 3巾	~296 4巾	~370 5巾	~444 6巾	~518 7巾
~100		13,800	26,700	37,900	49,000	60,200	71,400	82,600
~120		15,400	29,900	43,500	56,300	69,800	82,600	96,100
~140		17,000	33,900	49,000	64,100	78,500	93,700	108,800
~160		19,400	37,900	54,700	71,400	88,100	104,900	121,600
~180		21,000	41,100	60,200	78,500	97,700	116,100	135,100
~200		22,500	45,100	65,700	86,500	107,200	128,000	147,900
~220		22,500	45,100	65,700	86,500	107,200	128,000	147,900
~240		25,000	49,000	71,400	93,700	116,100	139,200	161,400
~260		26,600	53,100	76,900	101,700	125,500	150,200	174,200
~280		28,200	56,300	82,600	108,800	135,100	161,400	187,800
約1.5倍ヒダ		~86	~192	~296	~394	~493		

※片開きはW270cmまで

H	W	~65 1巾(片開き)	~148 2巾	~222 3巾	~296 4巾	~370 5巾	~444 6巾	~518 7巾
~100		14,200	27,600	39,200	50,700	62,300	73,900	85,500
~120		15,900	30,900	44,900	58,200	72,300	85,500	99,600
~140		17,500	35,000	50,700	66,400	81,300	97,000	112,700
~160		20,100	39,200	56,600	73,900	91,300	108,600	126,000
~180		21,700	42,500	62,300	81,300	101,200	120,200	140,000
~200		23,200	46,600	68,000	89,600	111,000	132,600	153,300
~220		23,200	46,600	68,000	89,600	111,000	132,600	153,300
~240		25,800	50,700	73,900	97,000	120,200	144,200	167,300
~260		27,500	54,900	79,600	105,300	130,000	155,700	180,600
~280		29,100	58,200	85,500	112,700	140,000	167,300	194,600
約1.5倍ヒダ		~86	~192	~296	~394	~493		

※片開きはW270cmまで

H	W	~65 1巾(片開き)	~148 2巾	~222 3巾	~296 4巾	~370 5巾	~444 6巾	~518 7巾	~592 8巾
~100		13,300	25,900	36,700	47,300	58,100	68,900	79,700	90,300
~120		14,900	29,000	42,000	54,300	67,300	79,700	92,700	104,900
~140		16,400	32,700	47,300	61,900	75,700	90,300	104,900	119,500
~160		18,800	36,700	52,800	68,900	85,000	101,100	117,200	134,100
~180		20,300	39,700	58,100	75,700	94,200	111,900	130,200	147,900
~200		21,700	43,500	63,400	83,400	103,300	123,400	142,600	162,500
~220		21,700	43,500	63,400	83,400	103,300	123,400	142,600	162,500
~240		24,100	47,300	68,900	90,300	111,900	134,100	155,600	177,000
~260		25,600	51,200	74,200	98,000	121,000	144,800	167,900	191,700
~280		27,200	54,300	79,700	104,900	130,200	155,600	180,900	206,300
約1.5倍ヒダ		~86	~192	~296	~394	~493	~592	~690	~789
フラット前ヒダ		~128	~256	~404	~552				

H	W	~65 1巾(片開き)	~148 2巾	~222 3巾	~296 4巾	~370 5巾	~444 6巾	~518 7巾	~592 8巾
~100		15,100	29,300	41,800	54,000	66,500	79,000	91,400	103,700
~120		16,900	32,900	47,900	62,100	77,200	91,400	106,400	120,500
~140		18,600	37,200	54,000	70,800	86,900	103,700	120,500	137,300
~160		21,400	41,800	60,400	79,000	97,500	116,100	134,700	154,300
~180		23,200	45,300	66,500	86,900	108,200	128,600	149,800	170,100
~200		24,800	49,700	72,600	95,800	118,700	141,800	164,000	186,900
~220		24,800	49,700	72,600	95,800	118,700	141,800	164,000	186,900
~240		27,500	54,000	79,000	103,700	128,600	154,300	179,000	203,700
~260		29,300	58,600	85,100	112,600	139,100	166,600	193,300	220,800

※片開きはW300cmまで

紀尾井

		コード式				ドラム式								
H	W	30~45	~90	~140	~240	30~45	~90	~140	~190	~240	~290	~340	~390	
50~100		17,800	21,800	33,500	37,300	42,000	20,800	24,800	36,500	40,300	45,000	59,500	64,300	69,000
~140		19,700	23,800	36,600	40,500	45,400	22,700	26,800	39,600	43,500	48,400	64,700	69,600	74,500
~180		23,200	27,200	42,900	46,700	51,800	26,200	30,200	45,900	49,700	54,800	73,300	78,300	83,300
~220		26,100	30,200	48,600	52,400	57,700	29,100	33,200	51,600	55,400	60,700	82,100	87,200	92,400
~260		28,500	32,600	52,300	56,100	61,600	31,500	35,600	55,300	59,100	64,600	87,100	92,600	97,600
~300		31,400	35,600	58,000	61,800	67,600	34,400	38,600	61,000	64,800	70,600	96,000	101,300	106,700

※ドラム式: 仕上り巾39cm以下の場合、仕上り丈は200cmまでとなります。

		コード式	
H	W	18~30	22,100
50~100		18~30	22,100
~140		24,600	
~180		27,900	
~220		31,300	
~240		32,300	

		コード式				ドラム式								
H	W	30~45	~90	~140	~240	30~45	~90	~140	~190	~240	~290	~340	~390	
50~100		20,700	27,000	41,000	47,600	54,000	23,700	30,000	44,000	50,600	57,000	72,600	79,200	85,700
~140		22,800	29,500	45,100	52,200	59,100	25,800	32,500	48,100	55,200	62,100	79,700	86,600	93,500
~180		26,500	33,600	52,300	59,900	67,400	29,500	36,600	53,300	62,900	70,400	90,500	98,000	105,300
~220		29,700	37,200	59,100	67,100	75,200	32,700	40,200	62,100	70,100	78,200	101,300	108,900	116,600
~260		32,400	40,600	64,100	72,700	81,500	35,400	43,600	67,100	75,700	84,500	109,200	117,300	125,500
~300		35,700	44,400	71,200	80,400	90,000	38,700	47,400	74,200	83,400	93,000	120,800	129,400	138,100

※ドラム式: 仕上り巾39cm以下の場合、仕上り丈は200cmまでとなります。

		38mm (片開き/タッセルなし)					
H	W	~72	~100	~127	~155	~183	
~100		17,300	27,700	31,900	34,000	44,400	
~140		19,700	33,000	37,200	39,300	52,600	
~180		22,700	38,300	42,500	44,600	60,900	
~220		23,800	41,300	45,500	47,600	65,000	
~260		26,800	47,200	51,400	53,500	73,300	
~300		29,700	52,500	56,700	58,800	81,500	
26mm		-2,800	-2,100	-4,900	-4,200	-4,900	
18mm		-4,900	-5,600	-9,100	-9,800	-10,500	

※生地を伸ばした状態のサイズでご発注ください。

		スプリング・チェーンタイプ				
H	W	30~60	~80	~100	~120	~138
50~80		32,900	35,400	37,400	38,600	40,300
~120		35,000	38,100	40,100	41,200	43,100
~160		38,400	42,200	44,200	45,400	46,700
~200		42,500	45,500	47,700	48,900	50,200
~240			48,500	50,800	52,000	53,400

※丈は巾の3倍までが限度です。
 ※ロールソフト加工品は非防炎品になります。

		ストレートバランス				
H	W	~100	~150	~200	~250	~300
~40		12,200	20,300	24,700	29,100	36,800

※マジックテープ仕様・裏面スポンジ付の価格になります。

		三ツ山・箱ヒダバランス (約2.5倍ヒダ)				
H	W	~100	~150	~200	~250	~300
~40		11,200	16,000	20,800	26,600	28,100

※マジックテープ仕様の価格になります。

TM-54170・54171



巾 ◇ 100cm 価格 ◇ 7,400円/m
組成 ◇ ポリエステル100%

リポート ◇ タテ 34.0cm ヨコ 33.3cm
寸法変化率 ◇ 水洗い/タテ -0.2% ヨコ 0.3%
ドライ/タテ 0.0% ヨコ 0.0%

取扱い表示 ◇ リ-30
防炎性能 ◇ (イ) あて布使用
Made in Japan

標準仕様 形態安定加工価格表 (約2倍ヒダ) (タッセル含む)

H	W	~44 1巾(片開き)	~100 2巾	~150 3巾	~200 4巾	~250 5巾	~300 6巾	~350 7巾	~400 8巾
~100	17,100	34,100	49,100	64,000	79,000	94,000	108,900	123,900	138,900
~120	17,100	34,100	49,100	64,000	79,000	94,000	108,900	123,900	138,900
~140	20,600	40,300	58,800	76,400	94,000	112,400	130,000	148,500	166,600
~160	20,600	40,300	58,800	76,400	94,000	112,400	130,000	148,500	166,600
~180	23,200	46,400	67,600	88,700	108,900	130,000	151,200	172,300	193,400
~200	23,200	46,400	67,600	88,700	108,900	130,000	151,200	172,300	193,400
~220	26,800	52,600	76,400	100,100	123,900	148,500	172,300	196,000	219,800
~240	29,400	58,800	85,200	112,400	138,800	166,100	193,400	219,800	243,600
~260	29,400	58,800	85,200	112,400	138,800	166,100	193,400	219,800	243,600
~280	32,000	64,000	94,000	123,900	153,800	183,700	213,600	243,600	287,200
約1.5倍ヒダ	~56	~120	~200	~266	~333	~400	~466	~533	

※片開きはW270cmまで

形態安定加工 推奨裏地付価格表(推奨裏地TM-54419~54423) (約2倍ヒダ) (タッセル含む)

H	W	~44 1巾(片開き)	~100 2巾	~150 3巾	~200 4巾	~250 5巾	~300 6巾	~350 7巾	~400 8巾
~100	23,200	46,300	61,300	82,300	103,400	118,400	139,400	160,500	181,600
~120	24,100	48,100	63,100	84,900	106,900	121,900	143,700	165,700	187,700
~140	28,500	56,000	74,500	99,900	125,400	143,800	169,200	195,500	221,800
~160	29,300	57,700	76,200	102,500	128,800	147,200	173,500	200,700	227,100
~180	32,800	65,600	86,800	117,500	147,200	168,300	199,100	229,800	260,500
~200	33,700	67,300	88,500	120,100	150,700	171,800	203,400	235,000	265,800
~220	38,200	75,300	99,100	134,100	169,200	193,800	228,900	263,900	293,900
~240	41,600	83,200	109,600	149,000	187,600	214,900	254,300	292,900	322,000
~260	42,500	84,900	111,300	151,600	191,000	218,300	258,700	298,100	327,200
~280	46,000	91,900	121,900	165,700	209,500	239,400	283,200	327,200	370,800
約1.5倍ヒダ	~56	~120	~200	~266	~333	~400	~466	~533	

※片開きはW270cmまで

プライム縫製仕様価格表 (約2倍ヒダ) (タッセル含む)

H	W	~44 1巾(片開き)	~100 2巾	~150 3巾	~200 4巾	~250 5巾	~300 6巾	~350 7巾	~400 8巾
~100	17,400	34,800	50,100	65,400	80,700	96,000	111,300	126,600	141,900
~120	17,400	34,800	50,100	65,400	80,700	96,000	111,300	126,600	141,900
~140	21,000	41,100	60,000	78,000	96,000	114,900	132,900	151,800	170,700
~160	21,000	41,100	60,000	78,000	96,000	114,900	132,900	151,800	170,700
~180	23,700	47,400	69,000	90,600	111,300	132,900	154,500	176,100	197,700
~200	23,700	47,400	69,000	90,600	111,300	132,900	154,500	176,100	197,700
~220	27,300	53,700	78,000	102,300	126,600	151,800	176,100	200,400	224,700
~240	30,000	60,000	87,000	114,900	141,900	169,800	197,700	224,700	258,700
~260	30,000	60,000	87,000	114,900	141,900	169,800	197,700	224,700	258,700
~280	32,700	65,400	96,000	126,600	157,200	187,800	218,400	249,000	280,000
約1.5倍ヒダ	~56	~120	~200	~266	~333	~400	~466	~533	

※片開きはW270cmまで

プライム縫製仕様 推奨裏地付価格表(推奨裏地TM-54419~54423) (約2倍ヒダ) (タッセル含む)

H	W	~44 1巾(片開き)	~100 2巾	~150 3巾	~200 4巾	~250 5巾	~300 6巾	~350 7巾	~400 8巾
~100	24,000	47,900	63,200	85,000	106,800	122,100	143,900	165,700	187,500
~120	24,900	49,700	65,000	87,800	110,500	125,800	148,500	171,300	193,100
~140	29,400	57,900	76,800	103,200	129,500	148,400	174,800	202,100	223,900
~160	30,300	59,700	78,600	105,900	133,200	152,100	179,400	207,600	229,400
~180	34,000	67,900	89,500	121,300	152,300	173,900	205,700	237,500	263,600
~200	34,900	69,800	91,400	124,100	156,000	177,600	210,300	243,100	269,100
~220	39,400	77,900	102,200	138,600	175,000	200,200	236,600	273,000	298,900
~240	43,100	86,100	113,100	154,000	194,000	221,900	262,800	302,900	328,700
~260	44,000	87,900	114,900	156,800	197,700	225,600	267,500	308,400	334,200
~280	47,600	95,200	125,800	171,300	216,800	247,400	292,800	338,300	370,800
約1.5倍ヒダ	~56	~120	~200	~266	~333	~400	~466	~533	

※片開きはW270cmまで

レギュラー縫製仕様価格表 (約2倍ヒダ) (タッセル含む)

H	W	~44 1巾(片開き)	~100 2巾	~150 3巾	~200 4巾	~250 5巾	~300 6巾	~350 7巾	~400 8巾
~100	16,700	33,400	48,100	62,700	77,300	91,900	106,500	121,200	135,900
~120	16,700	33,400	48,100	62,700	77,300	91,900	106,500	121,200	135,900
~140	20,200	39,500	57,500	74,700	91,900	110,000	127,200	145,200	163,200
~160	20,200	39,500	57,500	74,700	91,900	110,000	127,200	145,200	163,200
~180	22,800	45,500	66,100	86,800	106,500	127,200	147,800	168,500	189,200
~200	22,800	45,500	66,100	86,800	106,500	127,200	147,800	168,500	189,200
~220	26,200	51,500	74,700	97,900	121,200	145,200	168,500	191,700	216,000
~240	28,800	57,500	83,300	110,000	135,800	162,400	189,100	214,900	240,700
~260	28,800	57,500	83,300	110,000	135,800	162,400	189,100	214,900	240,700
~280	31,400	62,700	91,900	121,200	150,400	179,600	208,900	238,100	267,300
約1.5倍ヒダ	~56	~120	~200	~266	~333	~400	~466	~533	
フック付ヒダ	~80	~160	~260	~360	~460	~560			

形状記憶加工価格表 (約2倍ヒダ) (タッセル含む)

H	W	~44 1巾(片開き)	~100 2巾	~150 3巾	~200 4巾	~250 5巾	~300 6巾	~350 7巾	~400 8巾
~100	18,100	36,200	52,100	68,100	84,100	100,100	116,100	132,000	148,000
~120	18,100	36,200	52,100	68,100	84,100	100,100	116,100	132,000	148,000
~140	21,900	42,700	62,500	81,300	100,100	119,800	138,600	158,400	178,200
~160	21,900	42,700	62,500	81,300	100,100	119,800	138,600	158,400	178,200
~180	24,700	49,300	71,900	94,400	116,100	138,600	161,200	183,700	206,200
~200	24,700	49,300	71,900	94,400	116,100	138,600	161,200	183,700	206,200
~220	28,400	55,900	81,300	106,700	132,000	158,400	183,700	209,100	234,500
~240	31,300	62,500	90,700	119,800	148,000	177,200	206,300	234,500	263,700
~260	31,300	62,500	90,700	119,800	148,000	177,200	206,300	234,500	263,700

※片開きはW300cmまで

スリムシェード

H	W	コード式
50~100	18~30	23,300
~140	26,600	
~180	30,000	
~220	33,300	
~240	36,600	

ハトメカーテン 約1.8倍ヒダ

H	W	~72	~100	~127	~155	~183
~100	31,300	33,400	49,000	51,100	64,600	66,700
~140	36,000	38,100	56,400	58,500	74,100	76,200
~180	40,700	42,800	63,100	65,200	83,500	85,600
~220	45,400	47,500	69,900	72,000	92,200	94,300
~260	50,100	52,200	76,600	78,700	101,600	103,700
~300	54,100	56,200	83,300	85,400	110,300	112,400
26mm	-2,800	-2,100	-4,900	-4,200	-4,900	-4,200
18mm	-4,900	-5,600	-9,100	-9,800	-10,500	-11,200

※生地を伸ばした状態のサイズでご発注ください。

style no.60 プレーンシェード

H	W	コード式				ドラム式							
		30~45	~90	~140	~190	~240	30~45	~90	~140	~190	~240	~290	~340
50~100	19,200	23,100	36,600	40,300	53,100	22,200	26,100	39,600	43,300	56,100	63,700	77,400	82,200
~140	22,000	26,000	41,500	45,300	60,800	25,000	29,000	44,500	48,300	63,800	71,800	87,500	92,400
~180	25,400	29,400	47,100	50,900	69,000	28,400	32,400	50,100	53,900	72,000	80,300	98,000	103,100
~220	28,200	32,300	52,700	56,400	76,700	31,200	35,300	55,700	59,400	79,700	88,400	108,700	113,900
~260	33,600	37,600	62,800	66,400	90,600	36,600	40,600	65,800	69,400	93,600	102,600	127,800	132,800
~300	36,400	40,500	67,800	71,400	98,300	39,400	43,500	70,800	74,400	101,300	110,600	137,600	143,000

※ドラム式：仕上り巾39cm以下の場合、仕上り丈は200cmまでとなります。

style no.63 シャープシェード

H	W	コード式				ドラム式							
		30~45	~90	~140	~190	~240	30~45	~90	~140	~190	~240	~290	~340
50~100	22,000	28,300	44,300	50,900	65,900	25,000	31,300	47,300	53,900	68,900	77,100	93,000	99,500
~140	25,100	31,800	50,200	57,300	75,600	28,100	34,800	53,200	60,300	78,600	87,100	105,400	112,200
~180	28,800	35,900	56,800	64,400	85,900								

TM-54174~54176



巾 ◇ 150cm 価格 ◇ 5,500円/m
組成 ◇ ポリエステル100%

リポート ◇ タテ 24.0cm ヨコ 15.0cm
寸法変化率 ◇ 水洗い/タテ 0.0% ヨコ 0.2%
ドライ/タテ 0.0% ヨコ -0.2%

取扱い表示 ◇ リ-30
防炎性能 ◇ (イ) あて布使用
Made in Japan

標準仕様 形態安定加工価格表 約2倍ヒダ (タッセル含む)

H	W	~67	~150	~225	~300	~375	~450	~525
		1巾(片開き)	2巾	3巾	4巾	5巾	6巾	7巾
~100		13,200	25,600	36,900	47,500	58,200	69,600	80,300
~120		14,700	29,300	42,300	55,100	67,300	80,300	93,100
~140		16,900	33,200	47,500	62,000	76,400	91,600	106,100
~160		18,500	36,900	52,900	69,600	85,500	102,200	119,000
~180		20,000	39,900	58,200	76,400	94,600	112,900	131,100
~200		20,000	39,900	58,200	76,400	94,600	112,900	131,100
~220		22,300	43,800	64,200	84,000	103,800	124,400	144,100
~240		23,900	47,500	69,600	91,600	112,900	135,000	157,000
~260		26,100	51,400	74,900	98,500	122,000	146,300	170,000
~280		27,600	55,100	80,300	106,100	131,100	157,000	182,800
約1.5倍ヒダ		~88	~200	~300	~400	~500		

※片開きはW270cmまで

プライム縫製仕様価格表 約2倍ヒダ (タッセル含む)

H	W	~67	~150	~225	~300	~375	~450	~525
		1巾(片開き)	2巾	3巾	4巾	5巾	6巾	7巾
~100		13,700	26,400	38,200	49,300	60,300	72,300	83,300
~120		15,300	30,300	43,800	57,200	69,800	83,300	96,700
~140		17,500	34,300	49,300	64,400	79,300	95,100	110,200
~160		19,100	38,200	54,900	72,300	88,800	106,100	123,500
~180		20,700	41,400	60,300	79,300	98,200	117,200	136,200
~200		20,700	41,400	60,300	79,300	98,200	117,200	136,200
~220		23,200	45,400	66,600	87,200	107,700	129,100	149,700
~240		24,700	49,300	72,300	95,100	117,200	140,200	163,000
~260		27,000	53,300	77,700	102,300	126,700	152,000	176,500
~280		28,600	57,200	83,300	110,200	136,200	163,000	189,900
約1.5倍ヒダ		~88	~200	~300	~400	~500		

※片開きはW270cmまで

レギュラー縫製仕様価格表 約2倍ヒダ (タッセル含む)

H	W	~67	~150	~225	~300	~375	~450	~525	~600
		1巾(片開き)	2巾	3巾	4巾	5巾	6巾	7巾	8巾
~100		12,800	24,700	35,600	45,800	56,000	67,000	77,200	88,100
~120		14,200	28,300	40,700	53,100	64,800	77,200	89,600	102,100
~140		16,300	32,000	45,800	59,700	73,500	88,100	102,100	115,900
~160		17,800	35,600	51,000	67,000	82,300	98,300	114,400	129,800
~180		19,300	38,500	56,000	73,500	91,000	108,600	126,100	143,600
~200		19,300	38,500	56,000	73,500	91,000	108,600	126,100	143,600
~220		21,500	42,200	61,800	80,800	99,800	119,600	138,600	158,200
~240		23,000	45,800	67,000	88,100	108,600	129,800	150,900	172,100
~260		25,100	49,500	72,100	94,800	117,300	140,700	163,400	185,900
~280		26,600	53,100	77,200	102,100	126,100	150,900	175,700	199,900
約1.5倍ヒダ		~88	~200	~300	~400	~500	~600	~700	~800
フラット前ヒダ		~130	~260	~410	~560				

形態安定加工 推奨裏地付価格表(推奨裏地TM-54419~54423) 約2倍ヒダ (タッセル含む)

H	W	~67	~150	~225	~300	~375	~450	~525
		1巾(片開き)	2巾	3巾	4巾	5巾	6巾	7巾
~100		19,300	37,800	55,200	71,900	88,700	106,200	123,000
~120		21,700	43,300	63,200	83,000	102,100	122,100	141,900
~140		24,800	48,900	71,000	93,400	115,600	138,600	161,000
~160		27,200	54,300	79,000	104,400	129,000	154,400	179,900
~180		29,600	59,100	87,000	114,700	142,500	170,400	198,100
~200		30,500	60,800	89,600	118,200	146,800	175,600	204,200
~220		33,700	66,500	98,200	129,300	160,400	192,300	223,300
~240		36,100	71,900	106,200	140,400	173,800	208,100	242,300
~260		39,200	77,500	114,100	150,700	187,300	224,600	261,400
~280		41,600	83,000	122,100	161,800	200,700	240,600	280,300
約1.5倍ヒダ		~88	~200	~300	~400	~500		

※片開きはW270cmまで

プライム縫製仕様 推奨裏地付価格表(推奨裏地TM-54419~54423) 約2倍ヒダ (タッセル含む)

H	W	~67	~150	~225	~300	~375	~450	~525
		1巾(片開き)	2巾	3巾	4巾	5巾	6巾	7巾
~100		20,300	39,500	57,800	75,400	92,900	111,400	128,900
~120		22,800	45,200	66,200	87,000	107,000	128,000	148,800
~140		25,900	51,100	74,500	97,900	121,200	145,400	168,800
~160		28,400	56,800	82,800	109,500	135,300	161,900	188,600
~180		31,000	61,900	91,000	120,300	149,400	178,600	207,900
~200		31,900	63,800	93,800	124,000	154,000	184,200	214,400
~220		35,300	69,600	102,900	135,600	168,200	201,700	234,400
~240		37,800	75,400	111,400	147,200	182,300	218,400	254,200
~260		41,000	81,200	119,600	158,100	196,500	235,700	274,200
~280		43,500	87,000	128,000	169,800	210,600	252,300	294,100
約1.5倍ヒダ		~88	~200	~300	~400	~500		

※片開きはW270cmまで

レギュラー縫製仕様 推奨裏地付価格表(推奨裏地TM-54419~54423) 約2倍ヒダ (タッセル含む)

H	W	~67	~150	~225	~300	~375	~450	~525	~600
		1巾(片開き)	2巾	3巾	4巾	5巾	6巾	7巾	8巾
~100		18,500	36,100	52,700	68,500	84,400	101,100	116,900	133,500
~120		20,700	41,300	60,200	79,100	97,200	116,100	135,000	154,000
~140		23,600	46,600	67,700	88,900	110,000	131,900	153,200	174,300
~160		25,900	51,800	75,300	99,400	122,800	146,900	171,100	194,600
~180		28,300	56,400	82,800	109,200	135,600	162,100	188,500	214,900
~200		29,100	58,000	85,200	112,400	139,600	167,000	194,200	221,400
~220		32,100	63,300	93,400	123,000	152,500	182,800	212,400	242,500
~240		34,400	68,500	101,100	133,500	165,300	197,900	230,300	262,900
~260		37,300	73,800	108,600	143,400	178,100	213,600	248,500	283,100
~280		39,600	79,100	116,100	154,000	190,900	228,700	266,500	303,600
約1.5倍ヒダ		~88	~200	~300	~400	~500	~600	~700	~800

style no.60 プレーンシェード

H	W	コード式				ドラム式								
		30~45	~90	~140	~190	~240	30~45	~90	~140	~190	~240	~290	~340	~390
50~100		15,900	19,900	24,400	34,000	38,700	18,900	22,900	27,400	37,000	41,700	49,000	59,500	64,300
~140		19,200	23,200	27,900	39,900	44,800	22,200	26,200	30,900	42,900	47,800	55,400	68,400	73,300
~180		22,400	26,400	31,400	45,700	50,800	25,400	29,400	34,400	48,700	53,800	61,700	76,600	81,600
~220		24,200	28,300	33,500	48,800	54,100	27,200	31,300	36,500	51,800	57,100	65,200	81,700	86,800
~260		27,500	31,600	37,100	54,600	60,200	30,500	34,600	40,100	57,600	63,200	71,500	90,600	95,600
~300		30,700	35,000	40,600	60,500	66,300	33,700	38,000	43,600	63,500	69,300	77,900	98,900	104,200

※ドラム式: 仕上り巾39cm以下の場合、仕上り巾は200cmまでとなります。

style no.63 シャープシェード

H	W	コード式				ドラム式								
		30~45	~90	~140	~190	~240	30~45	~90	~140	~190	~240	~290	~340	~390
50~100		18,700	24,900	31,600	44,100	50,500	21,700	27,900	34,600	47,100	53,500	61,600	74,200	80,700
~140		22,200	28,900	36,000	51,500	58,400	25,200	31,900	39,000	54,500	61,400	70,000	85,300	92,200
~180		25,700	32,800	40,400	58,800	66,400	28,700	35,800	43,400	61,800	69,400	78,300	96,200	103,500
~220		27,700	35,300	43,300	63,200	71,400	30,700	38,300	46,300	66,200	74,400	83,600	103,200	110,800
~260		31,400	39,500	48,200	71,100	80,000	34,400	42,500	51,200	74,100	83,000	92,700	115,300	123,400
~300		35,000	43,700	53,000	79,000	88,600	38,000	46,700	56,000	82,000	91,600	101,900	126,900	135,500

※ドラム式: 仕上り巾39cm以下の場合、仕上り巾は200cmまでとなります。

ハトメカーテン 約1.8倍ヒダ

H	W	(片開き/タッセルなし)				
		~72	~100	~127	~155	~183
~100		16,900	26,800	31,000	33,100	43,600
~140		19,600	32,400	36,600	38,700	51,400
~180		21,900	37,400	41,600	43,700	59,300
~220		23,600	40,300	44,500	46,600	63,700
~260		26,400	45,900	50,100	52,200	71,600
~300		28,600	50,900	55,100	57,200	79,400
26mm		-2,800	-2,100	-4,900	-4,200	-4,900
18mm		-4,900	-5,600	-9,100	-9,800	-10,500

TM-54181・54182



巾 ◇ 148 cm 価格 ◇ 4,800円/m リポート ◇ タテ 24.0 cm ヨコ 14.8 cm 取扱い表示 ◇ リ-30 防炎性能 ◇ (イ) であって使用
 組成 ◇ ポリエステル100% 寸法変化率 ◇ 水洗い/タテ -0.5% ヨコ 0.0% ドライ/タテ 0.0% ヨコ 0.0% Made in Japan

標準仕様 形態安定加工価格表 約2倍ヒダ (タッセル含む)

H	W	~65 1巾(片開き)	~148 2巾	~222 3巾	~296 4巾	~370 5巾	~444 6巾	~518 7巾
~100		11,900	23,100	33,400	43,000	52,700	63,000	72,500
~120		13,300	26,500	38,100	49,900	60,800	72,500	84,300
~140		15,400	30,000	43,000	56,100	69,100	82,900	96,000
~160		16,800	33,400	47,800	63,000	77,400	92,400	107,600
~180		18,200	36,100	52,700	69,100	85,700	102,100	118,700
~200		18,200	36,100	52,700	69,100	85,700	102,100	118,700
~220		20,200	39,500	58,100	76,000	93,800	112,400	130,300
~240		21,500	43,000	63,000	82,900	102,100	122,000	142,000
~260		23,500	46,400	67,700	89,100	110,400	132,300	153,600
~280		24,900	49,900	72,500	96,000	118,700	142,000	165,300
約1.5倍ヒダ		~86	~192	~296	~394	~493		

※片開きはW270cmまで

プライム縫製仕様価格表 約2倍ヒダ (タッセル含む)

H	W	~65 1巾(片開き)	~148 2巾	~222 3巾	~296 4巾	~370 5巾	~444 6巾	~518 7巾
~100		12,300	24,000	34,700	44,800	54,800	65,600	75,500
~120		13,800	27,500	39,600	52,000	63,300	75,500	87,800
~140		16,000	31,200	44,800	58,400	72,000	86,400	100,000
~160		17,400	34,700	49,700	65,600	80,600	96,300	112,100
~180		18,900	37,600	54,800	72,000	89,200	106,400	123,600
~200		18,900	37,600	54,800	72,000	89,200	106,400	123,600
~220		21,000	41,100	60,400	79,200	97,700	117,100	135,800
~240		22,400	44,800	65,600	86,400	106,400	127,200	148,000
~260		24,500	48,300	70,500	92,800	115,000	137,900	160,100
~280		25,900	52,000	75,500	100,000	123,600	148,000	172,300
約1.5倍ヒダ		~86	~192	~296	~394	~493		

※片開きはW270cmまで

レギュラー縫製仕様価格表 約2倍ヒダ (タッセル含む)

H	W	~65 1巾(片開き)	~148 2巾	~222 3巾	~296 4巾	~370 5巾	~444 6巾	~518 7巾	~592 8巾
~100		11,400	22,200	32,100	41,300	50,600	60,400	69,500	79,500
~120		12,800	25,500	36,600	47,900	58,400	69,500	80,800	92,000
~140		14,800	28,800	41,300	53,800	66,300	79,500	92,000	104,400
~160		16,100	32,100	45,900	60,400	74,200	88,600	103,100	116,900
~180		17,400	34,700	50,600	66,300	82,100	97,800	113,700	129,400
~200		17,400	34,700	50,600	66,300	82,100	97,800	113,700	129,400
~220		19,400	38,000	55,700	72,900	89,900	107,700	124,800	142,600
~240		20,700	41,300	60,400	79,500	97,800	116,900	136,000	155,100
~260		22,600	44,600	65,000	85,400	105,800	126,800	147,200	167,600
~280		23,900	47,900	69,500	92,000	113,700	136,000	158,300	180,000
約1.5倍ヒダ		~86	~192	~296	~394	~493	~592	~690	~789
フラット約1倍ヒダ		~128	~256	~404	~552				

形状記憶加工価格表 約2倍ヒダ (タッセル含む)

H	W	~65 1巾(片開き)	~148 2巾	~222 3巾	~296 4巾	~370 5巾	~444 6巾	~518 7巾	~592 8巾
~100		13,200	25,700	37,300	48,200	59,100	70,700	81,400	93,200
~120		14,800	29,500	42,600	56,000	68,300	81,400	94,800	108,000
~140		17,200	33,500	48,200	62,900	77,600	93,200	108,000	122,700
~160		18,800	37,300	53,600	70,700	87,000	104,000	121,100	137,400
~180		20,300	40,400	59,100	77,600	96,400	114,900	133,600	152,100
~200		20,300	40,400	59,100	77,600	96,400	114,900	133,600	152,100
~220		22,600	44,200	65,200	85,400	105,500	126,500	146,800	167,700
~240		24,100	48,200	70,700	93,200	114,900	137,400	159,900	182,400
~260		26,400	52,000	76,100	100,200	124,200	149,000	173,100	197,200

※片開きはW300cmまで

style no.60 プレーンシェード

H	W	コード式					ドラム式							
		30~45	~90	~140	~190	~240	30~45	~90	~140	~190	~240	~290	~340	~390
50~100		15,100	19,100	28,600	32,600	37,300	18,100	22,100	31,600	35,600	40,300	52,500	57,300	62,100
~140		18,100	22,200	33,900	37,900	42,800	21,100	25,200	36,900	40,900	45,800	60,400	65,300	70,200
~180		21,000	25,100	39,200	43,100	48,200	24,000	28,100	42,200	46,100	51,200	67,700	72,700	77,700
~220		22,800	26,900	42,000	46,000	51,300	25,800	29,900	45,000	49,000	54,300	72,300	77,400	82,500
~260		25,700	29,900	47,300	51,200	56,800	28,700	32,900	50,300	54,200	59,800	79,900	85,400	90,400
~300		28,600	32,900	52,600	56,500	62,300	31,600	35,900	55,600	59,500	65,300	87,400	92,800	98,100

※ドラム式:仕上り巾39cm以下の場合、仕上り巾は200cmまでとなります。

style no.63 シャープシェード

H	W	コード式					ドラム式							
		30~45	~90	~140	~190	~240	30~45	~90	~140	~190	~240	~290	~340	~390
50~100		17,900	24,200	36,000	42,600	49,000	20,900	27,200	39,000	45,600	52,000	65,300	71,900	78,500
~140		21,100	27,800	42,300	49,300	56,300	24,100	30,800	45,300	52,300	59,300	75,200	82,100	88,900
~180		24,300	31,500	48,500	56,100	63,600	27,300	34,500	51,500	59,100	66,600	84,600	92,100	99,400
~220		26,200	33,800	52,200	60,200	68,300	29,200	36,800	55,200	63,200	71,300	91,000	98,600	106,300
~260		29,500	37,700	58,900	67,500	76,300	32,500	40,700	61,900	70,500	79,300	101,600	109,800	117,900
~300		32,900	41,600	65,500	74,800	84,300	35,900	44,600	68,500	77,800	87,300	111,800	120,500	129,100

※ドラム式:仕上り巾39cm以下の場合、仕上り巾は200cmまでとなります。

形態安定加工 推奨裏地付価格表(推奨裏地 TM-54419~54423) 約2倍ヒダ (タッセル含む)

H	W	~65 1巾(片開き)	~148 2巾	~222 3巾	~296 4巾	~370 5巾	~444 6巾	~518 7巾
~100		18,000	35,300	51,700	67,400	83,200	99,600	115,200
~120		20,300	40,500	59,000	77,800	95,600	114,300	133,100
~140		23,300	45,700	66,500	87,500	108,300	129,900	150,900
~160		25,500	50,800	73,900	97,800	120,900	144,600	168,500
~180		27,800	55,300	81,500	107,400	133,600	159,600	185,700
~200		28,700	57,000	84,100	110,900	137,900	164,800	191,800
~220		31,600	62,200	92,100	121,300	150,400	180,300	209,500
~240		33,700	67,400	99,600	131,700	163,000	195,100	227,300
~260		36,600	72,500	106,900	141,300	175,700	210,600	245,000
~280		38,900	77,800	114,300	151,700	188,300	225,600	262,800
約1.5倍ヒダ		~86	~192	~296	~394	~493		

※片開きはW270cmまで

プライム縫製仕様 推奨裏地付価格表(推奨裏地 TM-54419~54423) 約2倍ヒダ (タッセル含む)

H	W	~65 1巾(片開き)	~148 2巾	~222 3巾	~296 4巾	~370 5巾	~444 6巾	~518 7巾
~100		18,900	37,100	54,300	70,900	87,400	104,700	121,100
~120		21,300	42,400	62,000	81,800	100,500	120,200	139,900
~140		24,400	48,000	70,000	91,900	113,900	136,700	158,600
~160		26,700	53,300	77,600	102,800	127,100	152,100	177,200
~180		29,200	58,100	85,500	113,000	140,400	167,800	195,300
~200		30,100	60,000	88,300	116,700	145,000	173,400	201,800
~220		33,100	65,300	96,700	127,600	158,200	189,700	220,500
~240		35,500	70,900	104,700	138,500	171,500	205,400	239,200
~260		38,500	76,200	112,400	148,600	184,800	221,600	257,800
~280		40,800	81,800	120,200	159,600	198,000	237,300	276,500
約1.5倍ヒダ		~86	~192	~296	~394	~493		

※片開きはW270cmまで

レギュラー縫製仕様 推奨裏地付価格表(推奨裏地 TM-54419~54423) 約2倍ヒダ (タッセル含む)

H	W	~65 1巾(片開き)	~148 2巾	~222 3巾	~296 4巾	~370 5巾	~444 6巾	~518 7巾	~592 8巾
~100		17,100	33,600	49,200	64,000	79,000	94,500	109,200	124,900
~120		19,300	38,500	56,100	73,900	90,800	108,400	126,200	143,900
~140		22,100	43,400	63,200	83,000	102,800	123,300	143,100	162,800
~160		24,200	48,300	70,200	92,800	114,700	137,200	159,800	181,700
~180		26,400	52,600	77,400	102,000	126,700	151,300	176,100	200,700
~200		27,200	54,200	79,800	105,200	130,700	156,200	181,800	207,200
~220		30,000	59,100	87,300	115,100	142,600	170,900	198,600	226,900
~240		32,100	64,000	94,500	124,900	154,500	185,000	215,400	245,900
~260		34,800	68,900	101,500	134,000	166,600	199,700	232,300	264,800
~280		36,900	73,900	108,400					

TM-54183



巾 ◇ 149 cm 価格 ◇ 5,600 円/m
組成 ◇ ポリエステル100%

リポート ◇ タテ 49.5 cm ヨコ 49.7 cm
寸法変化率 ◇ 水洗い/タテ 0.0% ヨコ 0.0%
ドライ/タテ 0.0% ヨコ 0.0%

取扱い表示 ◇ リ-30 40 30 30 30 30 30 30
防炎性能 ◇ ー
Made in Japan

H	W	~66 1巾(片開き)	~149 2巾	~223 3巾	~298 4巾	~372 5巾	~447 6巾	~521 7巾
~100		13,200	26,600	38,100	49,500	61,200	72,600	83,400
~120		17,200	34,300	49,500	64,900	79,600	94,900	110,300
~140		17,200	34,300	49,500	64,900	79,600	94,900	110,300
~160		17,200	34,300	49,500	64,900	79,600	94,900	110,300
~180		20,900	42,000	61,200	79,600	98,800	118,000	137,200
~200		20,900	42,000	61,200	79,600	98,800	118,000	137,200
~220		24,900	49,500	72,600	94,900	118,000	141,100	163,400
~240		24,900	49,500	72,600	94,900	118,000	141,100	163,400
~260		24,900	49,500	72,600	94,900	118,000	141,100	163,400
~280		28,600	57,200	83,400	110,300	137,200	163,400	190,200
約1.5倍ヒダ		~87	~194	~298	~397	~496		

※片開きはW270cmまで

H	W	~66 1巾(片開き)	~149 2巾	~223 3巾	~298 4巾	~372 5巾	~447 6巾	~521 7巾
~100		13,700	27,500	39,400	51,300	63,400	75,300	86,500
~120		17,800	35,500	51,300	67,300	82,600	98,400	114,400
~140		17,800	35,500	51,300	67,300	82,600	98,400	114,400
~160		17,800	35,500	51,300	67,300	82,600	98,400	114,400
~180		21,700	43,500	63,400	82,600	102,500	122,400	142,400
~200		21,700	43,500	63,400	82,600	102,500	122,400	142,400
~220		25,800	51,300	75,300	98,400	122,400	146,400	169,600
~240		25,800	51,300	75,300	98,400	122,400	146,400	169,600
~260		25,800	51,300	75,300	98,400	122,400	146,400	169,600
~280		29,700	59,300	86,500	114,400	142,400	169,600	197,500
約1.5倍ヒダ		~87	~194	~298	~397	~496		

※片開きはW270cmまで

H	W	~66 1巾(片開き)	~149 2巾	~223 3巾	~298 4巾	~372 5巾	~447 6巾	~521 7巾	~596 8巾
~100		12,800	25,700	36,700	47,800	58,900	70,000	80,300	91,400
~120		16,600	33,100	47,800	62,600	76,700	91,400	106,200	121,000
~140		16,600	33,100	47,800	62,600	76,700	91,400	106,200	121,000
~160		16,600	33,100	47,800	62,600	76,700	91,400	106,200	121,000
~180		20,200	40,500	58,900	76,700	95,100	113,600	132,000	149,800
~200		20,200	40,500	58,900	76,700	95,100	113,600	132,000	149,800
~220		24,000	47,800	70,000	91,400	113,600	135,800	157,200	179,400
~240		24,000	47,800	70,000	91,400	113,600	135,800	157,200	179,400
~260		24,000	47,800	70,000	91,400	113,600	135,800	157,200	179,400
~280		27,600	55,200	80,300	106,200	132,000	157,200	183,000	208,800
約1.5倍ヒダ		~87	~194	~298	~397	~496	~596	~695	~794
フラット前ヒダ		~129	~258	~407	~556				

H	W	~66 1巾(片開き)	~149 2巾	~223 3巾	~298 4巾	~372 5巾	~447 6巾	~521 7巾	~596 8巾
~100		14,600	29,300	42,100	54,900	67,900	80,700	92,700	105,500
~120		19,000	37,900	54,900	72,100	88,500	105,500	122,700	139,900
~140		19,000	37,900	54,900	72,100	88,500	105,500	122,700	139,900
~160		19,000	37,900	54,900	72,100	88,500	105,500	122,700	139,900
~180		23,200	46,500	67,900	88,500	109,900	131,300	152,700	173,400
~200		23,200	46,500	67,900	88,500	109,900	131,300	152,700	173,400
~220		27,600	54,900	80,700	105,500	131,300	157,100	182,000	207,800
~240		27,600	54,900	80,700	105,500	131,300	157,100	182,000	207,800
~260		27,600	54,900	80,700	105,500	131,300	157,100	182,000	207,800

※片開きはW300cmまで

		コード式				ドラム式								
H	W	30~45	~90	~140	~190	~240	30~45	~90	~140	~190	~240	~290	~340	~390
50~100		17,400	21,400	33,200	37,000	41,700	20,400	24,400	36,200	40,000	44,700	59,300	64,100	68,900
~140		20,800	24,800	39,200	43,000	47,900	23,800	27,800	42,200	46,000	50,900	68,300	73,200	78,100
~180		21,600	25,700	40,300	44,200	49,300	24,600	28,700	43,300	47,200	52,300	69,700	74,800	79,800
~220		24,900	29,000	46,300	50,100	55,500	27,900	32,000	49,300	53,100	58,500	78,700	83,800	88,900
~260		28,200	32,400	52,200	56,100	61,600	31,200	35,400	55,200	59,100	64,600	87,400	92,800	97,800
~300		31,500	35,700	58,200	62,000	67,800	34,500	38,700	61,200	65,000	70,800	95,800	101,200	106,500

※ドラム式: 仕上り巾39cm以下の場合、仕上り丈は200cmまでとなります。

		コード式
H	W	18~30
50~100		21,800
~140		25,500
~180		26,500
~220		30,200
~240		33,500

		コード式				ドラム式								
H	W	30~45	~90	~140	~190	~240	30~45	~90	~140	~190	~240	~290	~340	~390
50~100		20,300	26,600	40,700	47,300	53,700	23,300	29,600	43,700	50,300	56,700	72,400	79,000	85,600
~140		23,900	30,600	47,700	54,800	61,800	26,900	33,600	50,700	57,800	64,800	83,400	90,300	97,200
~180		24,900	32,000	49,600	57,200	64,800	27,900	35,000	52,600	60,200	67,800	86,700	94,300	101,600
~220		28,500	36,000	56,600	64,700	72,800	31,500	39,000	59,600	67,700	75,800	97,700	105,300	113,000
~260		32,100	40,300	64,000	72,700	81,500	35,100	43,300	67,000	75,700	84,500	109,400	117,500	125,700
~300		35,900	44,500	71,400	80,700	90,200	38,900	47,500	74,400	83,700	93,200	120,600	129,300	137,900

※ドラム式: 仕上り巾39cm以下の場合、仕上り丈は200cmまでとなります。

		スプリング・チェーンタイプ				
H	W	30~60	~80	~100	~120	~139
50~80		32,600	35,100	37,100	38,300	40,000
~120		35,900	39,000	41,000	42,100	44,000
~160		37,000	40,800	42,800	44,000	45,300
~200		41,400	44,400	46,600	47,800	49,100
~240			48,300	50,600	51,800	53,200

※丈は巾の3倍までが限度です。

		38mm (片開き/タッセルなし)				
H	W	~72	~100	~127	~155	~183
~100		16,900	27,600	31,800	33,900	44,500
~140		19,800	33,300	37,500	39,600	52,900
~180		22,600	38,900	43,100	45,200	61,500
~220		25,500	44,500	48,700	50,800	70,000
~260		25,500	44,500	48,700	50,800	70,000
~300		28,300	50,200	54,400	56,500	77,900
26mm		-2,800	-2,100	-4,900	-4,200	-4,900
18mm		-4,900	-5,600	-9,100	-9,800	-10,500

※生地を伸ばした状態のサイズでご発注ください。

		ストレートバランス				
H	W	~100	~150	~200	~250	~300
~40		13,300	22,200	26,600	31,000	39,900

※マジックテープ仕様・裏面スポンジ付の価格になります。

H	W	~100	~150	~200	~250	~300
~40		13,100	19,100	25,100	32,000	33,500

※マジックテープ仕様の価格になります。

遮光

TM-54187・54188



巾 ◇ 148cm 価格 ◇ 6,500円/m
組成 ◇ ポリエステル100%

リポート ◇ タテ 49.5cm ヨコ 29.6cm
寸法変化率 ◇ 水洗い/タテ -0.4% ヨコ 0.0%
ドライ/タテ -0.4% ヨコ 0.0%

取扱い表示 ◇ リ-30 30 40 50 60 70 80 90 100
防炎性能 ◇ (イ) あて布使用
Made in Japan

H	W	~65 1巾(片開き)	~148 2巾	~222 3巾	~296 4巾	~370 5巾	~444 6巾	~518 7巾
~100		14,800	29,500	42,500	55,300	68,100	81,000	93,000
~120		19,100	38,100	55,300	72,400	88,800	105,800	123,000
~140		19,100	38,100	55,300	72,400	88,800	105,800	123,000
~160		19,100	38,100	55,300	72,400	88,800	105,800	123,000
~180		23,400	46,700	68,100	88,800	110,200	131,600	153,100
~200		23,400	46,700	68,100	88,800	110,200	131,600	153,100
~220		27,600	55,300	81,000	105,800	131,600	157,300	182,200
~240		27,600	55,300	81,000	105,800	131,600	157,300	182,200
~260		27,600	55,300	81,000	105,800	131,600	157,300	182,200
~280		32,000	63,900	93,000	123,000	153,100	182,200	212,200
約1.5倍ヒダ		~86	~192	~296	~394	~493		

※片開きはW270cmまで

H	W	~65 1巾(片開き)	~148 2巾	~222 3巾	~296 4巾	~370 5巾	~444 6巾	~518 7巾
~100		15,200	30,400	43,800	57,100	70,400	83,600	96,100
~120		19,700	39,300	57,100	74,700	91,700	109,400	127,200
~140		19,700	39,300	57,100	74,700	91,700	109,400	127,200
~160		19,700	39,300	57,100	74,700	91,700	109,400	127,200
~180		24,100	48,200	70,400	91,700	113,900	136,100	158,200
~200		24,100	48,200	70,400	91,700	113,900	136,100	158,200
~220		28,500	57,100	83,600	109,400	136,100	162,600	188,300
~240		28,500	57,100	83,600	109,400	136,100	162,600	188,300
~260		28,500	57,100	83,600	109,400	136,100	162,600	188,300
~280		33,000	66,000	96,100	127,200	158,200	188,300	219,400
約1.5倍ヒダ		~86	~192	~296	~394	~493		

※片開きはW270cmまで

H	W	~65 1巾(片開き)	~148 2巾	~222 3巾	~296 4巾	~370 5巾	~444 6巾	~518 7巾	~592 8巾
~100		14,300	28,600	41,100	53,500	65,900	78,300	89,900	102,300
~120		18,500	36,900	53,500	70,000	85,800	102,300	118,900	135,400
~140		18,500	36,900	53,500	70,000	85,800	102,300	118,900	135,400
~160		18,500	36,900	53,500	70,000	85,800	102,300	118,900	135,400
~180		22,600	45,200	65,900	85,800	106,500	127,200	147,900	167,700
~200		22,600	45,200	65,900	85,800	106,500	127,200	147,900	167,700
~220		26,700	53,500	78,300	102,300	127,200	152,000	176,000	200,800
~240		26,700	53,500	78,300	102,300	127,200	152,000	176,000	200,800
~260		26,700	53,500	78,300	102,300	127,200	152,000	176,000	200,800
~280		30,900	61,800	89,900	118,900	147,900	176,000	205,000	233,900
約1.5倍ヒダ		~86	~192	~296	~394	~493	~592	~690	~789
フラット前ヒダ		~128	~256	~404	~552				

H	W	~65 1巾(片開き)	~148 2巾	~222 3巾	~296 4巾	~370 5巾	~444 6巾	~518 7巾	~592 8巾
~100		16,100	32,100	46,500	60,600	74,800	88,900	102,200	116,400
~120		20,900	41,600	60,600	79,400	97,600	116,400	135,400	154,200
~140		20,900	41,600	60,600	79,400	97,600	116,400	135,400	154,200
~160		20,900	41,600	60,600	79,400	97,600	116,400	135,400	154,200
~180		25,600	51,100	74,800	97,600	121,200	144,900	168,500	191,100
~200		25,600	51,100	74,800	97,600	121,200	144,900	168,500	191,100
~220		30,200	60,600	88,900	116,400	144,900	173,200	200,600	228,900
~240		30,200	60,600	88,900	116,400	144,900	173,200	200,600	228,900
~260		30,200	60,600	88,900	116,400	144,900	173,200	200,600	228,900

※片開きはW300cmまで

		コード式				ドラム式								
H	W	30~45	~90	~140	~190	~240	30~45	~90	~140	~190	~240	~290	~340	~390
50~100		18,600	22,600	35,500	39,300	44,000	21,600	25,600	38,500	42,300	47,000	62,800	67,600	72,400
~140		22,400	26,300	42,300	46,000	50,900	25,400	29,300	45,300	49,000	53,900	72,900	77,800	82,700
~180		23,200	27,200	43,400	47,200	52,300	26,200	30,200	46,400	50,200	55,300	74,400	79,400	84,400
~220		26,900	31,000	50,100	53,900	59,300	29,900	34,000	53,100	56,900	62,300	84,500	89,600	94,700
~260		30,600	34,700	56,900	60,600	66,100	33,600	37,700	59,900	63,600	69,100	94,300	99,800	104,800
~300		34,300	38,400	63,600	67,300	73,100	37,300	41,400	66,600	70,300	76,100	103,900	109,200	114,600

※ドラム式: 仕上り巾39cm以下の場合、仕上り丈は200cmまでとなります。

		コード式	
H	W	18~30	
50~100		18~30	22,800
~140		18~30	26,900
~180		18~30	27,900
~220		18~30	32,000
~240		18~30	35,600

		コード式				ドラム式								
H	W	30~45	~90	~140	~190	~240	30~45	~90	~140	~190	~240	~290	~340	~390
50~100		21,500	27,800	43,200	49,800	56,100	24,500	30,800	46,200	52,800	59,100	76,100	82,700	89,200
~140		25,500	32,200	51,000	58,000	65,000	28,500	35,200	54,000	61,000	68,000	88,200	95,200	102,000
~180		26,500	33,600	52,900	60,500	68,000	29,500	36,600	55,900	63,500	71,000	91,600	99,100	106,400
~220		30,500	38,000	60,700	68,700	76,800	33,500	41,000	63,700	71,700	79,800	103,700	111,400	119,000
~260		34,600	42,700	68,900	77,500	86,400	37,600	45,700	71,900	80,500	89,400	116,700	124,800	133,000
~300		38,700	47,400	77,100	86,300	95,900	41,700	50,400	80,100	89,300	98,900	129,100	137,700	146,300

※ドラム式: 仕上り巾39cm以下の場合、仕上り丈は200cmまでとなります。

		38mm (片開き/タッセルなし)					
H	W	~72	~100	~127	~155	~183	
~100		18,000	29,700	33,900	36,000	47,700	
~140		21,200	36,100	40,300	42,400	57,300	
~180		24,400	42,500	46,700	48,800	66,800	
~220		27,600	48,900	53,100	55,200	76,400	
~260		27,600	48,900	53,100	55,200	76,400	
~300		30,800	55,300	59,500	61,600	85,300	
26mm		-2,800	-2,100	-4,900	-4,200	-4,900	
18mm		-4,900	-5,600	-9,100	-9,800	-10,500	

※生地を伸ばした状態のサイズでご発注ください。

		スプリング・チェーンタイプ				
H	W	30~60	~80	~100	~120	~138
50-80		33,600	36,100	38,100	39,300	41,000
~120		37,300	40,400	42,400	43,500	45,400
~160		38,400	42,200	44,200	45,400	46,700
~200		43,200	46,200	48,400	49,600	50,900
~240			50,400	52,700	53,900	55,300

※丈は巾の3倍までが限度です。
※ロールソフト加工品は非防災品になります。

		ストレートバランス				
H	W	~100	~150	~200	~250	~300
~40		14,000	23,600	28,000	32,400	42,000

※マジックテープ仕様・裏面スポンジ付の価格になります。

H	W	~100	~150	~200	~250	~300
~40		14,500	21,200	27,900	35,600	37,100

※マジックテープ仕様の価格になります。

遮光

TM-54191・54192



巾 ◇ 100cm 価格 ◇ 6,100円/m
組成 ◇ ポリエステル100%

リポート ◇ タテ 60.0cm ヨコ 25.0cm
寸法変化率 ◇ 水洗い/タテ 0.0% ヨコ 0.0%
ドライ/タテ 0.0% ヨコ 0.0%

取扱い表示 ◇ リ-30 30 30 30 30 30 30 30
防炎性能 ◇ (イ) あて布使用
Made in Japan

H	W	~44 1巾(片開き)	~100 2巾	~150 3巾	~200 4巾	~250 5巾	~300 6巾	~350 7巾	~400 8巾
~100		15,400	30,700	44,200	57,700	71,200	84,700	98,200	111,700
~120		15,400	30,700	44,200	57,700	71,200	84,700	98,200	111,700
~140		15,400	30,700	44,200	57,700	71,200	84,700	98,200	111,700
~160		19,900	39,700	57,700	75,700	93,700	111,700	129,700	147,700
~180		19,900	39,700	57,700	75,700	93,700	111,700	129,700	147,700
~200		19,900	39,700	57,700	75,700	93,700	111,700	129,700	147,700
~220		24,400	48,700	71,200	93,700	116,200	138,700	161,200	183,700
~240		24,400	48,700	71,200	93,700	116,200	138,700	161,200	183,700
~260		24,400	48,700	71,200	93,700	116,200	138,700	161,200	183,700
~280		28,900	57,700	84,700	111,700	138,700	165,700	192,700	219,700
約1.5倍ヒダ		~56	~120	~200	~266	~333	~400	~466	~533

※片開きはW270cmまで

H	W	~44 1巾(片開き)	~100 2巾	~150 3巾	~200 4巾	~250 5巾	~300 6巾	~350 7巾	~400 8巾
~100		15,700	31,400	45,300	59,100	73,000	86,800	100,700	114,600
~120		15,700	31,400	45,300	59,100	73,000	86,800	100,700	114,600
~140		15,700	31,400	45,300	59,100	73,000	86,800	100,700	114,600
~160		20,300	40,600	59,100	77,600	96,100	114,600	133,000	151,500
~180		20,300	40,600	59,100	77,600	96,100	114,600	133,000	151,500
~200		20,300	40,600	59,100	77,600	96,100	114,600	133,000	151,500
~220		25,000	49,900	73,000	96,100	119,200	142,300	165,400	188,500
~240		25,000	49,900	73,000	96,100	119,200	142,300	165,400	188,500
~260		25,000	49,900	73,000	96,100	119,200	142,300	165,400	188,500
~280		29,600	59,100	86,800	114,600	142,300	170,000	197,700	225,400
約1.5倍ヒダ		~56	~120	~200	~266	~333	~400	~466	~533

※片開きはW270cmまで

H	W	~44 1巾(片開き)	~100 2巾	~150 3巾	~200 4巾	~250 5巾	~300 6巾	~350 7巾	~400 8巾
~100		15,000	30,000	43,100	56,200	69,400	82,500	95,700	108,800
~120		15,000	30,000	43,100	56,200	69,400	82,500	95,700	108,800
~140		15,000	30,000	43,100	56,200	69,400	82,500	95,700	108,800
~160		19,400	38,700	56,200	73,800	91,300	108,800	126,300	143,800
~180		19,400	38,700	56,200	73,800	91,300	108,800	126,300	143,800
~200		19,400	38,700	56,200	73,800	91,300	108,800	126,300	143,800
~220		23,800	47,500	69,400	91,300	113,200	135,100	157,000	178,900
~240		23,800	47,500	69,400	91,300	113,200	135,100	157,000	178,900
~260		23,800	47,500	69,400	91,300	113,200	135,100	157,000	178,900
~280		28,100	56,200	82,500	108,800	135,100	161,400	187,600	213,900
約1.5倍ヒダ		~56	~120	~200	~266	~333	~400	~466	~533
フラット前ヒダ		~80	~160	~260	~360	~460	~560		

H	W	~44 1巾(片開き)	~100 2巾	~150 3巾	~200 4巾	~250 5巾	~300 6巾	~350 7巾	~400 8巾
~100		16,400	32,800	47,400	62,000	76,600	91,200	105,700	120,300
~120		16,400	32,800	47,400	62,000	76,600	91,200	105,700	120,300
~140		16,400	32,800	47,400	62,000	76,600	91,200	105,700	120,300
~160		21,300	42,600	62,000	81,400	100,900	120,300	139,800	159,200
~180		21,300	42,600	62,000	81,400	100,900	120,300	139,800	159,200
~200		21,300	42,600	62,000	81,400	100,900	120,300	139,800	159,200
~220		26,200	52,300	76,600	100,900	125,200	149,500	173,800	198,100
~240		26,200	52,300	76,600	100,900	125,200	149,500	173,800	198,100
~260		26,200	52,300	76,600	100,900	125,200	149,500	173,800	198,100

※片開きはW300cmまで

		コード式				ドラム式								
H	W	30~45	~90	~140	~190	~240	30~45	~90	~140	~190	~240	~290	~340	~390
50~100		16,500	20,500	31,300	35,200	46,000	19,500	23,500	34,300	38,200	49,000	56,500	67,600	72,400
~140		20,600	24,600	38,800	42,600	56,800	23,600	27,600	41,800	45,600	59,800	67,700	82,000	86,900
~180		24,600	28,600	46,200	50,000	67,400	27,600	31,600	49,200	53,000	70,400	78,600	96,200	101,200
~220		25,500	29,600	47,400	51,200	68,900	28,500	32,600	50,400	54,200	71,900	80,300	98,000	103,100
~260		29,500	33,700	54,800	58,600	79,500	32,500	36,700	57,800	61,600	82,500	91,200	112,400	117,400
~300		33,600	37,800	62,300	66,000	90,200	36,600	40,800	65,300	69,000	93,200	102,400	126,600	132,000

※ドラム式:仕上り巾39cm以下の場合、仕上り丈は200cmまでとなります。

		コード式
H	W	18~30
50~100		20,900
~140		25,300
~180		29,300
~220		30,800
~240		34,700

		コード式				ドラム式								
H	W	30~45	~90	~140	~190	~240	30~45	~90	~140	~190	~240	~290	~340	~390
50~100		19,300	25,600	38,800	45,400	58,400	22,300	28,600	41,800	48,400	61,400	69,500	82,700	89,300
~140		23,700	30,400	47,300	54,400	71,200	26,700	33,400	50,300	57,400	74,200	82,800	99,600	106,400
~180		28,000	35,100	55,800	63,400	84,100	31,000	38,100	58,800	66,400	87,100	96,000	116,700	124,000
~220		29,000	36,600	57,800	65,800	87,100	32,000	39,600	60,800	68,800	90,100	99,400	120,200	127,900
~260		33,500	41,600	66,700	75,400	100,700	36,500	44,600	69,700	78,400	103,700	113,400	138,100	146,200
~300		38,000	46,700	75,700	84,900	114,200	41,000	49,700	78,700	87,900	117,200	127,500	155,900	164,600

※ドラム式:仕上り巾39cm以下の場合、仕上り丈は200cmまでとなります。

		38mm (片開き/タッセルなし)					
H	W	~72	~100	~127	~155	~183	
~100		28,900	31,000	45,400	47,500	59,800	
~140		28,900	31,000	45,400	47,500	59,800	
~180		35,700	37,800	55,600	57,700	73,500	
~220		42,500	44,600	65,900	68,000	87,100	
~260		42,500	44,600	65,900	68,000	87,100	
~300		49,300	51,400	76,100	78,200	100,700	
26mm		-2,800	-2,100	-4,900	-4,200	-4,900	
18mm		-4,900	-5,600	-9,100	-9,800	-10,500	

※生地を伸ばした状態のサイズでご発注ください。

		スプリング・チェーンタイプ		
H	W	30~60	~80	~90
50~80		31,700	34,200	36,200
~120		35,700	38,800	40,800
~160		39,800	43,600	45,600
~200		42,000	45,000	47,200
~240			49,500	51,800

※丈は巾の3倍までが限度です。
※ロールソフト加工品は非防災品になります。

		ストレートバランス				
H	W	~100	~150	~200	~250	~300
~40		14,700	19,100	26,400	30,800	38,200

※マジックテープ仕様・裏面スポンジ付の価格になります。

H	W	~100	~150	~200	~250	~300
~40		21,700	29,100	36,400	50,600	58,000

※マジックテープ仕様の価格になります。

TM-54193・54194

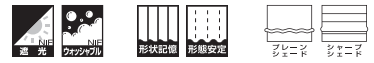

巾 ◇ 150cm 価格 ◇ 7,000円/m リポート ◇ タテ47.5cm ヨコ29.8cm 取扱表示 ◇ リ-30 40 40 40 40 40 40 40
 組成 ◇ ポリエステル100% 寸法変化率 ◇ 水洗い/タテ 0.0% ヨコ 0.0% 防炎性能 ◇ -
 ドライ/タテ 0.0% ヨコ 0.0% Made in Japan

標準仕様 形態安定加工価格表 約2倍ヒダ (タッセル含む)

H	W	~67 1巾(片開き)	~150 2巾	~225 3巾	~300 4巾	~375 5巾	~450 6巾	~525 7巾
~100		15,800	30,500	43,200	56,000	69,600	82,300	95,000
~120		19,400	38,600	56,000	73,200	90,600	107,800	125,100
~140		19,400	38,600	56,000	73,200	90,600	107,800	125,100
~160		23,900	47,700	69,600	90,600	112,400	134,200	156,100
~180		23,900	47,700	69,600	90,600	112,400	134,200	156,100
~200		23,900	47,700	69,600	90,600	112,400	134,200	156,100
~220		28,500	56,000	82,300	107,800	134,200	159,700	186,000
~240		28,500	56,000	82,300	107,800	134,200	159,700	186,000
~260		33,000	65,100	95,000	125,100	156,100	186,000	216,100
~280		33,000	65,100	95,000	125,100	156,100	186,000	216,100
約1.5倍ヒダ		~88	~200	~300	~400	~500		

※片開きはW270cmまで

プライム縫製仕様価格表 約2倍ヒダ (タッセル含む)

H	W	~67 1巾(片開き)	~150 2巾	~225 3巾	~300 4巾	~375 5巾	~450 6巾	~525 7巾
~100		16,200	31,400	44,500	57,700	71,700	84,900	98,000
~120		20,000	39,800	57,700	75,500	93,400	111,200	129,100
~140		20,000	39,800	57,700	75,500	93,400	111,200	129,100
~160		24,600	49,200	71,700	93,400	116,000	138,500	161,100
~180		24,600	49,200	71,700	93,400	116,000	138,500	161,100
~200		24,600	49,200	71,700	93,400	116,000	138,500	161,100
~220		29,400	57,700	84,900	111,200	138,500	164,900	192,000
~240		29,400	57,700	84,900	111,200	138,500	164,900	192,000
~260		34,000	67,100	98,000	129,100	161,100	192,000	223,100
~280		34,000	67,100	98,000	129,100	161,100	192,000	223,100
約1.5倍ヒダ		~88	~200	~300	~400	~500		

※片開きはW270cmまで

レギュラー縫製仕様価格表 約2倍ヒダ (タッセル含む)

H	W	~67 1巾(片開き)	~150 2巾	~225 3巾	~300 4巾	~375 5巾	~450 6巾	~525 7巾	~600 8巾
~100		15,300	29,600	41,900	54,300	67,400	79,700	92,000	104,400
~120		18,800	37,500	54,300	70,900	87,700	104,400	121,100	137,800
~140		18,800	37,500	54,300	70,900	87,700	104,400	121,100	137,800
~160		23,200	46,300	67,400	87,700	108,800	129,900	151,100	171,200
~180		23,200	46,300	67,400	87,700	108,800	129,900	151,100	171,200
~200		23,200	46,300	67,400	87,700	108,800	129,900	151,100	171,200
~220		27,600	54,300	79,700	104,400	129,900	154,600	180,000	204,700
~240		27,600	54,300	79,700	104,400	129,900	154,600	180,000	204,700
~260		32,000	63,100	92,000	121,100	151,100	180,000	209,100	238,100
~280		32,000	63,100	92,000	121,100	151,100	180,000	209,100	238,100
約1.5倍ヒダ		~88	~200	~300	~400	~500	~600	~700	~800
フラット前1倍ヒダ		~130	~260	~410	~560				

形状記憶加工価格表 約2倍ヒダ (タッセル含む)

H	W	~67 1巾(片開き)	~150 2巾	~225 3巾	~300 4巾	~375 5巾	~450 6巾	~525 7巾	~600 8巾
~100		17,100	33,100	47,100	61,100	76,000	90,000	104,000	118,000
~120		21,100	42,000	61,100	80,000	99,100	118,000	137,100	156,000
~140		21,100	42,000	61,100	80,000	99,100	118,000	137,100	156,000
~160		26,000	52,000	76,000	99,100	123,100	147,100	171,100	194,000
~180		26,000	52,000	76,000	99,100	123,100	147,100	171,100	194,000
~200		26,000	52,000	76,000	99,100	123,100	147,100	171,100	194,000
~220		31,100	61,100	90,000	118,000	147,100	175,100	204,000	232,000
~240		31,100	61,100	90,000	118,000	147,100	175,100	204,000	232,000
~260		36,000	71,100	104,000	137,100	171,100	204,000	237,100	270,000

※片開きはW300cmまで

style no.60 プレーンシェード

H	W	コード式				ドラム式								
		30~45	~90	~140	~190	30~45	~90	~140	~190	~240	~290	~340	~390	
50~100		19,300	23,200	27,800	40,000	44,600	22,300	26,200	30,800	43,000	47,600	55,100	68,300	73,100
~140		22,600	26,600	31,300	46,500	51,400	25,600	29,600	34,300	49,500	54,400	62,200	78,600	83,500
~180		26,500	30,500	35,500	53,600	58,700	29,500	33,500	38,500	56,600	61,700	69,700	89,200	94,200
~220		27,400	31,400	36,600	54,800	60,200	30,400	34,400	39,600	57,800	63,200	71,400	91,000	96,100
~260		31,300	35,400	40,800	61,400	66,900	34,300	38,400	43,800	64,400	69,900	78,300	101,300	106,300
~300		35,200	39,300	45,000	68,500	74,300	38,200	42,300	48,000	71,500	77,300	86,100	111,300	116,600

※ドラム式: 仕上り巾39cm以下の場合、仕上り丈は200cmまでとなります。

スリムシェード

H	W	コード式
		18~30
50~100		23,400
~140		27,200
~180		31,000
~220		32,500
~240		36,300

style no.63 シャープシェード

H	W	コード式				ドラム式								
		30~45	~90	~140	~190	30~45	~90	~140	~190	~240	~290	~340	~390	
50~100		22,200	28,500	35,100	50,500	56,900	25,200	31,500	38,100	53,500	59,900	68,000	83,400	90,000
~140		25,800	32,400	39,500	58,600	65,500	28,800	35,400	42,500	61,600	68,500	77,100	96,000	102,800
~180		29,900	37,100	44,600	67,300	74,800	32,900	40,100	47,600	70,300	77,800	86,700	109,400	116,700
~220		31,000	38,500	46,600	69,700	77,800	34,000	41,500	49,600	72,700	80,800	90,100	112,900	120,500
~260		35,300	43,400	52,100	78,300	87,200	38,300	46,400	55,100	81,300	90,200	99,900	126,400	134,500
~300		39,600	48,300	57,600	87,600	97,200	42,600	51,300	60,600	90,600	100,200	110,400	139,900	148,500

※ドラム式: 仕上り巾39cm以下の場合、仕上り丈は200cmまでとなります。

ハトメカーテン 約1.8倍ヒダ

H	W	38mm (片開き/タッセルなし)					
		~72	~100	~127	~155	~183	~211
~100		18,700	30,300	34,500	36,600	48,200	
~140		21,400	36,400	40,600	42,700	57,700	
~180		24,800	43,200	47,400	49,500	67,900	
~220		28,200	49,300	53,500	55,600	77,400	
~260		31,600	56,100	60,300	62,400	86,900	
~300		34,300	62,200	66,400	68,500	96,500	
26mm		-2,800	-2,100	-4,900	-4,200	-4,900	
18mm		-4,900	-5,600	-9,100	-9,800	-10,500	

※生地を伸ばした状態のサイズでご発注ください。

バランス

ストレートバランス						
H	W	~100	~150	~200	~250	~300
~40		14,400	23,900	28,300	32,700	42,700

※マジックテープ仕様・裏面スポンジ付の価格となります。

三つ山・箱ヒダバランス (約2.5倍ヒダ)

H	W	~100	~150	~200	~250	~300
~40		14,800	21,900	28,400	36,500	38,000

※マジックテープ仕様の価格となります。

TM-54195~54197



巾 ◇ 150cm 価格 ◇ 7,500円/m リピート ◇ タテ 38.4cm ヨコ 30.0cm 取扱い表示 ◇ リ-30 30 40 50 60 70 80 90 100
 組成 ◇ ポリエステル100% 寸法変化率 ◇ 水洗い/タテ 0.0% ヨコ 0.0% 防炎性能 ◇ (イ) あて布使用
 ドライ/タテ 0.0% ヨコ 0.0% Made in Japan

H	W	~67 1巾(片開き)	~150 2巾	~225 3巾	~300 4巾	~375 5巾	~450 6巾	~525 7巾
~100		17,500	34,100	48,400	63,800	78,200	93,600	107,900
~120		21,300	41,800	59,900	78,200	96,400	115,600	133,900
~140		21,300	41,800	59,900	78,200	96,400	115,600	133,900
~160		24,300	48,400	71,400	93,600	115,600	137,800	159,800
~180		24,300	48,400	71,400	93,600	115,600	137,800	159,800
~200		28,100	56,100	82,100	107,900	133,900	159,800	185,800
~220		28,100	56,100	82,100	107,900	133,900	159,800	185,800
~240		32,000	63,800	93,600	122,400	152,100	181,900	210,700
~260		32,000	63,800	93,600	122,400	152,100	181,900	210,700
~280		35,800	71,400	104,100	137,800	170,400	203,900	236,600
約1.5倍ヒダ		~88	~200	~300	~400	~500		

※片開きはW270cmまで

H	W	~67 1巾(片開き)	~150 2巾	~225 3巾	~300 4巾	~375 5巾	~450 6巾	~525 7巾
~100		18,000	35,000	49,800	65,600	80,600	96,400	111,200
~120		21,900	42,900	61,700	80,600	99,300	119,100	138,000
~140		21,900	42,900	61,700	80,600	99,300	119,100	138,000
~160		25,000	49,800	73,500	96,400	119,100	141,900	164,600
~180		25,000	49,800	73,500	96,400	119,100	141,900	164,600
~200		29,000	57,700	84,500	111,200	138,000	164,600	191,400
~220		29,000	57,700	84,500	111,200	138,000	164,600	191,400
~240		32,900	65,600	96,400	126,100	156,700	187,500	217,200
~260		32,900	65,600	96,400	126,100	156,700	187,500	217,200
~280		36,900	73,500	107,200	141,900	175,600	210,200	243,800
約1.5倍ヒダ		~88	~200	~300	~400	~500		

※片開きはW270cmまで

H	W	~67 1巾(片開き)	~150 2巾	~225 3巾	~300 4巾	~375 5巾	~450 6巾	~525 7巾	~600 8巾
~100		17,000	33,100	47,000	61,900	75,900	90,800	104,700	118,700
~120		20,700	40,600	58,200	75,900	93,500	112,100	129,900	147,500
~140		20,700	40,600	58,200	75,900	93,500	112,100	129,900	147,500
~160		23,600	47,000	69,300	90,800	112,100	133,600	154,900	176,400
~180		23,600	47,000	69,300	90,800	112,100	133,600	154,900	176,400
~200		27,300	54,500	79,600	104,700	129,900	154,900	180,100	204,300
~220		27,300	54,500	79,600	104,700	129,900	154,900	180,100	204,300
~240		31,000	61,900	90,800	118,700	147,500	176,400	204,300	233,000
~260		31,000	61,900	90,800	118,700	147,500	176,400	204,300	233,000
~280		34,800	69,300	101,000	133,600	165,200	197,700	229,300	261,900
約1.5倍ヒダ		~88	~200	~300	~400	~500	~600	~700	~800
フラット前ヒダ		~130	~260	~410	~560				

H	W	~67 1巾(片開き)	~150 2巾	~225 3巾	~300 4巾	~375 5巾	~450 6巾	~525 7巾	~600 8巾
~100		18,900	36,900	52,500	69,300	85,200	102,000	117,600	133,500
~120		23,100	45,300	65,100	85,200	105,000	126,000	146,100	165,900
~140		23,100	45,300	65,100	85,200	105,000	126,000	146,100	165,900
~160		26,400	52,500	77,700	102,000	126,000	150,300	174,300	198,600
~180		26,400	52,500	77,700	102,000	126,000	150,300	174,300	198,600
~200		30,600	60,900	89,400	117,600	146,100	174,300	202,800	230,100
~220		30,600	60,900	89,400	117,600	146,100	174,300	202,800	230,100
~240		34,800	69,300	102,000	133,500	165,900	198,600	230,100	262,500
~260		34,800	69,300	102,000	133,500	165,900	198,600	230,100	262,500

※片開きはW300cmまで

H	W	コード式				ドラム式								
		30~45	~90	~140	~240	30~45	~90	~140	~190	~240	~290	~340	~390	
50~100		20,600	24,500	29,100	42,400	47,100	23,600	27,500	32,100	45,400	50,100	57,600	72,100	76,900
~140		24,100	28,000	32,800	48,700	53,700	27,100	31,000	35,800	51,700	56,700	64,500	81,700	86,600
~180		26,900	30,900	35,900	54,400	59,500	29,900	33,900	38,900	57,400	62,500	70,500	91,000	96,000
~220		30,400	34,400	39,600	60,600	66,000	33,400	37,400	42,600	63,600	69,000	77,400	99,900	105,000
~260		33,900	37,900	43,300	66,900	72,400	36,900	40,900	46,300	69,900	75,400	84,000	109,500	114,500
~300		37,400	41,500	47,100	73,200	79,000	40,400	44,500	50,100	76,200	82,000	90,900	118,200	123,500

※ドラム式：仕上り巾39cm以下の場合、仕上り丈は200cmまでとなります。

H	W	コード式
50~100		18~30
~140		24,600
~180		28,500
~220		31,300
~240		35,200
~260		36,200

H	W	スプリング・チェーンタイプ				
		30~60	~80	~100	~120	
50~80		35,400	37,900	39,900	41,100	42,800
~120		38,900	42,000	44,000	45,100	47,000
~160		41,800	45,600	47,600	48,800	50,100
~200		46,400	49,400	51,600	52,800	54,100
~240		53,400	55,700	56,900	58,300	

※丈は巾の3倍までが限度です。
 ※ロールソフト加工品は非防炎品になります。

H	W	~72	~100	~127	~155	~183
38mm						
~100		20,000	32,900	37,100	39,200	52,100
~140		22,800	38,700	42,900	45,000	60,700
~180		25,000	43,700	47,900	50,000	69,300
~220		27,900	49,400	53,600	55,700	77,300
~260		30,800	55,200	59,400	61,500	85,900
~300		33,700	60,900	65,100	67,200	93,800
26mm		-2,800	-2,100	-4,900	-4,200	-4,900
18mm		-4,900	-5,600	-9,100	-9,800	-10,500

※生地を伸ばした状態のサイズでご発注ください。

H	W	~100	~150	~200	~250	~300
ストレートバランス						
~40		13,600	22,800	27,200	31,600	40,200

※マジックテープ仕様・裏面スポンジ付の価格になります。

H	W	~100	~150	~200	~250	~300
~40		13,700	19,400	25,700	33,000	34,500

※マジックテープ仕様の価格になります。

遮光

TM-54198・54199

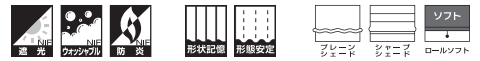

巾 ◇ 100cm 価格 ◇ 6,300円/m リポート ◇ タテ43.0cm ヨコ50.0cm 取扱い表示 ◇ リ-30 40℃ 防炎性能 ◇ (イ) 炎付使用
 組成 ◇ ポリエステル100% 寸法変化率 ◇ 水洗い/タテ 0.0% ヨコ -0.5% ドライ/タテ 0.3% ヨコ 0.3% Made in Japan

H	W	~44 1巾(片開き)	~100 2巾	~150 3巾	~200 4巾	~250 5巾	~300 6巾	~350 7巾	~400 8巾
~100		15,800	30,700	43,800	56,900	70,000	83,800	96,900	110,000
~120		15,800	30,700	43,800	56,900	70,000	83,800	96,900	110,000
~140		18,800	36,900	53,800	70,000	86,900	103,100	120,000	136,200
~160		18,800	36,900	53,800	70,000	86,900	103,100	120,000	136,200
~180		21,900	43,800	63,800	83,800	103,100	123,100	143,100	163,200
~200		21,900	43,800	63,800	83,800	103,100	123,100	143,100	163,200
~220		21,900	43,800	63,800	83,800	103,100	123,100	143,100	163,200
~240		25,800	50,700	73,800	96,900	120,000	143,100	166,200	189,300
~260		25,800	50,700	73,800	96,900	120,000	143,100	166,200	189,300
~280		28,900	56,900	83,800	110,000	136,200	163,200	189,300	216,300
約1.5倍ヒダ		~56	~120	~200	~266	~333	~400	~466	~533

※片開きはW270cmまで

H	W	~44 1巾(片開き)	~100 2巾	~150 3巾	~200 4巾	~250 5巾	~300 6巾	~350 7巾	~400 8巾
~100		16,100	31,400	44,800	58,300	71,700	85,900	99,400	112,800
~120		16,100	31,400	44,800	58,300	71,700	85,900	99,400	112,800
~140		19,300	37,700	55,100	71,700	89,100	105,700	123,100	139,600
~160		19,300	37,700	55,100	71,700	89,100	105,700	123,100	139,600
~180		22,400	44,800	65,400	85,900	105,700	126,200	146,800	167,300
~200		22,400	44,800	65,400	85,900	105,700	126,200	146,800	167,300
~220		22,400	44,800	65,400	85,900	105,700	126,200	146,800	167,300
~240		26,400	52,000	75,700	99,400	123,100	146,800	170,500	194,200
~260		26,400	52,000	75,700	99,400	123,100	146,800	170,500	194,200
~280		29,600	58,300	85,900	112,800	139,600	167,300	194,200	221,800
約1.5倍ヒダ		~56	~120	~200	~266	~333	~400	~466	~533

※片開きはW270cmまで

H	W	~44 1巾(片開き)	~100 2巾	~150 3巾	~200 4巾	~250 5巾	~300 6巾	~350 7巾	~400 8巾
~100		15,400	30,000	42,800	55,500	68,300	81,800	94,500	107,300
~120		15,400	30,000	42,800	55,500	68,300	81,800	94,500	107,300
~140		18,400	36,000	52,500	68,300	84,800	100,500	117,000	132,800
~160		18,400	36,000	52,500	68,300	84,800	100,500	117,000	132,800
~180		21,400	42,800	62,300	81,800	100,500	120,000	139,500	159,000
~200		21,400	42,800	62,300	81,800	100,500	120,000	139,500	159,000
~220		21,400	42,800	62,300	81,800	100,500	120,000	139,500	159,000
~240		25,200	49,500	72,000	94,500	117,000	139,500	162,000	184,500
~260		25,200	49,500	72,000	94,500	117,000	139,500	162,000	184,500
~280		28,200	55,500	81,800	107,300	132,800	159,000	184,500	210,800
約1.5倍ヒダ		~56	~120	~200	~266	~333	~400	~466	~533
フラット前ヒダ		~80	~160	~260	~360	~460	~560		

H	W	~44 1巾(片開き)	~100 2巾	~150 3巾	~200 4巾	~250 5巾	~300 6巾	~350 7巾	~400 8巾
~100		16,800	32,800	46,900	61,000	75,100	90,100	104,200	118,300
~120		16,800	32,800	46,900	61,000	75,100	90,100	104,200	118,300
~140		20,200	39,500	57,700	75,100	93,400	110,800	129,100	146,500
~160		20,200	39,500	57,700	75,100	93,400	110,800	129,100	146,500
~180		23,500	46,900	68,500	90,100	110,800	132,400	154,000	175,600
~200		23,500	46,900	68,500	90,100	110,800	132,400	154,000	175,600
~220		23,500	46,900	68,500	90,100	110,800	132,400	154,000	175,600
~240		27,600	54,400	79,300	104,200	129,100	154,000	178,900	203,800
~260		27,600	54,400	79,300	104,200	129,100	154,000	178,900	203,800

※片開きはW300cmまで

H	W	コード式				ドラム式								
		30~45	~90	~140	~190	30~45	~90	~140	~190	~240	~290	~340	~390	
50~100		17,300	21,200	32,800	36,700	48,200	20,300	24,200	35,800	39,700	51,200	58,800	70,600	75,400
~140		20,900	24,900	38,900	42,700	56,600	23,900	27,900	41,900	45,700	59,600	67,500	81,700	86,500
~180		23,900	27,900	44,300	48,100	64,900	26,900	30,900	47,300	51,100	67,900	76,100	92,500	97,500
~220		27,000	31,100	50,400	54,100	73,200	30,000	34,100	53,400	57,100	76,200	84,800	104,000	109,100
~260		30,600	34,700	56,400	60,100	81,500	33,600	37,700	59,400	63,100	84,500	93,300	115,000	120,000
~300		33,700	37,800	61,900	65,600	89,900	36,700	40,800	64,900	68,600	92,900	102,100	125,900	131,200

※ドラム式: 仕上り巾39cm以下の場合、仕上り丈は200cmまでとなります。

H	W	コード式
50~100		18~30
~140		21,600
~180		25,600
~220		28,600
~260		32,200
~300		33,200

H	W	コード式				ドラム式								
		30~45	~90	~140	~190	30~45	~90	~140	~190	~240	~290	~340	~390	
50~100		20,100	26,400	40,400	47,000	60,700	23,100	29,400	43,400	50,000	63,700	71,900	85,800	92,400
~140		24,000	30,700	47,400	54,500	71,100	27,000	33,700	50,400	57,500	74,100	82,600	99,200	106,000
~180		27,300	34,400	53,900	61,400	81,500	30,300	37,400	56,900	64,400	84,500	93,400	112,800	120,100
~220		30,600	38,200	60,900	68,900	91,800	33,600	41,200	63,900	71,900	94,800	104,100	126,500	134,100
~260		34,600	42,700	68,400	77,000	102,900	37,600	45,700	71,400	80,000	105,900	115,600	140,800	148,900
~300		38,100	46,700	75,300	84,500	113,900	41,100	49,700	78,300	87,500	116,900	127,200	155,100	163,800

※ドラム式: 仕上り巾39cm以下の場合、仕上り丈は200cmまでとなります。

H	W	38mm	片開き/タッセルなし			
~100		~72	~100	~127	~155	~183
~140		28,900	31,000	45,100	47,200	59,200
~180		33,600	35,700	52,700	54,800	69,200
~220		38,800	40,900	60,300	62,400	79,700
~260		38,800	40,900	60,300	62,400	79,700
~300		44,100	46,200	67,900	70,000	89,600
~300		48,700	50,800	75,500	77,600	99,500
26mm		-2,800	-2,100	-4,900	-4,200	-4,900
18mm		-4,900	-5,600	-9,100	-9,800	-10,500

※生地を伸ばした状態のサイズでご発注ください。

H	W	スプリング・チェーンタイプ		
		30~60	~80	~90
50~80		32,400	34,900	36,900
~120		36,000	39,100	41,100
~160		39,100	42,900	44,900
~200		43,400	46,400	48,600
~240			50,500	52,800

※丈は巾の3倍までが限度です。
※ロールソフト加工品は非防炎品になります。

ストレートバランス						
H	W	~100	~150	~200	~250	~300
~40		17,900	22,300	30,800	35,200	44,100
※マジックテープ仕様・裏面スポンジ付の価格になります。						
三ツ山・箱ヒダバランス (約2.5倍ヒダ)						
H	W	~100	~150	~200	~250	~300
~40		17,300	23,300	28,800	40,400	45,900
※マジックテープ仕様・裏面スポンジ付の価格になります。						

TM-54200・54201



巾 ◇ 100cm 価格 ◇ 6,000円/m
組成 ◇ ポリエステル100%

リポート ◇ タテ 37.4cm ヨコ 25.0cm
寸法変化率 ◇ 水洗い/タテ -0.2% ヨコ 0.0%
ドライ/タテ 0.0% ヨコ 0.2%

取り扱い表示 ◇ リ-30 30 30 30 30 30 30 30
防炎性能 ◇ (イ) ちて布使用
Made in Japan

H	W	~44 1巾(片開き)	~100 2巾	~150 3巾	~200 4巾	~250 5巾	~300 6巾	~350 7巾	~400 8巾
~100		12,900	25,800	36,900	48,000	59,100	70,200	81,300	92,400
~120		15,900	31,800	45,800	59,100	73,200	87,300	100,600	114,600
~140		15,900	31,800	45,800	59,100	73,200	87,300	100,600	114,600
~160		18,900	36,900	54,000	70,200	87,300	103,500	119,800	136,800
~180		18,900	36,900	54,000	70,200	87,300	103,500	119,800	136,800
~200		21,800	42,900	62,100	81,300	100,600	119,800	139,800	159,000
~220		21,800	42,900	62,100	81,300	100,600	119,800	139,800	159,000
~240		24,000	48,000	70,200	92,400	114,600	136,800	159,000	181,200
~260		24,000	48,000	70,200	92,400	114,600	136,800	159,000	181,200
~280		27,000	54,000	78,400	103,500	128,700	153,100	178,300	203,400
約1.5倍ヒダ		~56	~120	~200	~266	~333	~400	~466	~533

※片開きはW270cmまで

H	W	~44 1巾(片開き)	~100 2巾	~150 3巾	~200 4巾	~250 5巾	~300 6巾	~350 7巾	~400 8巾
~100		13,200	26,400	37,800	49,200	60,600	72,000	83,400	94,800
~120		16,300	32,500	47,000	60,600	75,100	89,500	103,200	117,600
~140		16,300	32,500	47,000	60,600	75,100	89,500	103,200	117,600
~160		19,300	37,800	55,300	72,000	89,500	106,200	123,000	140,400
~180		19,300	37,800	55,300	72,000	89,500	106,200	123,000	140,400
~200		22,400	43,900	63,700	83,400	103,200	123,000	143,500	163,200
~220		22,400	43,900	63,700	83,400	103,200	123,000	143,500	163,200
~240		24,600	49,200	72,000	94,800	117,600	140,400	163,200	186,000
~260		24,600	49,200	72,000	94,800	117,600	140,400	163,200	186,000
~280		27,700	55,300	80,400	106,200	132,100	157,200	183,000	208,800
約1.5倍ヒダ		~56	~120	~200	~266	~333	~400	~466	~533

※片開きはW270cmまで

H	W	~44 1巾(片開き)	~100 2巾	~150 3巾	~200 4巾	~250 5巾	~300 6巾	~350 7巾	~400 8巾
~100		12,600	25,200	36,000	46,800	57,600	68,400	79,200	90,000
~120		15,500	31,000	44,700	57,600	71,300	85,000	98,000	111,600
~140		15,500	31,000	44,700	57,600	71,300	85,000	98,000	111,600
~160		18,400	36,000	52,600	68,400	85,000	100,800	116,700	133,200
~180		18,400	36,000	52,600	68,400	85,000	100,800	116,700	133,200
~200		21,300	41,800	60,500	79,200	98,000	116,700	136,100	154,800
~220		21,300	41,800	60,500	79,200	98,000	116,700	136,100	154,800
~240		23,400	46,800	68,400	90,000	111,600	133,200	154,800	176,400
~260		23,400	46,800	68,400	90,000	111,600	133,200	154,800	176,400
~280		26,300	52,600	76,400	100,800	125,300	149,100	173,600	198,000
約1.5倍ヒダ		~56	~120	~200	~266	~333	~400	~466	~533
フラット前ヒダ		~80	~160	~260	~360	~460	~560		

H	W	~44 1巾(片開き)	~100 2巾	~150 3巾	~200 4巾	~250 5巾	~300 6巾	~350 7巾	~400 8巾
~100		13,800	27,600	39,600	51,600	63,600	75,600	87,600	99,600
~120		17,000	34,000	49,200	63,600	78,800	94,000	108,400	123,600
~140		17,000	34,000	49,200	63,600	78,800	94,000	108,400	123,600
~160		20,200	39,600	58,000	75,600	94,000	111,600	129,200	147,600
~180		20,200	39,600	58,000	75,600	94,000	111,600	129,200	147,600
~200		23,400	46,000	66,800	87,600	108,400	129,200	150,800	171,600
~220		23,400	46,000	66,800	87,600	108,400	129,200	150,800	171,600
~240		25,800	51,600	75,600	99,600	123,600	147,600	171,600	195,600
~260		25,800	51,600	75,600	99,600	123,600	147,600	171,600	195,600

※片開きはW300cmまで

		コード式				ドラム式								
H	W	30~45	~90	~140	~190	~240	30~45	~90	~140	~190	~240	~290	~340	~390
50~100		18,000	21,900	34,200	38,000	50,300	21,000	24,900	37,200	41,000	53,300	60,900	73,400	78,200
~140		21,000	24,900	39,500	43,300	57,800	24,000	27,900	42,500	46,300	60,800	68,800	83,000	87,900
~180		23,900	27,900	44,300	48,100	64,800	26,900	30,900	47,300	51,100	67,800	75,900	92,300	97,300
~220		26,900	30,900	49,500	53,300	71,800	29,900	33,900	52,500	56,300	74,800	83,300	101,800	107,000
~260		29,300	33,400	54,300	58,100	78,700	32,300	36,400	57,300	61,100	81,700	90,500	111,400	116,400
~300		32,200	36,400	59,600	63,400	85,800	35,200	39,400	62,600	66,400	88,800	97,900	120,700	126,100

※ドラム式: 仕上り巾39cm以下の場合、仕上り丈は200cmまでとなります。

		コード式	
H	W	18~30	
50~100		18~30	22,200
~140			25,700
~180			28,600
~220			32,000
~240			33,000

		コード式				ドラム式								
H	W	30~45	~90	~140	~190	~240	30~45	~90	~140	~190	~240	~290	~340	~390
50~100		20,800	27,100	41,800	48,400	62,900	23,800	30,100	44,800	51,400	65,900	74,100	88,700	95,300
~140		24,000	30,700	48,100	55,100	72,400	27,000	33,700	51,100	58,100	75,400	83,900	100,600	107,400
~180		27,200	34,400	53,800	61,400	81,300	30,200	37,400	56,800	64,400	84,300	93,200	112,600	119,900
~220		30,400	38,000	60,100	68,100	90,300	33,400	41,000	63,100	71,100	93,300	102,500	124,200	131,900
~260		33,200	41,400	66,200	74,800	99,900	36,200	44,400	69,200	77,800	102,900	112,600	137,000	145,100
~300		36,600	45,300	72,900	82,100	109,500	39,600	48,300	75,900	85,100	112,500	122,800	149,800	158,400

※ドラム式: 仕上り巾39cm以下の場合、仕上り丈は200cmまでとなります。

		38mm (片開き/タッセルなし)					
H	W	~72	~100	~127	~155	~183	
~100		25,200	27,300	39,900	42,000	52,500	
~140		29,700	31,800	46,700	48,800	60,900	
~180		33,600	35,700	52,800	54,900	69,300	
~220		38,100	40,200	59,000	61,100	77,700	
~260		42,000	44,100	65,100	67,200	86,100	
~300		46,500	48,600	71,300	73,400	94,500	
26mm		-2,800	-2,100	-4,900	-4,200	-4,900	
18mm		-4,900	-5,600	-9,100	-9,800	-10,500	

※生地を伸ばした状態のサイズでご発注ください。

		スプリング・チェーンタイプ	
H	W	30~60	~80
50~80		33,000	35,500
~120		36,100	39,200
~160		39,100	42,900
~200		43,200	48,400
~240			49,200

※丈は巾の3倍までが限度です。
※ロールソフト加工品は非防炎品になります。

		ストレートバランス			
H	W	~100	~150	~200	~250
~40		16,000	20,400	28,700	33,100

※マジックテープ仕様・裏面スポンジ付の価格になります。

H	W	~100	~150	~200	~250
~40		15,200	20,000	25,400	35,100

※マジックテープ仕様の価格になります。

遮光

TM-54202・54203

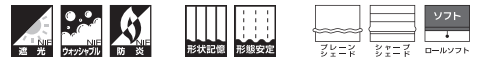

巾 ◇ 100cm 価格 ◇ 7,000円/m リポート ◇ タテ54.0cm ヨコ50.0cm 取扱表示 ◇ リ-30 40 炎 1 2 3 4 5 6 7 8 9 10 11 12 13 14 15 16 17 18 19 20 21 22 23 24 25 26 27 28 29 30 31 32 33 34 35 36 37 38 39 40 41 42 43 44 45 46 47 48 49 50 51 52 53 54 55 56 57 58 59 60 61 62 63 64 65 66 67 68 69 70 71 72 73 74 75 76 77 78 79 80 81 82 83 84 85 86 87 88 89 90 91 92 93 94 95 96 97 98 99 100
 組成 ◇ ポリエステル100% 寸法変化率 ◇ 水洗い/タテ 0.0% ヨコ -0.2% 防炎性能 ◇ (イ) 乾燥/タテ 0.0% ヨコ 0.0% Made in Japan

H	W	~44 1巾(片開き)	~100 2巾	~150 3巾	~200 4巾	~250 5巾	~300 6巾	~350 7巾	~400 8巾
~100		16,300	31,800	45,200	58,600	72,100	86,400	99,800	113,200
~120		16,300	31,800	45,200	58,600	72,100	86,400	99,800	113,200
~140		20,500	41,000	58,600	77,100	94,800	113,200	131,700	149,400
~160		20,500	41,000	58,600	77,100	94,800	113,200	131,700	149,400
~180		20,500	41,000	58,600	77,100	94,800	113,200	131,700	149,400
~200		24,700	49,400	72,100	94,800	117,400	140,100	162,800	185,500
~220		24,700	49,400	72,100	94,800	117,400	140,100	162,800	185,500
~240		29,800	58,600	86,400	113,200	140,100	167,800	194,700	222,400
~260		29,800	58,600	86,400	113,200	140,100	167,800	194,700	222,400
~280		29,800	58,600	86,400	113,200	140,100	167,800	194,700	222,400
約1.5倍ヒダ		~56	~120	~200	~266	~333	~400	~466	~533

※片開きはW270cmまで

H	W	~44 1巾(片開き)	~100 2巾	~150 3巾	~200 4巾	~250 5巾	~300 6巾	~350 7巾	~400 8巾
~100		16,700	32,400	46,200	59,900	73,700	88,300	102,100	115,800
~120		16,700	32,400	46,200	59,900	73,700	88,300	102,100	115,800
~140		21,000	41,900	59,900	78,900	96,900	115,800	134,800	152,800
~160		21,000	41,900	59,900	78,900	96,900	115,800	134,800	152,800
~180		21,000	41,900	59,900	78,900	96,900	115,800	134,800	152,800
~200		25,300	50,500	73,700	96,900	120,100	143,400	166,600	189,800
~220		25,300	50,500	73,700	96,900	120,100	143,400	166,600	189,800
~240		30,400	59,900	88,300	115,800	143,400	171,700	199,300	227,600
~260		30,400	59,900	88,300	115,800	143,400	171,700	199,300	227,600
~280		30,400	59,900	88,300	115,800	143,400	171,700	199,300	227,600
約1.5倍ヒダ		~56	~120	~200	~266	~333	~400	~466	~533

※片開きはW270cmまで

H	W	~44 1巾(片開き)	~100 2巾	~150 3巾	~200 4巾	~250 5巾	~300 6巾	~350 7巾	~400 8巾
~100		16,000	31,100	44,200	57,300	70,500	84,400	97,500	110,600
~120		16,000	31,100	44,200	57,300	70,500	84,400	97,500	110,600
~140		20,100	40,100	57,300	75,400	92,600	110,600	128,700	145,900
~160		20,100	40,100	57,300	75,400	92,600	110,600	128,700	145,900
~180		20,100	40,100	57,300	75,400	92,600	110,600	128,700	145,900
~200		24,200	48,300	70,500	92,600	114,700	136,900	159,000	181,200
~220		24,200	48,300	70,500	92,600	114,700	136,900	159,000	181,200
~240		29,100	57,300	84,400	110,600	136,900	163,900	190,200	217,200
~260		29,100	57,300	84,400	110,600	136,900	163,900	190,200	217,200
~280		29,100	57,300	84,400	110,600	136,900	163,900	190,200	217,200
約1.5倍ヒダ		~56	~120	~200	~266	~333	~400	~466	~533
フラット前ヒダ		~80	~160	~260	~360	~460	~560		

H	W	~44 1巾(片開き)	~100 2巾	~150 3巾	~200 4巾	~250 5巾	~300 6巾	~350 7巾	~400 8巾
~100		17,300	33,700	48,100	62,500	76,900	92,200	106,600	121,000
~120		17,300	33,700	48,100	62,500	76,900	92,200	106,600	121,000
~140		21,800	43,600	62,500	82,300	101,200	121,000	140,800	159,700
~160		21,800	43,600	62,500	82,300	101,200	121,000	140,800	159,700
~180		21,800	43,600	62,500	82,300	101,200	121,000	140,800	159,700
~200		26,300	52,600	76,900	101,200	125,500	149,800	174,100	198,400
~220		26,300	52,600	76,900	101,200	125,500	149,800	174,100	198,400
~240		31,700	62,500	92,200	121,000	149,800	179,500	208,300	238,000
~260		31,700	62,500	92,200	121,000	149,800	179,500	208,300	238,000

※片開きはW300cmまで

		コード式				ドラム式							
H	W	30~45	~90	~140	~190	30~45	~90	~140	~190	~240	~290	~340	~390
50~100		20,500	24,400	38,600	42,300	23,500	27,400	41,600	45,300	59,400	67,100	81,600	86,400
~140		21,400	25,400	39,800	43,500	24,400	28,400	42,800	46,500	60,900	68,900	83,400	88,300
~180		25,300	29,300	47,500	51,300	28,300	32,300	50,500	54,300	71,700	80,000	98,200	103,200
~220		29,300	33,200	54,700	58,400	32,300	36,200	57,700	61,400	82,600	91,300	112,700	117,800
~260		33,700	37,800	62,500	66,100	36,700	40,800	65,500	69,100	94,000	103,000	127,700	132,700
~300		34,600	38,700	63,600	67,300	37,600	41,700	66,600	70,300	95,500	104,700	129,300	134,700

※ドラム式: 仕上り巾39cm以下の場合、仕上り丈は200cmまでとなります。

		コード式
H	W	18~30
50~100		24,600
~140		26,100
~180		29,900
~220		34,200
~240		35,200

		コード式				ドラム式							
H	W	30~45	~90	~140	~190	30~45	~90	~140	~190	~240	~290	~340	~390
50~100		23,400	29,700	46,400	53,000	26,400	32,700	49,400	56,000	72,500	80,600	97,300	103,900
~140		24,500	31,200	48,400	55,400	27,500	34,200	51,400	58,400	75,500	84,000	101,000	107,900
~180		28,700	35,800	57,200	64,800	31,700	38,800	60,200	67,800	88,500	97,500	118,800	126,100
~220		32,900	40,400	65,500	73,500	35,900	43,400	68,500	76,500	101,600	110,900	135,600	143,200
~260		37,800	46,000	74,700	83,400	40,800	49,000	77,700	86,400	116,000	125,800	154,100	162,200
~300		39,000	47,700	77,100	86,300	42,000	50,700	80,100	89,300	119,700	130,000	158,800	167,400

※ドラム式: 仕上り巾39cm以下の場合、仕上り丈は200cmまでとなります。

		(片開き/タッセルなし)					
H	W	~72	~100	~127	~155	~183	
38mm							
50~100		29,600	31,700	46,100	48,200	60,500	
~140		36,600	38,700	56,300	58,400	74,600	
~180		36,600	38,700	56,300	58,400	74,600	
~220		43,000	45,100	66,600	68,700	88,100	
~260		50,000	52,100	77,500	79,600	102,100	
~300		57,100	59,200	87,700	89,800	116,200	
26mm		-2,800	-2,100	-4,900	-4,200	-4,900	
18mm		-4,900	-5,600	-9,100	-9,800	-10,500	

※生地を伸ばした状態のサイズでご発注ください。

		スプリング・チェーンタイプ		
H	W	30~60	~80	~90
50~80		35,400	37,900	39,900
~120		36,500	39,600	41,600
~160		40,400	44,200	46,200
~200		45,400	48,400	50,600
~240			53,300	55,600

※丈は巾の3倍までが限度です。
 ※ロールソフト加工品は非防炎品になります。

		ストレートバランス				
H	W	~100	~150	~200	~250	~300
~40		21,200	25,600	36,100	40,500	51,100

※マジックテープ仕様・裏面スポンジ付の価格になります。

		三ツ山・箱ヒダバランス (約2.5倍ヒダ)				
H	W	~100	~150	~200	~250	~300
~40		22,600	30,300	37,400	52,200	59,900

※マジックテープ仕様の価格になります。

TM-54206~54208

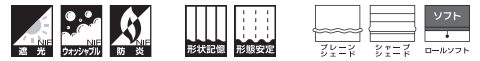

巾 ◇ 145 cm 価格 ◇ 6,400 円/m リポート ◇ タテ 16.2 cm ヨコ 9.6 cm 取扱い表示 ◇ リ-30 40 炎 1 2 3 4 5 6 7 8 9 10 11 12 13 14 15 16 17 18 19 20 21 22 23 24 25 26 27 28 29 30 31 32 33 34 35 36 37 38 39 40 41 42 43 44 45 46 47 48 49 50 51 52 53 54 55 56 57 58 59 60 61 62 63 64 65 66 67 68 69 70 71 72 73 74 75 76 77 78 79 80 81 82 83 84 85 86 87 88 89 90 91 92 93 94 95 96 97 98 99 100
 組成 ◇ ポリエステル100% 寸法変化率 ◇ 水洗い/タテ -0.3% ヨコ -0.3% 防炎性能 ◇ (イ) 乾燥/タテ -0.5% ヨコ -0.2% Made in Japan

H	W	~63 1巾(片開き)	~145 2巾	~217 3巾	~290 4巾	~362 5巾	~435 6巾	~507 7巾
~100		14,600	29,200	40,900	53,600	65,400	78,000	89,800
~120		16,300	31,600	45,100	58,600	72,000	86,400	99,900
~140		18,800	36,700	53,600	69,500	86,400	102,500	118,400
~160		19,600	40,000	57,800	75,400	93,200	110,800	128,600
~180		21,300	42,600	61,200	80,500	99,900	118,400	137,900
~200		23,000	45,100	65,400	86,400	106,700	126,900	148,000
~220		23,900	47,600	69,500	91,500	113,500	135,300	157,200
~240		27,300	53,600	78,000	102,500	126,900	151,400	176,600
~260		28,100	56,100	82,200	108,400	133,600	159,700	185,900
~280		29,800	58,600	86,400	113,500	140,400	168,200	195,100
約1.5倍ヒダ		~83	~186	~290	~386	~483		

※片開きはW270cmまで

H	W	~63 1巾(片開き)	~145 2巾	~217 3巾	~290 4巾	~362 5巾	~435 6巾	~507 7巾
~100		15,000	30,000	42,200	55,300	67,500	80,600	92,800
~120		16,800	32,600	46,500	60,400	74,400	89,200	103,200
~140		19,400	37,900	55,300	71,800	89,200	105,900	122,400
~160		20,200	41,200	59,600	77,900	96,300	114,500	132,900
~180		21,900	44,000	63,200	83,200	103,200	122,400	142,500
~200		23,700	46,500	67,500	89,200	110,200	131,200	152,900
~220		24,600	49,100	71,800	94,500	117,200	139,800	162,500
~240		28,200	55,300	80,600	105,900	131,200	156,400	182,500
~260		29,000	57,900	84,900	112,000	138,000	165,100	192,100
~280		30,700	60,400	89,200	117,200	145,100	173,900	201,700
約1.5倍ヒダ		~83	~186	~290	~386	~483		

※片開きはW270cmまで

H	W	~63 1巾(片開き)	~145 2巾	~217 3巾	~290 4巾	~362 5巾	~435 6巾	~507 7巾	~580 8巾
~100		14,200	28,300	39,600	51,900	63,200	75,500	86,800	99,100
~120		15,800	30,700	43,700	56,700	69,700	83,600	96,600	109,700
~140		18,200	35,600	51,900	67,300	83,600	99,100	114,500	130,800
~160		19,000	38,800	55,900	73,000	90,100	107,200	124,300	141,400
~180		20,600	41,300	59,200	77,900	96,600	114,500	133,300	152,000
~200		22,200	43,700	63,200	83,600	103,100	122,700	143,000	162,600
~220		23,100	46,100	67,300	88,500	109,700	130,800	152,000	173,200
~240		26,400	51,900	75,500	99,100	122,700	146,300	170,600	194,200
~260		27,200	54,300	79,500	104,800	129,100	154,400	179,600	204,800
~280		28,800	56,700	83,600	109,700	135,700	162,600	188,600	215,400
約1.5倍ヒダ		~83	~186	~290	~386	~483	~580	~676	~773
フラット前1倍ヒダ		~125	~250	~395	~540				

H	W	~63 1巾(片開き)	~145 2巾	~217 3巾	~290 4巾	~362 5巾	~435 6巾	~507 7巾	~580 8巾
~100		15,900	31,800	44,800	58,800	71,700	85,700	98,700	112,700
~120		17,800	34,500	49,400	64,200	79,000	94,900	109,800	124,800
~140		20,500	40,200	58,800	76,300	94,900	112,700	130,200	148,800
~160		21,400	43,700	63,400	82,800	102,400	121,900	141,500	161,000
~180		23,200	46,600	67,100	88,400	109,800	130,200	151,800	173,100
~200		25,100	49,400	71,700	94,900	117,300	139,600	162,800	185,200
~220		26,200	52,100	76,300	100,600	124,800	148,800	173,100	197,300
~240		29,900	58,800	85,700	112,700	139,600	166,600	194,400	221,400
~260		30,800	61,500	90,300	119,200	147,000	175,800	204,600	233,500

※片開きはW300cmまで

H	W	コード式				ドラム式								
		30~45	~90	~140	~190	30~45	~90	~140	~190	~240	~290	~340	~390	
50~100		17,400	21,300	33,000	36,900	41,600	20,400	24,300	36,000	39,900	44,600	59,100	63,900	68,700
~140		20,500	24,500	38,100	41,900	46,800	23,500	27,500	41,100	44,900	49,800	66,300	71,200	76,100
~180		23,600	27,600	44,700	48,500	53,600	26,600	30,600	47,700	51,500	56,600	76,100	81,100	86,100
~220		26,700	30,800	49,200	53,000	58,300	29,700	33,800	52,200	56,000	61,300	82,700	87,800	93,000
~260		30,300	34,400	55,800	59,600	65,100	33,300	37,400	58,800	62,600	68,100	92,500	97,900	102,900
~300		32,900	37,000	60,300	64,000	69,800	35,900	40,000	63,300	67,000	72,800	99,700	105,000	110,400

※ドラム式: 仕上り巾39cm以下の場合、仕上り丈は200cmまでとなります。

H	W	コード式
50~100		18~30
~140		21,700
~180		25,300
~220		28,300
~260		31,800
~300		33,400

H	W	コード式				ドラム式								
		30~45	~90	~140	~190	30~45	~90	~140	~190	~240	~290	~340	~390	
50~100		20,200	26,500	40,600	47,200	53,600	23,200	29,500	43,600	50,200	56,600	72,200	78,800	85,400
~140		23,600	30,300	46,600	53,600	60,600	26,600	33,300	49,600	56,600	63,600	81,400	88,300	95,100
~180		26,900	34,000	54,300	61,800	69,400	29,900	37,000	57,300	64,800	72,400	93,400	100,900	108,200
~220		30,300	37,800	59,700	67,700	75,800	33,300	40,800	62,700	70,700	78,800	101,900	109,600	117,200
~260		34,300	42,400	67,800	76,400	85,300	37,300	45,400	70,800	79,400	88,300	114,700	122,900	131,000
~300		37,200	45,900	73,600	82,800	92,400	40,200	48,900	76,600	85,800	95,400	124,700	133,300	142,000

※ドラム式: 仕上り巾39cm以下の場合、仕上り丈は200cmまでとなります。

H	W	38mm	片開き/タッセルなし			
~100		~72	~100	~127	~155	~183
~140		17,900	29,400	33,600	35,700	46,600
~180		21,000	35,100	39,300	41,400	56,000
~220		22,900	39,500	43,700	45,800	61,700
~260		24,800	43,200	47,400	49,500	67,900
~300		27,900	49,500	53,700	55,800	77,400
26mm		29,800	53,300	57,500	59,600	83,000
18mm		-2,800	-2,100	-4,900	-4,200	-4,900
18mm		-4,900	-5,600	-9,100	-9,800	-10,500

※生地を伸ばした状態のサイズでご発注ください。

H	W	スプリング・チェーンタイプ				
		30~60	~80	~100	~120	~135
50~80		32,500	35,000	37,000	38,200	39,900
~120		35,700	38,800	40,800	41,900	43,800
~160		38,800	42,600	44,600	45,800	47,100
~200		43,000	46,000	48,200	49,400	50,700
~240			50,200	52,500	53,700	55,100

※丈は巾の3倍までが限度です。
※ロールソフト加工品は非防炎品になります。

ストレートバランス						
H	W	~100	~150	~200	~250	~300
~40		12,800	19,900	24,300	28,700	36,700

※マジックテープ仕様・裏面スポンジ付の価格になります。

三ツ山・箱ヒダバランス (約2.5倍ヒダ)						
H	W	~100	~150	~200	~250	~300
~40		12,900	18,400	24,000	30,600	36,200

※マジックテープ仕様の価格になります。

TM-54209~54216



巾 ◇ 150cm 価格 ◇ 5,250円/m
組成 ◇ ポリエステル100%

リポート ◇ タテ 30.3cm ヨコ 13.6cm
寸法変化率 ◇ 水洗い/タテ -0.2% ヨコ -0.2%
ドライ/タテ -0.3% ヨコ 0.3%

取扱い表示 ◇ リ-30 30 40 50 60 70 80 90 100
防炎性能 ◇ (イ) あて布使用
Made in Japan

H	W	~67 1巾(片開き)	~150 2巾	~225 3巾	~300 4巾	~375 5巾	~450 6巾	~525 7巾
~100		13,500	26,200	37,200	48,300	59,200	70,300	81,300
~120		15,700	30,600	43,800	57,100	70,300	83,500	97,400
~140		15,700	30,600	43,800	57,100	70,300	83,500	97,400
~160		17,900	35,000	50,400	65,900	81,300	97,400	112,900
~180		20,100	39,400	57,100	74,700	93,000	110,700	128,300
~200		20,100	39,400	57,100	74,700	93,000	110,700	128,300
~220		22,300	43,800	63,600	83,500	104,100	123,900	143,800
~240		24,600	48,300	70,300	93,000	115,100	137,100	160,000
~260		24,600	48,300	70,300	93,000	115,100	137,100	160,000
~280		26,700	52,700	76,800	101,800	126,200	150,300	175,300
約1.5倍ヒダ		~88	~200	~300	~400	~500		

※片開きはW270cmまで

H	W	~67 1巾(片開き)	~150 2巾	~225 3巾	~300 4巾	~375 5巾	~450 6巾	~525 7巾
~100		13,900	27,100	38,500	50,100	61,500	73,000	84,400
~120		16,300	31,700	45,500	59,300	73,000	86,800	101,300
~140		16,300	31,700	45,500	59,300	73,000	86,800	101,300
~160		18,500	36,300	52,300	68,500	84,400	101,300	117,400
~180		20,900	40,900	59,300	77,600	96,700	115,000	133,400
~200		20,900	40,900	59,300	77,600	96,700	115,000	133,400
~220		23,100	45,500	66,100	86,800	108,200	128,800	149,500
~240		25,500	50,100	73,000	96,700	119,600	142,600	166,400
~260		25,500	50,100	73,000	96,700	119,600	142,600	166,400
~280		27,700	54,700	79,800	105,900	131,200	156,300	182,400
約1.5倍ヒダ		~88	~200	~300	~400	~500		

※片開きはW270cmまで

H	W	~67 1巾(片開き)	~150 2巾	~225 3巾	~300 4巾	~375 5巾	~450 6巾	~525 7巾	~600 8巾
~100		13,000	25,300	35,800	46,400	56,900	67,600	78,100	89,400
~120		15,200	29,500	42,200	54,900	67,600	80,300	93,600	106,300
~140		15,200	29,500	42,200	54,900	67,600	80,300	93,600	106,300
~160		17,200	33,700	48,500	63,300	78,100	93,600	108,500	123,200
~180		19,400	38,000	54,900	71,800	89,400	106,300	123,200	140,100
~200		19,400	38,000	54,900	71,800	89,400	106,300	123,200	140,100
~220		21,400	42,200	61,200	80,300	100,000	119,000	138,100	157,800
~240		23,600	46,400	67,600	89,400	110,500	131,700	153,600	174,700
~260		23,600	46,400	67,600	89,400	110,500	131,700	153,600	174,700
~280		25,700	50,600	73,800	97,800	121,100	144,300	168,300	191,600
約1.5倍ヒダ		~88	~200	~300	~400	~500	~600	~700	~800
フラット前ヒダ		~130	~260	~410	~560				

H	W	~67 1巾(片開き)	~150 2巾	~225 3巾	~300 4巾	~375 5巾	~450 6巾	~525 7巾	~600 8巾
~100		14,900	29,000	41,300	53,800	66,000	78,500	90,800	104,000
~120		17,500	34,000	48,800	63,700	78,500	93,400	108,900	123,800
~140		17,500	34,000	48,800	63,700	78,500	93,400	108,900	123,800
~160		19,800	38,900	56,100	73,600	90,800	108,900	126,400	143,600
~180		22,400	43,900	63,700	83,500	104,000	123,800	143,600	163,400
~200		22,400	43,900	63,700	83,500	104,000	123,800	143,600	163,400
~220		24,800	48,800	71,000	93,400	116,500	138,600	161,000	184,100
~240		27,400	53,800	78,500	104,000	128,700	153,500	179,200	203,900
~260		27,400	53,800	78,500	104,000	128,700	153,500	179,200	203,900

※片開きはW300cmまで

		コード式				ドラム式								
H	W	30~45	~90	~140	~190	~240	30~45	~90	~140	~190	~240	~290	~340	~390
50~100		16,100	20,100	24,600	33,900	38,600	19,100	23,100	27,600	36,900	41,600	48,900	59,100	63,900
~140		19,700	23,700	28,500	40,500	45,400	22,700	26,700	31,500	43,500	48,400	56,100	69,100	74,000
~180		21,900	26,000	31,000	44,300	49,500	24,900	29,000	34,000	47,300	52,500	60,300	74,800	79,800
~220		24,200	28,300	33,500	48,200	53,600	27,200	31,300	36,500	51,200	56,600	64,700	80,600	85,700
~260		27,700	31,900	37,300	54,700	60,300	30,700	34,900	40,300	57,700	63,300	71,600	90,600	95,600
~300		30,000	34,200	39,800	58,600	64,400	33,000	37,200	42,800	61,600	67,400	76,000	96,200	101,600

※ドラム式: 仕上り巾39cm以下の場合、仕上り丈は200cmまでとなります。

		コード式
H	W	18~30
50~100		20,500
~140		24,500
~180		26,800
~220		29,500
~240		31,800

		コード式				ドラム式								
H	W	30~45	~90	~140	~190	~240	30~45	~90	~140	~190	~240	~290	~340	~390
50~100		18,900	25,100	31,800	44,000	50,400	21,900	28,100	34,800	47,000	53,400	61,600	73,800	80,400
~140		22,800	29,500	36,600	52,100	59,100	25,800	32,500	39,600	55,100	62,100	70,600	86,100	92,900
~180		25,200	32,300	39,900	57,400	64,900	28,200	35,300	42,900	60,400	67,900	76,800	94,300	101,600
~220		27,700	35,200	43,300	62,600	70,800	30,700	38,200	46,300	65,600	73,800	83,000	102,000	109,700
~260		31,600	39,800	48,400	71,300	80,100	34,600	42,800	51,400	74,300	83,100	92,900	115,200	123,300
~300		34,300	43,000	52,200	77,000	86,600	37,300	46,000	55,200	80,000	89,600	99,900	124,100	132,800

※ドラム式: 仕上り巾39cm以下の場合、仕上り丈は200cmまでとなります。

		スプリング・チェーンタイプ				
H	W	30~60	~80	~100	~120	~140
50~80		31,300	33,800	35,800	37,000	38,700
~120		34,900	38,000	40,000	41,100	43,000
~160		37,300	41,100	43,100	44,300	45,600
~200		40,700	43,700	45,900	47,100	48,400
~240			47,900	50,200	51,400	52,800

※丈は巾の3倍までが限度です。
※ロールソフト加工品は非防災品になります。

		38mm (片開き/タッセルなし)					
H	W	~72	~100	~127	~155	~183	
~100		17,100	27,300	31,500	33,600	43,800	
~140		18,700	30,600	34,800	36,900	48,700	
~180		22,000	37,000	41,200	43,300	58,400	
~220		23,600	40,300	44,500	46,600	63,200	
~260		25,200	43,500	47,700	49,800	68,100	
~300		28,500	50,000	54,200	56,300	77,800	
26mm		-2,800	-2,100	-4,900	-4,200	-4,900	
18mm		-4,900	-5,600	-9,100	-9,800	-10,500	

※生地を伸ばした状態のサイズでご発注ください。

		ストレートバランス				
H	W	~100	~150	~200	~250	~300
~40		11,400	18,700	23,100	27,500	34,400

※マジックテープ仕様・裏面スポンジ付の価格になります。

H	W	~100	~150	~200	~250	~300
~40		12,100	17,400	22,700	29,000	30,500

※マジックテープ仕様の価格になります。

遮光

TM-54221~54223



巾 ◇ 145 cm 価格 ◇ 6,100円/m
組成 ◇ ポリエステル100%

リポート ◇ タテ cm ヨコ cm
寸法変化率 ◇ 水洗い/タテ 0.2% ヨコ 0.0%
ドライ/タテ -0.2% ヨコ 0.0%

取扱い表示 ◇ リ-30
防炎性能 ◇ (イ) あて布使用
Made in Japan

H	W	~63 1巾(片開き)	~145 2巾	~217 3巾	~290 4巾	~362 5巾	~435 6巾	~507 7巾
~100		13,200	26,500	37,800	49,200	60,700	72,000	83,300
~120		14,800	29,600	42,800	55,700	68,700	81,700	94,700
~140		16,500	32,900	47,500	62,200	76,900	91,500	106,200
~160		18,100	36,200	52,500	68,700	85,000	101,200	117,500
~180		19,800	39,500	57,400	75,300	93,200	110,900	128,800
~200		21,400	42,800	62,200	81,700	101,200	120,800	140,300
~220		23,000	45,900	67,100	88,300	109,400	130,500	151,700
~240		24,700	49,200	72,000	94,700	117,500	140,300	163,000
~260		26,300	52,500	76,900	101,200	125,700	150,000	174,500
~280		27,800	55,700	81,700	107,800	133,800	159,700	185,800
約1.5倍ヒダ		~83	~186	~290	~386	~483		

※片開きはW270cmまで

H	W	~63 1巾(片開き)	~145 2巾	~217 3巾	~290 4巾	~362 5巾	~435 6巾	~507 7巾
~100		13,600	27,300	39,100	50,800	62,700	74,400	86,200
~120		15,300	30,600	44,200	57,600	71,000	84,500	97,900
~140		17,000	34,000	49,100	64,200	79,500	94,700	109,800
~160		18,700	37,400	54,200	71,000	87,900	104,700	121,600
~180		20,400	40,800	59,300	77,800	96,400	114,800	133,300
~200		22,100	44,200	64,200	84,500	104,700	125,000	145,200
~220		23,800	47,400	69,300	91,300	113,200	135,000	156,900
~240		25,500	50,800	74,400	97,900	121,600	145,200	168,700
~260		27,200	54,200	79,500	104,700	130,100	155,200	180,600
~280		28,700	57,600	84,500	111,500	138,400	165,300	192,300
約1.5倍ヒダ		~83	~186	~290	~386	~483		

※片開きはW270cmまで

H	W	~63 1巾(片開き)	~145 2巾	~217 3巾	~290 4巾	~362 5巾	~435 6巾	~507 7巾	~580 8巾
~100		12,800	25,700	36,600	47,600	58,600	69,600	80,500	91,400
~120		14,400	28,700	41,400	53,900	66,400	78,900	91,400	104,100
~140		16,000	31,900	46,000	60,100	74,300	88,400	102,500	116,600
~160		17,500	35,000	50,700	66,400	82,100	97,800	113,400	129,100
~180		19,100	38,200	55,500	72,700	90,000	107,100	124,400	141,600
~200		20,700	41,400	60,100	78,900	97,800	116,600	135,400	154,200
~220		22,300	44,400	64,800	85,200	105,700	126,000	146,400	166,800
~240		23,900	47,600	69,600	91,400	113,400	135,400	157,300	179,300
~260		25,400	50,700	74,300	97,800	121,300	144,800	168,400	191,800
~280		26,900	53,900	78,900	104,100	129,100	154,200	179,300	204,400
約1.5倍ヒダ		~83	~186	~290	~386	~483	~580	~676	~773
フラット前ヒダ		~125	~250	~395	~540				

H	W	~63 1巾(片開き)	~145 2巾	~217 3巾	~290 4巾	~362 5巾	~435 6巾	~507 7巾	~580 8巾
~100		14,400	29,000	41,500	54,000	66,800	79,300	91,900	104,400
~120		16,200	32,400	47,000	61,300	75,700	90,000	104,400	119,000
~140		18,000	36,000	52,200	68,400	84,800	101,000	117,100	133,300
~160		19,900	39,700	57,700	75,700	93,700	111,700	129,700	147,700
~180		21,700	43,300	63,100	83,000	102,800	122,400	142,200	162,000
~200		23,500	47,000	68,400	90,000	111,700	133,300	155,000	176,400
~220		25,300	50,400	73,900	97,300	120,800	144,000	167,500	191,000
~240		27,100	54,000	79,300	104,400	129,700	155,000	180,000	205,300
~260		29,000	57,700	84,800	111,700	138,800	165,700	192,800	219,700

※片開きはW300cmまで

		コード式				ドラム式							
H	W	30~45	~90	~140	~240	30~45	~90	~140	~190	~240	~290	~340	~390
50~100		16,500	20,500	31,300	35,200	19,500	23,500	34,300	38,200	42,900	56,500	61,300	66,100
~140		19,500	23,500	36,700	40,500	22,500	26,500	39,700	43,500	48,500	64,500	69,400	74,300
~180		22,500	26,500	42,000	45,900	25,500	29,500	45,000	48,900	54,000	72,300	77,300	82,400
~220		25,500	29,600	47,400	51,200	28,500	32,600	50,400	54,200	59,600	80,300	85,400	90,600
~260		28,400	32,600	52,700	56,500	31,400	35,600	55,700	59,500	65,100	88,100	93,600	98,600
~300		31,500	35,700	58,100	61,900	34,500	38,700	61,100	64,900	70,700	96,100	101,400	106,800

※ドラム式: 仕上り巾39cm以下の場合、仕上り丈は200cmまでとなります。

		コード式	
H	W	18~30	
50~100		20,900	
~140		24,400	
~180		27,300	
~220		30,800	
~240		32,700	

		コード式				ドラム式							
H	W	30~45	~90	~140	~240	30~45	~90	~140	~190	~240	~290	~340	~390
50~100		19,300	25,600	38,800	45,400	22,300	28,600	41,800	48,400	54,800	69,500	76,100	82,700
~140		22,600	29,300	45,100	52,200	25,600	32,300	48,100	55,200	62,200	79,500	86,400	93,300
~180		25,800	32,900	51,400	59,000	28,800	35,900	54,400	62,000	69,600	89,400	97,000	104,300
~220		29,000	36,600	57,800	65,800	32,000	39,600	60,800	68,800	76,900	99,400	107,000	114,700
~260		32,400	40,500	64,500	73,200	35,400	43,500	67,500	76,200	85,000	110,200	118,300	126,500
~300		35,800	44,500	71,300	80,500	38,800	47,500	74,300	83,500	93,100	120,900	129,600	138,200

※ドラム式: 仕上り巾39cm以下の場合、仕上り丈は200cmまでとなります。

		38mm (片開き/タッセルなし)					
H	W	~72	~100	~127	~155	~183	
~100		16,900	27,500	31,700	33,800	44,300	
~140		19,300	32,300	36,500	38,600	51,500	
~180		21,700	37,100	41,300	43,400	58,800	
~220		24,200	41,900	46,100	48,200	66,100	
~260		26,600	46,800	51,000	53,100	73,300	
~300		29,000	51,700	55,900	58,000	80,600	
26mm		-2,800	-2,100	-4,900	-4,200	-4,900	
18mm		-4,900	-5,600	-9,100	-9,800	-10,500	

※生地を伸ばした状態のサイズでご発注ください。

		スプリング・チェーンタイプ				
H	W	30~60	~80	~100	~120	~135
50~80		31,700	34,200	36,200	37,400	39,100
~120		34,800	37,900	39,900	41,000	42,900
~160		37,800	41,600	43,600	44,800	46,100
~200		42,000	45,000	47,200	48,400	49,700
~240			48,500	50,800	52,000	53,400

※丈は巾の3倍までが限度です。
※ロールソフト加工品は非防災品になります。

		ストレートバランス				
H	W	~100	~150	~200	~250	~300
~40		11,800	19,100	23,500	27,900	35,200

※マジックテープ仕様・裏面スポンジ付の価格になります。

H	W	~100	~150	~200	~250	~300
~40		11,000	15,900	20,800	26,700	31,600

※マジックテープ仕様の価格になります。

プレーン		パイピング	
サイズ	価格	サイズ	価格
40x40	7,100	40x40	8,100
45x45	8,500	45x45	9,500
フリール付			
サイズ	価格	サイズ	価格
40x40	11,900	40x40	11,400
45x45	13,800	45x45	13,300

※中材込みの価格になります。

遮光

TM-54224・54225

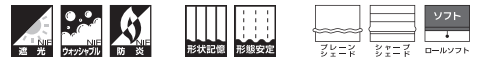

巾 ◇ 100cm 価格 ◇ 3,200円/m リポート ◇ タテ60.0cm ヨコ50.0cm 取扱い表示 ◇ リ-30 40 防炎性能 ◇ (イ) であて布使用
 組成 ◇ ポリエステル100% 寸法変化率 ◇ 水洗い/タテ 0.0% ヨコ -0.1% ドライ/タテ -1.0% ヨコ -0.8% Made in Japan

H	W	~44 1巾(片開き)	~100 2巾	~150 3巾	~200 4巾	~250 5巾	~300 6巾	~350 7巾	~400 8巾
~100		9,600	19,100	27,400	35,600	43,900	52,200	60,500	68,800
~120		9,600	19,100	27,400	35,600	43,900	52,200	60,500	68,800
~140		9,600	19,100	27,400	35,600	43,900	52,200	60,500	68,800
~160		12,300	24,600	35,600	46,700	57,700	68,800	79,800	90,800
~180		12,300	24,600	35,600	46,700	57,700	68,800	79,800	90,800
~200		12,300	24,600	35,600	46,700	57,700	68,800	79,800	90,800
~220		15,100	30,100	43,900	57,700	71,500	85,300	99,100	112,900
~240		15,100	30,100	43,900	57,700	71,500	85,300	99,100	112,900
~260		15,100	30,100	43,900	57,700	71,500	85,300	99,100	112,900
~280		17,800	35,600	52,200	68,800	85,300	101,900	118,400	135,000
約1.5倍ヒダ		~56	~120	~200	~266	~333	~400	~466	~533

※片開きはW270cmまで

H	W	~44 1巾(片開き)	~100 2巾	~150 3巾	~200 4巾	~250 5巾	~300 6巾	~350 7巾	~400 8巾
~100		9,900	19,800	28,400	37,100	45,700	54,400	63,000	71,600
~120		9,900	19,800	28,400	37,100	45,700	54,400	63,000	71,600
~140		9,900	19,800	28,400	37,100	45,700	54,400	63,000	71,600
~160		12,800	25,600	37,100	48,600	60,100	71,600	83,200	94,700
~180		12,800	25,600	37,100	48,600	60,100	71,600	83,200	94,700
~200		12,800	25,600	37,100	48,600	60,100	71,600	83,200	94,700
~220		15,700	31,300	45,700	60,100	74,500	88,900	103,300	117,700
~240		15,700	31,300	45,700	60,100	74,500	88,900	103,300	117,700
~260		15,700	31,300	45,700	60,100	74,500	88,900	103,300	117,700
~280		18,600	37,100	54,400	71,600	88,900	106,200	123,500	140,800
約1.5倍ヒダ		~56	~120	~200	~266	~333	~400	~466	~533

※片開きはW270cmまで

H	W	~44 1巾(片開き)	~100 2巾	~150 3巾	~200 4巾	~250 5巾	~300 6巾	~350 7巾	~400 8巾
~100		9,200	18,400	26,300	34,200	42,100	50,000	58,000	65,900
~120		9,200	18,400	26,300	34,200	42,100	50,000	58,000	65,900
~140		9,200	18,400	26,300	34,200	42,100	50,000	58,000	65,900
~160		11,800	23,600	34,200	44,800	55,300	65,900	76,400	87,000
~180		11,800	23,600	34,200	44,800	55,300	65,900	76,400	87,000
~200		11,800	23,600	34,200	44,800	55,300	65,900	76,400	87,000
~220		14,500	28,900	42,100	55,300	68,500	81,700	94,900	108,100
~240		14,500	28,900	42,100	55,300	68,500	81,700	94,900	108,100
~260		14,500	28,900	42,100	55,300	68,500	81,700	94,900	108,100
~280		17,100	34,200	50,000	65,900	81,700	97,600	113,400	129,200
約1.5倍ヒダ		~56	~120	~200	~266	~333	~400	~466	~533
フラット前ヒダ		~80	~160	~260	~360	~460	~560		

H	W	~44 1巾(片開き)	~100 2巾	~150 3巾	~200 4巾	~250 5巾	~300 6巾	~350 7巾	~400 8巾
~100		10,600	21,200	30,600	40,000	49,300	58,700	68,000	77,400
~120		10,600	21,200	30,600	40,000	49,300	58,700	68,000	77,400
~140		10,600	21,200	30,600	40,000	49,300	58,700	68,000	77,400
~160		13,800	27,500	40,000	52,400	64,900	77,400	89,900	102,400
~180		13,800	27,500	40,000	52,400	64,900	77,400	89,900	102,400
~200		13,800	27,500	40,000	52,400	64,900	77,400	89,900	102,400
~220		16,900	33,700	49,300	64,900	80,500	96,100	111,700	127,300
~240		16,900	33,700	49,300	64,900	80,500	96,100	111,700	127,300
~260		16,900	33,700	49,300	64,900	80,500	96,100	111,700	127,300
~280		16,900	33,700	49,300	64,900	80,500	96,100	111,700	127,300

※片開きはW300cmまで

H	W	コード式				ドラム式								
		30~45	~90	~140	~190	30~45	~90	~140	~190	~240	~290	~340	~390	
50~100		13,400	17,500	25,300	29,400	37,300	16,400	20,500	28,300	32,400	40,300	47,600	55,600	60,400
~140		16,000	20,100	29,800	33,800	43,600	19,000	23,100	32,800	36,800	46,600	54,200	64,100	69,000
~180		18,500	22,600	34,300	38,300	49,900	21,500	25,600	37,300	41,300	52,900	60,700	72,300	77,300
~220		19,400	23,600	35,400	39,500	51,300	22,400	26,600	38,400	42,500	54,300	62,300	74,100	79,200
~260		21,900	26,200	39,900	44,000	57,600	24,900	29,200	42,900	47,000	60,600	68,800	82,500	87,500
~300		24,400	28,800	44,300	48,400	63,900	27,400	31,800	47,300	51,400	66,900	75,500	90,700	96,100

※ドラム式: 仕上り巾39cm以下の場合、仕上り丈は200cmまでとなります。

H	W	コード式
50~100		18~30
~140		18,100
~180		21,200
~220		23,700
~260		25,200
~300		27,700

H	W	コード式				ドラム式								
		30~45	~90	~140	~190	30~45	~90	~140	~190	~240	~290	~340	~390	
50~100		16,200	22,500	32,500	39,100	49,000	19,200	25,500	35,500	42,100	52,000	60,100	70,200	76,700
~140		19,000	25,700	37,900	45,000	57,100	22,000	28,700	40,900	48,000	60,100	68,700	80,800	87,600
~180		21,700	28,900	43,300	50,900	65,300	24,700	31,900	46,300	53,900	68,300	77,200	91,700	99,000
~220		22,800	30,300	45,300	53,300	68,300	25,800	33,300	48,300	56,300	71,300	80,600	95,200	102,800
~260		25,600	33,800	51,100	59,700	77,200	28,600	36,800	54,100	62,700	80,200	90,000	106,700	114,900
~300		28,600	37,300	56,900	66,100	86,100	31,600	40,300	59,900	69,100	89,100	99,300	118,300	127,000

※ドラム式: 仕上り巾39cm以下の場合、仕上り丈は200cmまでとなります。

H	W	(片開き/タッセルなし)				
38mm		~72	~100	~127	~155	~183
~100		20,500	22,600	32,900	35,000	43,100
~140		20,500	22,600	32,900	35,000	43,100
~180		24,600	26,700	38,900	41,000	51,200
~220		28,600	30,700	45,000	47,100	59,300
~260		28,600	30,700	45,000	47,100	59,300
~300		32,600	34,700	51,000	53,100	67,300
26mm		-2,800	-2,100	-4,900	-4,200	-4,900
18mm		-4,900	-5,600	-9,100	-9,800	-10,500

※生地を伸ばした状態のサイズでご発注ください。

H	W	スプリング・チェーンタイプ		
		30~60	~80	~90
50~80		28,900	31,400	33,400
~120		31,600	34,700	36,700
~160		34,200	38,000	40,000
~200		36,400	39,400	41,600
~240			42,500	44,800

※丈は巾の3倍までが限度です。
 ※ロールソフト加工品は非防炎品になります。

ストレートバランス						
H	W	~100	~150	~200	~250	~300
~40		11,900	16,300	22,300	26,700	32,600

※マジックテープ仕様・裏面スポンジ付の価格になります。

三ツ山・箱ヒダバランス (約2.5倍ヒダ)						
H	W	~100	~150	~200	~250	~300
~40		13,400	17,900	22,500	31,200	35,700

※マジックテープ仕様の価格になります。

TM-54226・54227

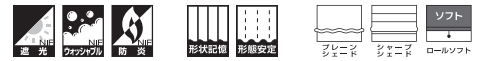

巾 ◇ 146 cm 価格 ◇ 5,700 円/m
組成 ◇ ポリエステル100%

リポート ◇ タテ 23.0 cm ヨコ 9.7 cm
寸法変化率 ◇ 水洗い/タテ -0.3% ヨコ -0.1%
ドライ/タテ -0.5% ヨコ -0.5%

取扱い表示 ◇ リ-30 30 40 50 60 70 80 90 100
防炎性能 ◇ (イ) あて布使用
Made in Japan

H	W	~64 1巾(片開き)	~146 2巾	~219 3巾	~292 4巾	~365 5巾	~438 6巾	~511 7巾
~100		12,600	25,200	36,000	46,900	57,000	67,800	78,700
~120		15,000	29,100	41,500	53,900	66,200	78,700	91,000
~140		16,500	32,200	46,900	60,800	74,700	89,500	103,400
~160		18,100	36,000	52,300	67,800	84,100	100,400	115,900
~180		19,700	39,100	57,000	74,700	92,600	110,300	128,200
~200		21,900	43,000	62,400	82,500	101,800	121,200	141,400
~220		23,500	46,900	67,800	89,500	110,300	132,000	153,700
~240		25,000	50,000	73,200	96,400	119,700	142,900	166,200
~260		25,000	50,000	73,200	96,400	119,700	142,900	166,200
~280		27,300	53,900	78,700	103,400	128,200	153,700	178,500
約1.5倍ヒダ		~84	~188	~292	~389	~486		

※片開きはW270cmまで

H	W	~64 1巾(片開き)	~146 2巾	~219 3巾	~292 4巾	~365 5巾	~438 6巾	~511 7巾
~100		13,000	26,000	37,200	48,600	59,000	70,200	81,500
~120		15,500	30,000	43,000	55,800	68,600	81,500	94,300
~140		17,100	33,300	48,600	63,000	77,400	92,700	107,100
~160		18,700	37,200	54,200	70,200	87,100	104,100	120,100
~180		20,300	40,500	59,000	77,400	96,000	114,300	132,900
~200		22,700	44,400	64,600	85,500	105,500	125,700	146,600
~220		24,300	48,600	70,200	92,700	114,300	136,900	159,400
~240		25,900	51,800	75,800	99,900	124,100	148,200	172,300
~260		25,900	51,800	75,800	99,900	124,100	148,200	172,300
~280		28,300	55,800	81,500	107,100	132,900	159,400	185,100
約1.5倍ヒダ		~84	~188	~292	~389	~486		

※片開きはW270cmまで

H	W	~64 1巾(片開き)	~146 2巾	~219 3巾	~292 4巾	~365 5巾	~438 6巾	~511 7巾	~584 8巾
~100		12,200	24,400	34,800	45,300	55,000	65,400	75,900	86,200
~120		14,500	28,100	40,100	52,000	63,900	75,900	87,700	99,600
~140		16,000	31,100	45,300	58,700	72,000	86,200	99,600	113,800
~160		17,500	34,800	50,500	65,400	81,000	96,700	111,600	127,200
~180		19,000	37,800	55,000	72,000	89,200	106,300	123,500	140,700
~200		21,200	41,500	60,200	79,500	98,100	116,800	136,200	154,800
~220		22,700	45,300	65,400	86,200	106,300	127,200	148,100	168,300
~240		24,200	48,300	70,500	92,900	115,300	137,700	160,100	182,300
~260		24,200	48,300	70,500	92,900	115,300	137,700	160,100	182,300
~280		26,400	52,000	75,900	99,600	123,500	148,100	171,900	195,800
約1.5倍ヒダ		~84	~188	~292	~389	~486	~584	~681	~778
フラット前ヒダ		~126	~252	~398	~544				

H	W	~64 1巾(片開き)	~146 2巾	~219 3巾	~292 4巾	~365 5巾	~438 6巾	~511 7巾	~584 8巾
~100		13,800	27,700	39,700	51,800	63,100	75,000	87,200	99,200
~120		16,500	31,900	45,900	59,600	73,300	87,200	100,900	114,700
~140		18,200	35,400	51,800	67,300	82,800	99,200	114,700	131,100
~160		20,000	39,700	57,800	75,000	93,200	111,400	128,600	146,500
~180		21,700	43,100	63,100	82,800	102,700	122,400	142,300	162,200
~200		24,200	47,400	69,000	91,500	112,900	134,600	157,000	178,400
~220		25,900	51,800	75,000	99,200	122,400	146,500	170,700	194,100
~240		27,700	55,300	81,000	106,900	132,800	158,700	184,600	210,300
~260		27,700	55,300	81,000	106,900	132,800	158,700	184,600	210,300

※片開きはW300cmまで

		コード式				ドラム式								
H	W	30~45	~90	~140	~190	~240	30~45	~90	~140	~190	~240	~290	~340	~390
50~100		17,100	21,000	32,500	36,300	41,000	20,100	24,000	35,500	39,300	44,000	58,200	63,000	67,800
~140		19,400	23,500	36,100	39,900	44,900	22,400	26,500	39,100	42,900	47,900	63,400	68,300	73,200
~180		22,300	26,300	41,600	45,500	50,600	25,300	29,300	44,600	48,500	53,600	71,700	76,700	81,800
~220		25,700	29,700	47,200	51,000	56,400	28,700	32,700	50,200	54,000	59,400	79,800	84,900	90,000
~260		28,500	32,600	52,800	56,600	62,100	31,500	35,600	55,800	59,600	65,100	88,100	93,600	98,600
~300		30,800	35,100	56,400	60,200	66,000	33,800	38,100	59,400	63,200	69,000	93,300	98,600	104,000

※ドラム式: 仕上り巾39cm以下の場合、仕上り丈は200cmまでとなります。

		コード式	
H	W	18~30	
50~100		18~30	21,400
~140			24,300
~180			27,100
~220			30,900
~240			32,800

		コード式				ドラム式								
H	W	30~45	~90	~140	~190	~240	30~45	~90	~140	~190	~240	~290	~340	~390
50~100		19,900	26,200	40,000	46,600	53,000	22,900	29,200	43,000	49,600	56,000	71,300	77,900	84,500
~140		22,500	29,200	44,500	51,600	58,500	25,500	32,200	47,500	54,600	61,500	78,300	85,200	92,000
~180		25,600	32,700	51,000	58,600	66,100	28,600	35,700	54,000	61,600	69,100	88,800	96,400	103,600
~220		29,200	36,800	57,600	65,600	73,800	32,200	39,800	60,600	68,600	76,800	98,900	106,500	114,200
~260		32,400	40,600	64,600	73,200	82,100	35,400	43,600	67,600	76,200	85,100	110,200	118,400	126,500
~300		35,100	43,800	69,500	78,700	88,300	38,100	46,800	72,500	81,700	91,300	118,000	126,600	135,300

※ドラム式: 仕上り巾39cm以下の場合、仕上り丈は200cmまでとなります。

		38mm (片開き/タッセルなし)					
H	W	~72	~100	~127	~155	~183	
~100		16,400	26,600	30,800	32,900	43,000	
~140		19,400	31,700	35,900	38,000	51,000	
~180		21,700	36,900	41,100	43,200	58,500	
~220		24,500	42,600	46,800	48,900	66,500	
~260		25,600	44,900	49,100	51,200	70,500	
~300		28,500	50,100	54,300	56,400	78,500	
26mm		-2,800	-2,100	-4,900	-4,200	-4,900	
18mm		-4,900	-5,600	-9,100	-9,800	-10,500	

※生地を伸ばした状態のサイズでご発注ください。

		スプリング・チェーンタイプ				
H	W	30~60	~80	~100	~120	~136
50~80		32,200	34,700	36,700	37,900	39,600
~120		34,700	37,800	39,800	40,900	42,800
~160		37,600	41,400	43,400	44,600	45,900
~200		42,100	45,100	47,300	48,500	49,800
~240			48,500	50,800	52,000	53,400

※丈は巾の3倍までが限度です。
※ロールソフト加工品は非防災品になります。

		ストレートバランス				
H	W	~100	~150	~200	~250	~300
~40		12,000	19,600	24,000	28,400	36,000

※マジックテープ仕様・裏面スポンジ付の価格になります。

H	W	~100	~150	~200	~250	~300
~40		10,500	15,200	19,900	25,600	30,300

※マジックテープ仕様の価格になります。

遮光

TM-54228・54229

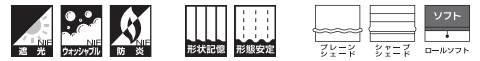

巾 ◇ 148cm 価格 ◇ 4,800円/m リポート ◇ タテ 24.3cm ヨコ 9.9cm 取扱表示 ◇ リ-30 40 防炎性能 ◇ (イ) であて布使用
 組成 ◇ ポリエステル100% 寸法変化率 ◇ 水洗い/タテ -0.2% ヨコ -0.2% ドライ/タテ 0.0% ヨコ 0.2% Made in Japan

H	W	~65 1巾(片開き)	~148 2巾	~222 3巾	~296 4巾	~370 5巾	~444 6巾	~518 7巾
~100		11,900	23,700	33,400	43,700	53,300	63,600	73,300
~120		13,300	26,500	38,100	49,900	61,600	73,300	84,900
~140		15,400	30,000	43,700	56,700	70,500	83,500	96,600
~160		16,800	33,400	48,600	63,600	78,800	93,800	108,200
~180		16,800	33,400	48,600	63,600	78,800	93,800	108,200
~200		18,800	36,900	53,300	70,500	87,100	103,500	120,700
~220		20,200	40,300	58,800	76,600	95,200	113,800	132,300
~240		22,200	43,700	63,600	83,500	103,500	123,400	144,000
~260		23,500	47,200	68,500	90,400	111,800	133,700	155,800
~280		24,900	49,900	73,300	96,600	120,700	144,000	167,400
約1.5倍ヒダ		~86	~192	~296	~394	~493		

※片開きはW270cmまで

H	W	~65 1巾(片開き)	~148 2巾	~222 3巾	~296 4巾	~370 5巾	~444 6巾	~518 7巾
~100		12,300	24,600	34,700	45,400	55,500	66,200	76,300
~120		13,800	27,500	39,600	52,000	64,100	76,300	88,400
~140		16,000	31,200	45,400	59,000	73,400	87,000	100,600
~160		17,400	34,700	50,500	66,200	82,000	97,700	112,800
~180		17,400	34,700	50,500	66,200	82,000	97,700	112,800
~200		19,500	38,400	55,500	73,400	90,700	107,800	125,700
~220		21,000	41,900	61,200	79,800	99,200	118,500	137,900
~240		23,000	45,400	66,200	87,000	107,800	128,600	150,000
~260		24,500	49,100	71,300	94,200	116,400	139,300	162,400
~280		25,900	52,000	76,300	100,600	125,700	150,000	174,500
約1.5倍ヒダ		~86	~192	~296	~394	~493		

※片開きはW270cmまで

H	W	~65 1巾(片開き)	~148 2巾	~222 3巾	~296 4巾	~370 5巾	~444 6巾	~518 7巾	~592 8巾
~100		11,400	22,800	32,100	41,900	51,200	61,000	70,200	80,100
~120		12,800	25,500	36,600	47,900	59,100	70,200	81,400	92,600
~140		14,800	28,800	41,900	54,400	67,600	80,100	92,600	105,800
~160		16,100	32,100	46,600	61,000	75,500	89,900	103,700	118,200
~180		16,100	32,100	46,600	61,000	75,500	89,900	103,700	118,200
~200		18,000	35,400	51,200	67,600	83,400	99,200	115,600	131,400
~220		19,400	38,700	56,400	73,500	91,200	109,000	126,800	143,900
~240		21,300	41,900	61,000	80,100	99,200	118,200	137,900	157,000
~260		22,600	45,300	65,700	86,700	107,100	128,100	149,200	169,500
~280		23,900	47,900	70,200	92,600	115,600	137,900	160,400	182,700
約1.5倍ヒダ		~86	~192	~296	~394	~493	~592	~690	~789
フラット前1倍ヒダ		~128	~256	~404	~552				

H	W	~65 1巾(片開き)	~148 2巾	~222 3巾	~296 4巾	~370 5巾	~444 6巾	~518 7巾	~592 8巾
~100		13,200	26,400	37,300	48,900	59,800	71,400	82,300	93,900
~120		14,800	29,500	42,600	56,000	69,200	82,300	95,500	108,600
~140		17,200	33,500	48,900	63,600	79,200	93,900	108,600	124,200
~160		18,800	37,300	54,400	71,400	88,600	105,500	121,800	139,000
~180		18,800	37,300	54,400	71,400	88,600	105,500	121,800	139,000
~200		21,000	41,300	59,800	79,200	97,900	116,400	135,800	154,600
~220		22,600	45,100	66,000	86,100	107,100	128,000	149,000	169,300
~240		24,800	48,900	71,400	93,900	116,400	139,000	162,200	184,700
~260		26,400	52,900	77,000	101,700	125,800	150,600	175,500	199,400

※片開きはW300cmまで

		コード式				ドラム式								
H	W	30~45	~90	~140	~190	~240	30~45	~90	~140	~190	~240	~290	~340	~390
50~100		15,500	19,600	29,100	33,000	37,700	18,500	22,600	32,100	36,000	40,700	52,900	57,700	62,500
~140		18,100	22,200	33,900	37,900	42,800	21,100	25,200	36,900	40,900	45,800	60,400	65,300	70,200
~180		21,000	25,100	39,200	43,100	48,200	24,000	28,100	42,200	46,100	51,200	68,100	73,100	78,100
~220		23,200	27,300	42,400	46,400	51,700	26,200	30,300	45,400	49,400	54,700	72,700	77,800	82,900
~260		26,100	30,300	47,700	51,600	57,200	29,100	33,300	50,700	54,600	60,200	80,300	85,800	90,800
~300		28,600	32,900	52,600	56,500	62,300	31,600	35,900	55,600	59,500	65,300	87,800	93,200	98,500

※ドラム式: 仕上り巾39cm以下の場合、仕上り丈は200cmまでとなります。

		コード式	
H	W	18~30	20,000
50~100		18~30	20,000
~140		23,100	
~180		26,000	
~220		28,600	
~240		30,400	

		コード式				ドラム式								
H	W	30~45	~90	~140	~190	~240	30~45	~90	~140	~190	~240	~290	~340	~390
50~100		18,300	24,600	36,400	43,000	49,400	21,300	27,600	39,400	46,000	52,400	65,800	72,300	78,900
~140		21,100	27,800	42,300	49,300	56,300	24,100	30,800	45,300	52,300	59,300	75,200	82,100	88,900
~180		24,300	31,500	48,500	56,100	63,600	27,300	34,500	51,500	59,100	66,600	85,000	92,500	99,800
~220		26,700	34,200	52,600	60,600	68,800	29,700	37,200	55,600	63,600	71,800	91,400	99,100	106,700
~260		30,000	38,100	59,300	67,900	76,800	33,000	41,100	62,300	70,900	79,800	102,100	110,200	118,400
~300		32,900	41,600	65,500	74,800	84,300	35,900	44,600	68,500	77,800	87,300	112,300	120,900	129,600

※ドラム式: 仕上り巾39cm以下の場合、仕上り丈は200cmまでとなります。

		(片開き/タッセルなし)					
H	W	~72	~100	~127	~155	~183	
~100		16,000	25,600	29,800	31,900	41,000	
~140		18,500	30,200	34,400	36,500	48,600	
~180		19,500	32,600	36,800	38,900	52,100	
~220		22,000	37,700	41,900	44,000	59,700	
~260		24,500	42,700	46,900	49,000	66,700	
~300		25,500	44,700	48,900	51,000	70,200	
26mm		-2,800	-2,100	-4,900	-4,200	-4,900	
18mm		-4,900	-5,600	-9,100	-9,800	-10,500	

※生地を伸ばした状態のサイズでご発注ください。

		スプリング・チェーンタイプ				
H	W	30~60	~80	~100	~120	~138
50~80		30,800	33,300	35,300	36,500	38,200
~120		33,500	36,600	38,600	39,700	41,600
~160		36,500	40,300	42,300	43,500	44,800
~200		39,800	42,800	45,000	46,200	47,500
~240			46,400	48,700	49,900	51,300

※丈は巾の3倍までが限度です。
 ※ロールソフト加工品は非防炎品になります。

		ストレートバランス				
H	W	~100	~150	~200	~250	~300
~40		11,900	19,000	23,400	27,800	34,900

※マジックテープ仕様・裏面スポンジ付の価格になります。

		三ツ山・箱ヒダバランス (約2.5倍ヒダ)				
H	W	~100	~150	~200	~250	~300
~40		9,900	14,100	18,700	23,900	25,400

※マジックテープ仕様の価格になります。

遮光

TM-54230~54233



巾 ◇ 150cm 価格 ◇ 5,800円/m
組成 ◇ ポリエステル100%

リポート ◇ タテ 17.0cm ヨコ - cm
寸法変化率 ◇ 水洗い/タテ 0.0% ヨコ 0.0%
ドライ/タテ 0.0% ヨコ 0.0%

取扱い表示 ◇ リ-30 30 40 50 60 70 80 90 100
防炎性能 ◇ (イ) あて布使用
Made in Japan

H	W	~67 1巾(片開き)	~150 2巾	~225 3巾	~300 4巾	~375 5巾	~450 6巾	~525 7巾
~100		14,400	28,100	39,900	52,500	64,500	76,200	88,900
~120		15,300	30,400	43,900	57,300	70,800	84,100	97,600
~140		16,900	33,600	48,700	62,900	77,800	92,900	107,100
~160		18,500	36,000	52,500	68,300	84,100	100,800	116,600
~180		20,000	39,200	56,600	73,900	91,300	108,700	126,100
~200		22,300	43,900	64,500	84,100	104,700	124,500	145,000
~220		23,900	47,100	68,300	89,700	111,000	133,100	154,500
~240		24,800	49,400	72,400	95,200	118,200	141,000	164,000
~260		26,400	52,500	76,200	100,800	124,500	148,900	173,500
~280		27,900	55,000	80,300	106,300	131,500	156,800	183,000
約1.5倍ヒダ		~88	~200	~300	~400	~500		

※片開きはW270cmまで

H	W	~67 1巾(片開き)	~150 2巾	~225 3巾	~300 4巾	~375 5巾	~450 6巾	~525 7巾
~100		14,900	29,100	41,300	54,400	66,800	79,000	92,100
~120		15,800	31,400	45,500	59,300	73,300	87,200	101,200
~140		17,500	34,700	50,400	65,100	80,600	96,300	111,100
~160		19,100	37,300	54,400	70,800	87,200	104,500	120,900
~180		20,700	40,500	58,600	76,600	94,700	112,700	130,700
~200		23,100	45,500	66,800	87,200	108,500	129,100	150,400
~220		24,800	48,700	70,800	93,000	115,100	138,000	160,300
~240		25,700	51,100	75,000	98,700	122,500	146,200	170,100
~260		27,300	54,400	79,000	104,500	129,100	154,400	179,900
~280		28,900	56,900	83,200	110,200	136,400	162,600	189,800
約1.5倍ヒダ		~88	~200	~300	~400	~500		

※片開きはW270cmまで

H	W	~67 1巾(片開き)	~150 2巾	~225 3巾	~300 4巾	~375 5巾	~450 6巾	~525 7巾	~600 8巾
~100		14,000	27,200	38,500	50,700	62,100	73,500	85,600	97,100
~120		14,800	29,400	42,400	55,200	68,200	81,100	94,100	106,900
~140		16,300	32,400	46,900	60,600	75,000	89,500	103,200	117,600
~160		17,800	34,800	50,700	65,900	81,100	97,100	112,300	128,200
~180		19,300	37,800	54,500	71,300	88,000	104,700	121,400	138,100
~200		21,600	42,400	62,100	81,100	100,800	119,900	139,700	158,600
~220		23,100	45,400	65,900	86,500	106,900	128,200	148,800	169,200
~240		23,900	47,600	69,700	91,700	113,800	135,800	157,900	179,900
~260		25,400	50,700	73,500	97,100	119,900	143,400	167,000	189,800
~280		26,900	53,000	77,300	102,400	126,700	151,000	176,100	200,500
約1.5倍ヒダ		~88	~200	~300	~400	~500	~600	~700	~800
フラット前ヒダ		~130	~260	~410	~560				

H	W	~67 1巾(片開き)	~150 2巾	~225 3巾	~300 4巾	~375 5巾	~450 6巾	~525 7巾	~600 8巾
~100		15,900	30,900	44,000	58,100	71,400	84,500	98,600	111,900
~120		16,900	33,500	48,500	63,400	78,500	93,300	108,400	123,200
~140		18,600	37,000	53,800	69,700	86,300	103,100	118,900	135,600
~160		20,400	39,700	58,100	75,700	93,300	111,900	129,500	147,900
~180		22,100	43,300	62,600	82,000	101,300	120,700	140,100	159,400
~200		24,700	48,500	71,400	93,300	116,200	138,300	161,200	183,100
~220		26,400	52,100	75,700	99,600	123,200	147,900	171,700	195,400
~240		27,400	54,600	80,200	105,600	131,300	156,700	182,300	207,700
~260		29,200	58,100	84,500	111,900	138,300	165,500	192,900	219,300

※片開きはW300cmまで

		コード式				ドラム式								
H	W	30~45	~90	~140	~190	~240	30~45	~90	~140	~190	~240	~290	~340	~390
50~100		16,200	20,200	24,700	34,600	39,300	19,200	23,200	27,700	37,600	42,300	49,600	60,400	65,200
~140		19,600	23,600	28,400	40,700	45,700	22,600	26,600	31,400	43,700	48,700	56,300	69,700	74,600
~180		22,500	26,500	31,500	45,400	50,500	25,500	29,500	34,500	48,400	53,500	61,300	76,800	81,800
~220		25,900	30,000	35,200	51,500	56,800	28,900	33,000	38,200	54,500	59,800	68,000	86,100	91,200
~260		28,200	32,400	37,800	56,100	61,600	31,200	35,400	40,800	59,100	64,600	73,000	92,900	97,900
~300		31,100	35,300	41,000	60,800	66,500	34,100	38,300	44,000	63,800	69,500	78,200	99,500	104,800

※ドラム式：仕上り巾39cm以下の場合、仕上り丈は200cmまでとなります。

		コード式	
H	W	18~30	
50~100		18~30	20,600
~140			24,400
~180			27,300
~220			31,100
~240			33,000

		コード式				ドラム式								
H	W	30~45	~90	~140	~190	~240	30~45	~90	~140	~190	~240	~290	~340	~390
50~100		19,000	25,300	31,900	44,800	51,100	22,000	28,300	34,900	47,800	54,100	62,300	75,100	81,700
~140		22,700	29,400	36,400	52,400	59,300	25,700	32,400	39,400	55,400	62,300	70,900	86,700	93,500
~180		25,800	32,900	40,400	58,500	66,000	28,800	35,900	43,400	61,500	69,000	77,900	96,400	103,700
~220		29,400	37,000	45,000	66,100	74,200	32,400	40,000	48,000	69,100	77,200	86,500	107,700	115,400
~260		32,100	40,300	48,900	72,700	81,600	35,100	43,300	51,900	75,700	84,600	94,300	117,600	125,800
~300		35,400	44,100	53,400	79,300	88,900	38,400	47,100	56,400	82,300	91,900	102,100	127,500	136,100

※ドラム式：仕上り巾39cm以下の場合、仕上り丈は200cmまでとなります。

		38mm (片開き/タッセルなし)					
H	W	~72	~100	~127	~155	~183	
~100		17,800	28,700	32,900	35,000	45,800	
~140		19,600	32,700	36,900	39,000	52,300	
~180		21,900	36,900	41,100	43,200	58,100	
~220		24,800	42,700	46,900	49,000	66,800	
~260		26,600	46,800	51,000	53,100	72,700	
~300		28,300	50,300	54,500	56,600	78,500	
26mm		-2,800	-2,100	-4,900	-4,200	-4,900	
18mm		-4,900	-5,600	-9,100	-9,800	-10,500	

※生地を伸ばした状態のサイズでご発注ください。

		スプリング・チェーンタイプ				
H	W	30~60	~80	~100	~120	~140
50~80		31,400	33,900	35,900	37,100	38,800
~120		34,800	37,900	39,900	41,000	42,900
~160		37,800	41,600	43,600	44,800	46,100
~200		42,300	45,300	47,500	48,700	50,000
~240			48,300	50,600	51,800	53,200

※丈は巾の3倍までが限度です。
※ロールソフト加工品は非防災品になります。

		ストレートバランス				
H	W	~100	~150	~200	~250	~300
~40		12,100	19,700	24,100	28,500	36,200

※マジックテープ仕様・裏面スポンジ付の価格になります。

H	W	~100	~150	~200	~250	~300
~40		12,000	17,700	22,900	29,600	31,100

※マジックテープ仕様の価格になります。

遮光

TM-54234・54235

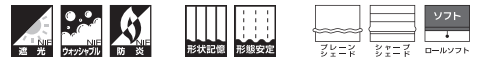

巾 ◇ 150cm 価格 ◇ 6,000円/m リポート ◇ タテ 30.0cm ヨコ 15.0cm 取扱い表示 ◇ リ-30 40 炎 1 2 3 4 5 6 7 8 9 10 11 12 13 14 15 16 17 18 19 20 21 22 23 24 25 26 27 28 29 30 31 32 33 34 35 36 37 38 39 40 41 42 43 44 45 46 47 48 49 50 51 52 53 54 55 56 57 58 59 60 61 62 63 64 65 66 67 68 69 70 71 72 73 74 75 76 77 78 79 80 81 82 83 84 85 86 87 88 89 90 91 92 93 94 95 96 97 98 99 100
 組成 ◇ ポリエステル100% 寸法変化率 ◇ 水洗い/タテ 0.0% ヨコ 0.0% 防炎性能 ◇ (イ) 乾燥/タテ 0.3% ヨコ 0.3% Made in Japan

H	W	~67 1巾(片開き)	~150 2巾	~225 3巾	~300 4巾	~375 5巾	~450 6巾	~525 7巾
~100		14,100	27,900	40,200	52,200	64,500	76,500	88,800
~120		16,400	32,800	47,400	62,000	76,500	91,100	105,700
~140		16,400	32,800	47,400	62,000	76,500	91,100	105,700
~160		18,900	37,700	54,700	71,700	88,800	105,700	122,800
~180		21,300	42,500	62,000	81,400	100,800	120,300	139,700
~200		21,300	42,500	62,000	81,400	100,800	120,300	139,700
~220		23,800	47,400	69,300	91,100	113,100	134,900	156,800
~240		26,100	52,200	76,500	100,800	125,100	149,400	173,700
~260		26,100	52,200	76,500	100,800	125,100	149,400	173,700
~280		28,600	57,100	83,900	110,600	137,400	164,000	190,800
約1.5倍ヒダ		~88	~200	~300	~400	~500		

※片開きはW270cmまで

H	W	~67 1巾(片開き)	~150 2巾	~225 3巾	~300 4巾	~375 5巾	~450 6巾	~525 7巾
~100		14,500	28,800	41,500	54,000	66,700	79,200	91,900
~120		17,000	33,900	49,000	64,100	79,200	94,400	109,500
~140		17,000	33,900	49,000	64,100	79,200	94,400	109,500
~160		19,600	38,900	56,600	74,200	91,900	109,500	127,200
~180		22,000	44,000	64,100	84,300	104,400	124,600	144,800
~200		22,000	44,000	64,100	84,300	104,400	124,600	144,800
~220		24,600	49,000	71,800	94,400	117,100	139,700	162,500
~240		27,000	54,000	79,200	104,400	129,600	154,800	180,000
~260		27,000	54,000	79,200	104,400	129,600	154,800	180,000
~280		29,600	59,100	86,900	114,500	142,300	170,000	197,800
約1.5倍ヒダ		~88	~200	~300	~400	~500		

※片開きはW270cmまで

H	W	~67 1巾(片開き)	~150 2巾	~225 3巾	~300 4巾	~375 5巾	~450 6巾	~525 7巾	~600 8巾
~100		13,600	27,000	38,800	50,400	62,200	73,800	85,600	97,200
~120		15,900	31,700	45,800	59,800	73,800	87,900	101,900	116,000
~140		15,900	31,700	45,800	59,800	73,800	87,900	101,900	116,000
~160		18,300	36,400	52,800	69,200	85,600	101,900	118,400	134,700
~180		20,600	41,100	59,800	78,500	97,200	116,000	134,700	153,400
~200		20,600	41,100	59,800	78,500	97,200	116,000	134,700	153,400
~220		23,000	45,800	66,900	87,900	109,000	130,000	151,100	172,100
~240		25,200	50,400	73,800	97,200	120,600	144,000	167,400	190,800
~260		25,200	50,400	73,800	97,200	120,600	144,000	167,400	190,800
~280		27,600	55,100	80,900	106,600	132,400	158,100	183,900	209,600
約1.5倍ヒダ		~88	~200	~300	~400	~500	~600	~700	~800
フラット前1倍ヒダ		~130	~260	~410	~560				

H	W	~67 1巾(片開き)	~150 2巾	~225 3巾	~300 4巾	~375 5巾	~450 6巾	~525 7巾	~600 8巾
~100		15,400	30,600	44,200	57,600	71,200	84,600	98,200	111,600
~120		18,000	36,000	52,200	68,400	84,600	100,800	117,000	133,200
~140		18,000	36,000	52,200	68,400	84,600	100,800	117,000	133,200
~160		20,800	41,400	60,400	79,200	98,200	117,000	136,000	154,800
~180		23,400	46,800	68,400	90,000	111,600	133,200	154,800	176,400
~200		23,400	46,800	68,400	90,000	111,600	133,200	154,800	176,400
~220		26,200	52,200	76,600	100,800	125,200	149,400	173,800	198,000
~240		28,800	57,600	84,600	111,600	138,600	165,600	192,600	219,600
~260		28,800	57,600	84,600	111,600	138,600	165,600	192,600	219,600

※片開きはW300cmまで

H	W	コード式				ドラム式								
		30~45	~90	~140	~240	30~45	~90	~140	~190	~240	~290	~340	~390	
50~100		16,400	20,400	24,900	35,000	39,700	19,400	23,400	27,900	38,000	42,700	50,000	61,000	65,800
~140		20,400	24,400	29,200	42,300	47,200	23,400	27,400	32,200	45,300	50,200	57,900	72,100	77,000
~180		22,800	26,900	31,900	46,500	51,700	25,800	29,900	34,900	49,500	54,700	62,500	78,400	83,400
~220		25,300	29,400	34,600	50,800	56,200	28,300	32,400	37,600	53,800	59,200	67,300	84,800	89,900
~260		29,300	33,400	38,800	58,100	63,600	32,300	36,400	41,800	61,100	66,600	75,000	95,900	100,900
~300		31,700	35,900	41,500	62,300	68,100	34,700	38,900	44,500	65,300	71,100	79,800	102,200	107,500

※ドラム式：仕上り巾39cm以下の場合、仕上り丈は200cmまでとなります。

H	W	コード式
50~100		18~30
~140		20,800
~180		25,200
~220		27,600
~260		30,600
~300		33,000

H	W	コード式				ドラム式								
		30~45	~90	~140	~240	30~45	~90	~140	~190	~240	~290	~340	~390	
50~100		19,200	25,500	32,100	45,200	51,500	22,200	28,500	35,100	48,200	54,500	62,700	75,800	82,300
~140		23,500	30,200	37,300	54,100	61,000	26,500	33,200	40,300	57,100	64,000	72,600	89,200	96,100
~180		26,100	33,300	40,800	59,700	67,300	29,100	36,300	43,800	62,700	70,300	79,200	98,100	105,300
~220		28,800	36,400	44,400	65,400	73,500	31,800	39,400	47,400	68,400	76,500	85,800	106,400	114,100
~260		33,200	41,400	50,000	74,800	83,700	36,200	44,400	53,000	77,800	86,700	96,400	120,800	128,900
~300		36,000	44,700	54,000	81,000	90,600	39,000	47,700	57,000	84,000	93,600	103,900	130,300	139,000

※ドラム式：仕上り巾39cm以下の場合、仕上り丈は200cmまでとなります。

H	W	38mm	片開き/タッセルなし			
~100		~72	~100	~127	~155	~183
~140		17,500	28,500	32,700	34,800	46,000
~180		19,200	32,100	36,300	38,400	51,300
~220		22,800	39,300	43,500	45,600	62,100
~260		24,700	42,900	47,100	49,200	67,600
~300		26,400	46,500	50,700	52,800	72,900
~340		30,000	53,700	57,900	60,000	83,700
26mm		-2,800	-2,100	-4,900	-4,200	-4,900
18mm		-4,900	-5,600	-9,100	-9,800	-10,500

※生地を伸ばした状態のサイズでご発注ください。

H	W	スプリング・チェーンタイプ				
		30~60	~80	~100	~120	~140
50~80		31,600	34,100	36,100	37,300	39,000
~120		35,600	38,700	40,700	41,800	43,700
~160		38,100	41,900	43,900	45,100	46,400
~200		41,800	44,800	47,000	48,200	49,500
~240			49,200	51,500	52,700	54,100

※丈は巾の3倍までが限度です。
※ロールソフト加工品は非防炎品になります。

ストレートバランス						
H	W	~100	~150	~200	~250	~300
~40		11,700	19,000	23,400	27,800	35,100

※マジックテープ仕様・裏面スポンジ付の価格になります。

H	W	~100	~150	~200	~250	~300
~40		12,800	18,600	24,400	31,200	32,700

※マジックテープ仕様・裏面スポンジ付の価格になります。

プレーン		パイピング		
サイズ	価格	サイズ	価格	
40x40	7,000	40x40	8,000	
45x45	8,400	45x45	9,400	
フリル付				
サイズ	40x40	45x45	40x40	45x45
	11,800	13,700	11,300	13,200

※中材込みの価格になります。

TM-54236~54238



巾 ◇ 150cm 価格 ◇ 4,650円/m
組成 ◇ ポリエステル100%

リポート ◇ タテ6.5cm ヨコ13.6cm
寸法変化率 ◇ 水洗い/タテ -0.4% ヨコ -0.1%
ドライ/タテ -0.7% ヨコ -0.2%

取扱い表示 ◇ リ-30 40 30 30 30 30 30 30 30 30
防炎性能 ◇ (イ) あて布使用
Made in Japan

H	W	~67 1巾(片開き)	~150 2巾	~225 3巾	~300 4巾	~375 5巾	~450 6巾	~525 7巾
~100		11,800	22,800	32,200	42,300	51,700	61,200	71,400
~120		13,100	25,500	36,300	47,100	58,500	69,300	80,100
~140		14,500	28,200	40,300	52,500	64,600	77,400	89,500
~160		15,800	30,900	44,400	57,900	71,400	84,900	98,400
~180		17,200	33,600	48,400	63,300	78,100	93,000	107,800
~200		17,800	36,300	52,500	68,700	84,900	101,100	117,300
~220		19,100	38,200	55,800	73,300	90,900	108,400	126,000
~240		20,500	40,900	59,800	78,700	97,600	116,500	135,400
~260		22,600	45,000	65,200	86,200	106,500	127,300	147,600
~280		23,900	47,100	69,300	90,900	113,200	134,800	157,000
約1.5倍ヒダ		~88	~200	~300	~400	~500		

※片開きはW270cmまで

H	W	~67 1巾(片開き)	~150 2巾	~225 3巾	~300 4巾	~375 5巾	~450 6巾	~525 7巾
~100		12,200	23,600	33,500	44,000	53,900	63,700	74,400
~120		13,600	26,500	37,700	49,000	60,900	72,200	83,500
~140		15,100	29,300	42,000	54,700	67,300	80,700	93,300
~160		16,500	32,100	46,200	60,300	74,400	88,500	102,600
~180		17,900	34,900	50,400	65,900	81,400	97,000	112,500
~200		18,500	37,700	54,700	71,600	88,500	105,400	122,300
~220		19,900	39,800	58,100	76,400	94,800	113,100	131,400
~240		21,300	42,600	62,300	82,100	101,800	121,500	141,300
~260		23,500	46,800	68,000	89,900	111,100	132,800	154,000
~280		24,900	49,000	72,200	94,800	118,100	140,700	163,800
約1.5倍ヒダ		~88	~200	~300	~400	~500		

※片開きはW270cmまで

H	W	~67 1巾(片開き)	~150 2巾	~225 3巾	~300 4巾	~375 5巾	~450 6巾	~525 7巾	~600 8巾
~100		11,300	21,900	30,900	40,500	49,500	58,600	68,300	77,300
~120		12,600	24,500	34,800	45,100	56,000	66,300	76,600	87,000
~140		13,900	27,000	38,600	50,300	61,900	74,100	85,700	97,300
~160		15,200	29,600	42,500	55,400	68,300	81,200	94,100	107,600
~180		16,500	32,200	46,400	60,600	74,800	89,000	103,100	117,300
~200		17,100	34,800	50,300	65,700	81,200	96,700	112,200	127,700
~220		18,300	36,600	53,400	70,200	87,000	103,700	120,500	137,300
~240		19,600	39,200	57,300	75,300	93,400	111,500	129,500	147,600
~260		21,600	43,100	62,400	82,500	101,900	121,800	141,100	161,200
~280		22,900	45,100	66,300	87,000	108,300	128,900	150,200	170,800
約1.5倍ヒダ		~88	~200	~300	~400	~500	~600	~700	~800
フラット前ヒダ		~130	~260	~410	~560				

H	W	~67 1巾(片開き)	~150 2巾	~225 3巾	~300 4巾	~375 5巾	~450 6巾	~525 7巾	~600 8巾
~100		13,200	25,400	36,100	47,500	58,200	68,900	80,500	91,200
~120		14,700	28,500	40,700	52,900	65,800	78,100	90,300	102,600
~140		16,200	31,500	45,300	59,100	72,800	87,300	101,000	114,800
~160		17,700	34,600	49,900	65,200	80,500	95,800	111,100	127,000
~180		19,300	37,600	54,500	71,300	88,100	105,000	121,800	138,600
~200		19,900	40,700	59,100	77,400	95,800	114,100	132,500	150,900
~220		21,500	42,900	62,800	82,700	102,600	122,400	142,300	162,200
~240		23,000	45,900	67,400	88,800	110,200	131,600	153,000	174,500
~260		25,400	50,500	73,500	97,300	120,300	143,900	166,800	190,600

※片開きはW300cmまで

H	W	コード式				ドラム式								
		30~45	~90	~140	~240	30~45	~90	~140	~190	~240	~290	~340	~390	
50~100		15,400	19,400	23,900	32,700	37,400	18,400	22,400	26,900	35,700	40,400	47,600	57,200	62,000
~140		17,900	21,900	26,700	37,000	42,000	20,900	24,900	29,700	40,000	45,000	52,600	63,900	68,800
~180		20,300	24,400	29,400	41,400	46,500	23,300	27,400	32,400	44,400	49,500	57,200	70,300	75,300
~220		22,400	26,600	31,800	45,800	51,100	25,400	29,600	34,800	48,800	54,100	62,100	76,800	82,000
~260		24,900	29,100	34,500	49,700	55,200	27,900	32,100	37,500	52,700	58,200	66,400	83,100	88,100
~300		27,800	32,100	37,700	54,500	60,300	30,800	35,100	40,700	57,500	63,300	71,700	90,300	95,600

※ドラム式：仕上り巾39cm以下の場合、仕上り丈は200cmまでとなります。

H	W	コード式
50~100		18~30
~140		19,900
~180		22,900
~220		25,400
~240		28,000
~240		29,700

H	W	スプリング・チェーンタイプ				
		30~60	~80	~100	~120	~140
50~80		30,700	33,200	35,200	36,400	38,100
~120		33,300	36,400	38,400	39,500	41,400
~160		35,900	39,700	41,700	42,900	44,200
~200		39,200	42,200	44,400	45,600	46,900
~240		45,300	47,600	48,800	50,200	

※丈は巾の3倍までが限度です。
※ロールソフト加工品は非防炎品になります。

H	W	38mm	約72	~100	~127	~155	~183
~100		15,900	24,900	29,100	31,200	40,100	
~140		17,800	28,800	33,000	35,100	46,000	
~180		19,800	32,700	36,900	39,000	52,000	
~220		21,200	36,100	40,300	42,400	57,300	
~260		23,700	41,100	45,300	47,400	64,200	
~300		25,700	44,500	48,700	50,800	70,100	
26mm		-2,800	-2,100	-4,900	-4,200	-4,900	
18mm		-4,900	-5,600	-9,100	-9,800	-10,500	

※生地を伸ばした状態のサイズでご発注ください。

H	W	ストレートバランス				
~100		~100	~150	~200	~250	~300
~40		11,500	18,100	22,500	26,900	33,900

※マジックテープ仕様・裏面スポンジ付の価格になります。

H	W	~100	~150	~200	~250	~300
~40		9,700	13,800	17,900	23,000	24,500

※マジックテープ仕様の価格になります。

遮光

TM-54239~54242



巾 ◇ 148 cm 価格 ◇ 4,400 円/m リポート ◇ タテ cm ヨコ 3.8 cm 取扱い表示 ◇ リ-30 40 炎 1 2 3 4 5 6 7 8 9 10 11 12 13 14 15 16 17 18 19 20 21 22 23 24 25 26 27 28 29 30 31 32 33 34 35 36 37 38 39 40 41 42 43 44 45 46 47 48 49 50 51 52 53 54 55 56 57 58 59 60 61 62 63 64 65 66 67 68 69 70 71 72 73 74 75 76 77 78 79 80 81 82 83 84 85 86 87 88 89 90 91 92 93 94 95 96 97 98 99 100
 組成 ◇ ポリエステル100% 寸法変化率 ◇ 水洗い/タテ 0.0% ヨコ -0.5% 防炎性能 ◇ (イ) 乾燥/タテ -0.5% ヨコ -0.5% Made in Japan

H	W	~65 1巾(片開き)	~148 2巾	~222 3巾	~296 4巾	~370 5巾	~444 6巾	~518 7巾
~100		10,600	21,100	30,200	39,300	48,400	57,300	66,400
~120		11,900	23,700	34,100	44,500	54,700	65,100	75,500
~140		13,200	26,300	38,000	49,700	61,200	72,900	84,500
~160		14,500	28,900	41,900	54,700	67,700	80,700	93,600
~180		15,800	31,500	45,800	59,900	74,200	88,400	102,700
~200		17,100	34,100	49,700	65,100	80,700	96,200	111,800
~220		18,300	36,700	53,400	70,300	87,100	104,000	120,700
~240		19,600	39,300	57,300	75,500	93,600	111,800	129,800
~260		20,900	41,900	61,200	80,700	100,100	119,400	138,900
~280		22,200	44,500	65,100	85,800	106,600	127,200	148,000
約1.5倍ヒダ		~86	~192	~296	~394	~493		

※片開きはW270cmまで

H	W	~65 1巾(片開き)	~148 2巾	~222 3巾	~296 4巾	~370 5巾	~444 6巾	~518 7巾
~100		11,000	21,900	31,400	40,900	50,400	59,800	69,300
~120		12,400	24,600	35,500	46,400	57,100	68,000	78,800
~140		13,800	27,300	39,600	51,800	63,900	76,100	88,200
~160		15,100	30,000	43,600	57,100	70,700	84,300	97,700
~180		16,500	32,800	47,700	62,500	77,500	92,300	107,200
~200		17,800	35,500	51,800	68,000	84,300	100,400	116,800
~220		19,000	38,200	55,700	73,400	90,900	108,600	126,100
~240		20,400	40,900	59,800	78,800	97,700	116,800	135,600
~260		21,800	43,600	63,900	84,300	104,500	124,800	145,200
~280		23,100	46,400	68,000	89,600	111,300	132,900	154,700
約1.5倍ヒダ		~86	~192	~296	~394	~493		

※片開きはW270cmまで

H	W	~65 1巾(片開き)	~148 2巾	~222 3巾	~296 4巾	~370 5巾	~444 6巾	~518 7巾	~592 8巾
~100		10,200	20,200	28,900	37,600	46,300	54,800	63,500	72,200
~120		11,400	22,700	32,600	42,600	52,400	62,300	72,200	82,000
~140		12,700	25,200	36,400	47,500	58,600	69,700	80,800	91,900
~160		13,900	27,700	40,100	52,400	64,800	77,200	89,400	101,800
~180		15,200	30,200	43,800	57,300	71,000	84,500	98,100	111,600
~200		16,400	32,600	47,500	62,300	77,200	91,900	106,800	121,600
~220		17,500	35,100	51,100	67,200	83,200	99,400	115,400	131,500
~240		18,800	37,600	54,800	72,200	89,400	106,800	124,000	141,400
~260		20,000	40,100	58,600	77,200	95,600	114,100	132,700	151,200
~280		21,200	42,600	62,300	82,000	101,800	121,600	141,400	161,100
約1.5倍ヒダ		~86	~192	~296	~394	~493	~592	~690	~789
フラット前1倍ヒダ		~128	~256	~404	~552				

H	W	~65 1巾(片開き)	~148 2巾	~222 3巾	~296 4巾	~370 5巾	~444 6巾	~518 7巾	~592 8巾
~100		11,900	23,500	33,900	44,200	54,600	64,800	75,100	85,500
~120		13,400	26,500	38,300	50,200	61,800	73,600	85,500	97,100
~140		14,800	29,400	42,800	56,100	69,200	82,500	95,600	109,000
~160		16,300	32,400	47,200	61,800	76,600	91,400	106,000	120,800
~180		17,800	35,400	51,600	67,700	84,000	100,100	116,400	132,400
~200		19,300	38,300	56,100	73,600	91,400	109,000	126,700	144,300
~220		20,600	41,300	60,300	79,600	98,600	117,800	136,900	156,100
~240		22,000	44,200	64,800	85,500	106,000	126,700	147,200	168,000
~260		23,500	47,200	69,200	91,400	113,400	135,400	157,600	179,600

※片開きはW300cmまで

		コード式				ドラム式								
H	W	30~45	~90	~140	~190	30~45	~90	~140	~190	~240	~290	~340	~390	
50~100		14,700	18,700	27,800	31,800	36,500	17,700	21,700	30,800	34,800	39,500	51,300	56,100	60,800
~140		17,100	21,200	32,000	36,000	40,900	20,100	24,200	35,000	39,000	43,900	57,500	62,400	67,300
~180		19,500	23,600	36,200	40,200	45,300	22,500	26,600	39,200	43,200	48,300	63,600	68,600	73,600
~220		21,900	26,100	40,400	44,400	49,700	24,900	29,100	43,400	47,400	52,700	69,800	74,900	80,000
~260		24,300	28,500	44,500	48,500	54,100	27,300	31,500	47,500	51,500	57,100	75,800	81,300	86,300
~300		26,700	31,000	48,700	52,700	58,500	29,700	34,000	51,700	55,700	61,500	82,100	87,400	92,800

※ドラム式: 仕上り巾39cm以下の場合、仕上り丈は200cmまでとなります。

		コード式	
H	W	18~30	
50~100		18,300	
~140		22,200	
~180		24,600	
~220		27,500	
~240		29,200	

		コード式				ドラム式								
H	W	30~45	~90	~140	~190	30~45	~90	~140	~190	~240	~290	~340	~390	
50~100		17,500	23,800	35,100	41,700	48,100	20,500	26,800	38,100	44,700	51,100	64,000	70,600	77,200
~140		20,100	26,800	40,200	47,300	54,300	23,100	29,800	43,200	50,300	57,300	72,100	79,100	85,900
~180		22,700	29,900	45,300	52,900	60,400	25,700	32,900	48,300	55,900	63,400	80,300	87,800	95,100
~220		25,400	32,900	50,400	58,500	66,600	28,400	35,900	53,400	61,500	69,600	88,400	96,000	103,700
~260		28,100	36,200	56,000	64,600	73,500	31,100	39,200	59,000	67,600	76,500	97,300	105,500	113,600
~300		30,900	39,600	61,500	70,700	80,300	33,900	42,600	64,500	73,700	83,300	106,200	114,900	123,500

※ドラム式: 仕上り巾39cm以下の場合、仕上り丈は200cmまでとなります。

		(片開き/タッセルなし)					
H	W	~72	~100	~127	~155	~183	
~100		15,100	23,700	27,900	30,000	38,700	
~140		16,900	27,500	31,700	33,800	44,400	
~180		18,800	31,200	35,400	37,500	50,000	
~220		20,600	35,000	39,200	41,300	55,600	
~260		22,500	38,800	43,000	45,100	61,300	
~300		24,400	42,600	46,800	48,900	66,900	
26mm		-2,800	-2,100	-4,900	-4,200	-4,900	
18mm		-4,900	-5,600	-9,100	-9,800	-10,500	

※生地を伸ばした状態のサイズでご発注ください。

		スプリング・チェーンタイプ				
H	W	30~60	~80	~100	~120	~138
50~80		30,100	32,600	34,600	35,800	37,500
~120		32,600	35,700	37,700	38,800	40,700
~160		35,100	38,900	40,900	42,100	43,400
~200		38,700	41,700	43,900	45,100	46,400
~240			44,700	47,000	48,200	49,600

※丈は巾の3倍までが限度です。
 ※ロールソフト加工品は非防炎品になります。

		ストレートバランス				
H	W	~100	~150	~200	~250	~300
~40		11,000	17,500	21,900	26,300	32,800

※マジックテープ仕様・裏面スポンジ付の価格になります。

		三ツ山・箱ヒダバランス (約2.5倍ヒダ)				
H	W	~100	~150	~200	~250	~300
~40		9,100	13,000	17,000	22,000	23,500

※マジックテープ仕様の価格になります。

プレーン		パイピング	
サイズ	価格	サイズ	価格
40x40	6,400	40x40	7,300
45x45	7,800	45x45	8,700
フリル付		フレーム付	
サイズ	価格	サイズ	価格
40x40	10,300	40x40	9,900
45x45	12,000	45x45	11,700

※中材込みの価格になります。

TM-54243~54245



巾 ◇ 150cm 価格 ◇ 4,300円/m
組成 ◇ ポリエステル100%

リポート ◇ タテ cm ヨコ cm
寸法変化率 ◇ 水洗い/タテ 0.0% ヨコ 0.0%
ドライ/タテ -1.0% ヨコ -0.5%

取扱い表示 ◇ リ-30 40 30 30 30 30 30
防炎性能 ◇ (イ) あて布使用
Made in Japan

H	W	~67 1巾(片開き)	~150 2巾	~225 3巾	~300 4巾	~375 5巾	~450 6巾	~525 7巾
~100		10,500	20,900	29,800	38,800	47,800	56,700	65,700
~120		11,700	23,400	33,700	43,900	54,200	64,400	74,600
~140		13,000	26,000	37,500	49,000	60,600	72,100	83,600
~160		14,300	28,600	41,400	54,200	67,000	79,800	92,600
~180		15,600	31,100	45,200	59,300	73,400	87,400	101,500
~200		16,900	33,700	49,000	64,400	79,800	95,100	110,500
~220		18,100	36,200	52,900	69,500	86,200	102,800	119,400
~240		19,400	38,800	56,700	74,600	92,600	110,500	128,400
~260		20,700	41,400	60,600	79,800	99,000	118,200	137,400
~280		22,000	43,900	64,400	84,900	105,400	125,800	146,300
約1.5倍ヒダ		~88	~200	~300	~400	~500		

※片開きはW270cmまで

H	W	~67 1巾(片開き)	~150 2巾	~225 3巾	~300 4巾	~375 5巾	~450 6巾	~525 7巾
~100		10,900	21,700	31,100	40,500	49,900	59,200	68,600
~120		12,200	24,400	35,100	45,800	56,600	67,300	78,000
~140		13,600	27,100	39,100	51,200	63,300	75,300	87,400
~160		14,900	29,800	43,200	56,600	70,000	83,400	96,800
~180		16,200	32,400	47,200	61,900	76,700	91,400	106,100
~200		17,600	35,100	51,200	67,300	83,400	99,400	115,500
~220		18,900	37,800	55,200	72,600	90,100	107,500	124,900
~240		20,300	40,500	59,200	78,000	96,800	115,500	134,300
~260		21,600	43,200	63,300	83,400	103,500	123,600	143,700
~280		22,900	45,800	67,300	88,700	110,200	131,600	153,000
約1.5倍ヒダ		~88	~200	~300	~400	~500		

※片開きはW270cmまで

H	W	~67 1巾(片開き)	~150 2巾	~225 3巾	~300 4巾	~375 5巾	~450 6巾	~525 7巾	~600 8巾
~100		10,000	20,000	28,600	37,100	45,700	54,200	62,700	71,300
~120		11,300	22,500	32,200	42,000	51,800	61,500	71,300	81,000
~140		12,500	24,900	35,900	46,900	57,900	68,800	79,800	90,800
~160		13,700	27,400	39,600	51,800	64,000	76,200	88,400	100,600
~180		14,900	29,800	43,200	56,600	70,100	83,500	96,900	110,300
~200		16,100	32,200	46,900	61,500	76,200	90,800	105,400	120,100
~220		17,400	34,700	50,500	66,400	82,300	98,100	114,000	129,800
~240		18,600	37,100	54,200	71,300	88,400	105,400	122,500	139,600
~260		19,800	39,600	57,900	76,200	94,500	112,800	131,100	149,400
~280		21,000	42,000	61,500	81,000	100,600	120,100	139,600	159,100
約1.5倍ヒダ		~88	~200	~300	~400	~500	~600	~700	~800
フラット前ヒダ		~130	~260	~410	~560				

H	W	~67 1巾(片開き)	~150 2巾	~225 3巾	~300 4巾	~375 5巾	~450 6巾	~525 7巾	~600 8巾
~100		11,700	23,400	33,600	43,800	54,100	64,300	74,500	84,700
~120		13,200	26,300	38,000	49,700	61,400	73,000	84,700	96,400
~140		14,600	29,200	42,400	55,500	68,700	81,800	94,900	108,100
~160		16,100	32,200	46,800	61,400	76,000	90,600	105,200	119,800
~180		17,600	35,100	51,100	67,200	83,300	99,300	115,400	131,400
~200		19,000	38,000	55,500	73,000	90,600	108,100	125,600	143,100
~220		20,500	40,900	59,900	78,900	97,900	116,800	135,800	154,800
~240		21,900	43,800	64,300	84,700	105,200	125,600	146,000	166,500
~260		23,400	46,800	68,700	90,600	112,500	134,400	156,300	178,200

※片開きはW300cmまで

		コード式				ドラム式							
H	W	30~45	~90	~140	~240	30~45	~90	~140	~190	~240	~290	~340	~390
50~100		14,600	18,600	23,200	31,600	17,600	21,600	26,200	34,600	39,300	46,500	55,700	60,500
~140		17,000	21,100	25,800	35,700	20,000	24,100	28,800	38,700	43,600	51,200	62,000	66,900
~180		19,300	23,400	28,400	39,800	22,300	26,400	31,400	42,800	48,000	55,600	68,000	73,100
~220		21,700	25,900	31,100	44,000	24,700	28,900	34,100	47,000	52,300	60,300	74,300	79,400
~260		24,000	28,300	33,700	48,100	27,000	31,300	36,700	51,100	56,600	64,700	80,500	85,600
~300		26,400	30,700	36,300	52,200	29,400	33,700	39,300	55,200	61,000	69,400	86,600	91,900

※ドラム式: 仕上り巾39cm以下の場合、仕上り丈は200cmまでとなります。

		コード式	
H	W	18~30	18~30
50~100		18~30	19,200
~140		18~30	22,100
~180		18~30	24,400
~220		18~30	27,300
~240		18~30	29,000

		コード式				ドラム式							
H	W	30~45	~90	~140	~240	30~45	~90	~140	~190	~240	~290	~340	~390
50~100		17,400	23,600	30,300	41,500	20,400	26,600	33,300	44,500	50,900	59,100	70,300	76,800
~140		20,000	26,700	33,800	47,000	23,000	29,700	36,800	50,000	57,000	65,500	78,600	85,500
~180		22,500	29,700	37,200	52,500	25,500	32,700	40,200	55,500	63,100	72,000	87,300	94,500
~220		25,200	32,700	40,700	58,000	28,200	35,700	43,700	61,000	69,200	78,400	95,400	103,000
~260		27,800	36,000	44,600	64,100	30,800	39,000	47,600	67,100	75,900	85,700	104,700	112,800
~300		30,600	39,300	48,500	70,100	33,600	42,300	51,500	73,100	82,700	93,000	114,000	122,700

※ドラム式: 仕上り巾39cm以下の場合、仕上り丈は200cmまでとなります。

		38mm (片開き/タッセルなし)					
H	W	~72	~100	~127	~155	~183	
~100		14,900	23,500	27,700	29,800	38,400	
~140		16,800	27,300	31,500	33,600	44,000	
~180		18,700	31,000	35,200	37,300	49,600	
~220		20,500	34,700	38,900	41,000	55,100	
~260		22,400	38,400	42,600	44,700	60,700	
~300		24,200	42,100	46,300	48,400	66,300	
26mm		-2,800	-2,100	-4,900	-4,200	-4,900	
18mm		-4,900	-5,600	-9,100	-9,800	-10,500	

※生地を伸ばした状態のサイズでご発注ください。

		スプリング・チェーンタイプ				
H	W	30~60	~80	~100	~120	~140
50~80		30,000	32,500	34,500	35,700	37,400
~120		32,500	35,600	37,600	38,700	40,600
~160		34,900	38,700	40,700	41,900	43,200
~200		38,500	41,500	43,700	44,900	46,200
~240			44,500	46,800	48,000	49,400

※丈は巾の3倍までが限度です。
※ロールソフト加工品は非防災品になります。

		ストレートバランス				
H	W	~100	~150	~200	~250	~300
~40		10,900	17,400	21,800	26,200	32,600

※マジックテープ仕様・裏面スポンジ付の価格になります。

H	W	~100	~150	~200	~250	~300
~40		9,000	12,900	16,800	21,700	23,200

※マジックテープ仕様の価格になります。

プレーン		パイピング	
サイズ	価格	サイズ	価格
40x40	6,400	40x40	7,200
45x45	7,800	45x45	8,600
フリール付			
40x40	10,200	45x45	9,800
45x45	11,900	40x40	9,800
		45x45	11,600

※中材込みの価格になります。

遮光

TM-54250~54253



巾 ◇ 150cm 価格 ◇ 6,750円/m
組成 ◇ ポリエステル100%

リポート ◇ タテ cm ヨコ 7.8 cm
寸法変化率 ◇ 水洗い/タテ -0.2% ヨコ -0.2%
ドライ/タテ -0.3% ヨコ 0.0%

取扱い表示 ◇ リ-30 40 30 10 10 10 10 10
防炎性能 ◇ (イ) ちて布使用
Made in Japan

H	W	~67 1巾(片開き)	~150 2巾	~225 3巾	~300 4巾	~375 5巾	~450 6巾	~525 7巾
~100		14,400	28,700	41,100	53,500	65,900	78,300	90,700
~120		16,200	32,300	46,400	60,600	74,700	88,900	103,100
~140		17,900	35,800	51,700	67,700	83,600	99,500	115,500
~160		19,700	39,300	57,000	74,700	92,400	110,100	127,800
~180		21,500	42,900	62,400	81,800	101,300	120,800	140,200
~200		23,200	46,400	67,700	88,900	110,100	131,400	152,600
~220		25,000	50,000	73,000	96,000	119,000	142,000	165,000
~240		26,800	53,500	78,300	103,100	127,800	152,600	177,400
~260		28,500	57,000	83,600	110,100	136,700	163,200	189,800
~280		30,300	60,600	88,900	117,200	145,500	173,900	202,200
約1.5倍ヒダ		~88	~200	~300	~400	~500		

※片開きはW270cmまで

H	W	~67 1巾(片開き)	~150 2巾	~225 3巾	~300 4巾	~375 5巾	~450 6巾	~525 7巾
~100		14,800	29,600	42,400	55,200	68,000	80,800	93,600
~120		16,600	33,200	47,900	62,500	77,100	91,800	106,400
~140		18,500	36,900	53,400	69,800	86,300	102,800	119,200
~160		20,300	40,500	58,800	77,100	95,400	113,700	132,000
~180		22,100	44,200	64,300	84,500	104,600	124,700	144,900
~200		24,000	47,900	69,800	91,800	113,700	135,700	157,700
~220		25,800	51,500	75,300	99,100	122,900	146,700	170,500
~240		27,600	55,200	80,800	106,400	132,000	157,700	183,300
~260		29,400	58,800	86,300	113,700	141,200	168,600	196,100
~280		31,300	62,500	91,800	121,100	150,300	179,600	208,900
約1.5倍ヒダ		~88	~200	~300	~400	~500		

※片開きはW270cmまで

H	W	~67 1巾(片開き)	~150 2巾	~225 3巾	~300 4巾	~375 5巾	~450 6巾	~525 7巾	~600 8巾
~100		14,000	27,900	39,900	51,800	63,800	75,800	87,700	99,700
~120		15,700	31,300	45,000	58,700	72,300	86,000	99,700	113,400
~140		17,400	34,700	50,100	65,500	80,900	96,300	111,700	127,100
~160		19,100	38,100	55,200	72,300	89,400	106,500	123,600	140,700
~180		20,800	41,600	60,400	79,200	98,000	116,800	135,600	154,400
~200		22,500	45,000	65,500	86,000	106,500	127,100	147,600	168,100
~220		24,200	48,400	70,600	92,900	115,100	137,300	159,600	181,800
~240		25,900	51,800	75,800	99,700	123,600	147,600	171,500	195,500
~260		27,600	55,200	80,900	106,500	132,200	157,800	183,500	209,100
~280		29,400	58,700	86,000	113,400	140,700	168,100	195,500	222,800
約1.5倍ヒダ		~88	~200	~300	~400	~500	~600	~700	~800
フラット前ヒダ		~130	~260	~410	~560				

H	W	~67 1巾(片開き)	~150 2巾	~225 3巾	~300 4巾	~375 5巾	~450 6巾	~525 7巾	~600 8巾
~100		15,600	31,200	44,900	58,500	72,200	85,800	99,500	113,100
~120		17,600	35,100	50,700	66,300	81,900	97,500	113,100	128,700
~140		19,500	39,000	56,600	74,100	91,700	109,200	126,800	144,300
~160		21,500	42,900	62,400	81,900	101,400	120,900	140,400	159,900
~180		23,400	46,800	68,300	89,700	111,200	132,600	154,100	175,500
~200		25,400	50,700	74,100	97,500	120,900	144,300	167,700	191,100
~220		27,300	54,600	80,000	105,300	130,700	156,000	181,400	206,700
~240		29,300	58,500	85,800	113,100	140,400	167,700	195,000	222,300
~260		31,200	62,400	91,700	120,900	150,200	179,400	208,700	237,900

※片開きはW300cmまで

		コード式				ドラム式								
H	W	30~45	~90	~140	~190	~240	30~45	~90	~140	~190	~240	~290	~340	~390
50~100		17,200	21,200	25,700	36,500	41,200	20,200	24,200	28,700	39,500	44,200	51,600	63,300	68,100
~140		20,400	24,400	29,200	42,300	47,200	23,400	27,400	32,200	45,300	50,200	57,900	72,100	77,000
~180		23,600	27,600	32,700	48,100	53,200	26,600	30,600	35,700	51,100	56,200	64,100	80,700	85,700
~220		26,900	30,900	36,100	53,800	59,200	29,900	33,900	39,100	56,800	62,200	70,400	89,500	94,600
~260		30,000	34,200	39,600	59,600	65,100	33,000	37,200	42,600	62,600	68,100	76,500	98,200	103,200
~300		33,300	37,500	43,100	65,400	71,200	36,300	40,500	46,100	68,400	74,200	82,900	106,800	112,200

※ドラム式：仕上り巾39cm以下の場合、仕上り丈は200cmまでとなります。

		コード式
H	W	18~30
50~100		21,500
~140		25,200
~180		28,300
~220		32,000
~240		34,100

		コード式				ドラム式								
H	W	30~45	~90	~140	~190	~240	30~45	~90	~140	~190	~240	~290	~340	~390
50~100		20,000	26,300	32,900	46,800	53,200	23,000	29,300	35,900	49,800	56,200	64,300	78,200	84,800
~140		23,500	30,200	37,300	54,100	61,000	26,500	33,200	40,300	57,100	64,000	72,600	89,200	96,100
~180		27,000	34,100	41,600	61,400	68,900	30,000	37,100	44,600	64,400	71,900	80,800	100,500	107,800
~220		30,400	38,000	46,000	68,600	76,800	33,400	41,000	49,000	71,600	79,800	89,000	111,300	118,900
~260		34,000	42,200	50,800	76,500	85,300	37,000	45,200	53,800	79,500	88,300	98,100	123,200	131,400
~300		37,700	46,300	55,600	84,300	93,800	40,700	49,300	58,600	87,300	96,800	107,100	135,200	143,800

※ドラム式：仕上り巾39cm以下の場合、仕上り丈は200cmまでとなります。

		スプリング・チェーンタイプ				
H	W	30~60	~80	~100	~120	~140
50~80		32,300	34,800	36,800	38,000	39,700
~120		35,600	38,700	40,700	41,800	43,700
~160		38,800	42,600	44,600	45,800	47,100
~200		43,200	46,200	48,400	49,600	50,900
~240			50,000	52,300	53,500	54,900

※丈は巾の3倍までが限度です。
※ロールソフト加工品は非防災品になります。

		38mm (片開き/タッセルなし)				
H	W	~72	~100	~127	~155	~183
~100		17,700	29,000	33,200	35,300	46,700
~140		20,300	34,300	38,500	40,600	54,600
~180		23,000	39,600	43,800	45,900	62,500
~220		25,600	44,900	49,100	51,200	70,400
~260		28,200	50,100	54,300	56,400	78,300
~300		30,900	55,400	59,600	61,700	86,300
26mm		-2,800	-2,100	-4,900	-4,200	-4,900
18mm		-4,900	-5,600	-9,100	-9,800	-10,500

※生地を伸ばした状態のサイズでご発注ください。

		ストレートバランス				
H	W	~100	~150	~200	~250	~300
~40		12,100	19,700	24,100	28,500	36,200

※マジックテープ仕様・裏面スポンジ付の価格になります。

H	W	~100	~150	~200	~250	~300
~40		11,700	17,000	22,300	28,500	30,000

※マジックテープ仕様の価格になります。

プレーン		パイピング	
サイズ	価格	サイズ	価格
40x40	7,300	40x40	8,400
45x45	8,700	45x45	9,800
フレーム付			
40x40	12,500	45x45	14,500
40x40	12,500	45x45	13,900

※中材込みの価格になります。

遮光

TM-54254・54255



巾 ◇ 150cm 価格 ◇ 4,200円/m リポート ◇ タテ cm ヨコ 15.0cm 取扱表示 ◇ リ-30 40 防炎性能 ◇ (イ) であて布使用
 組成 ◇ ポリエステル100% 寸法変化率 ◇ 水洗い/タテ 0.2% ヨコ 0.2% ドライ/タテ -0.2% ヨコ -0.2% Made in Japan

H	W	~67 1巾(片開き)	~150 2巾	~225 3巾	~300 4巾	~375 5巾	~450 6巾	~525 7巾
~100		10,300	20,600	29,400	38,200	47,000	55,800	64,700
~120		11,600	23,100	33,200	43,200	53,300	63,400	73,500
~140		12,800	25,600	36,900	48,300	59,600	71,000	82,300
~160		14,100	28,100	40,700	53,300	65,900	78,500	91,100
~180		15,300	30,600	44,500	58,400	72,200	86,100	99,900
~200		16,600	33,200	48,300	63,400	78,500	93,600	108,800
~220		17,900	35,700	52,100	68,400	84,800	101,200	117,600
~240		19,100	38,200	55,800	73,500	91,100	108,800	126,400
~260		20,400	40,700	59,600	78,500	97,400	116,300	135,200
~280		21,600	43,200	63,400	83,600	103,700	123,900	144,000
約1.5倍ヒダ		~88	~200	~300	~400	~500		

※片開きはW270cmまで

H	W	~67 1巾(片開き)	~150 2巾	~225 3巾	~300 4巾	~375 5巾	~450 6巾	~525 7巾
~100		10,700	21,400	30,600	39,900	49,100	58,400	67,600
~120		12,000	24,000	34,600	45,200	55,700	66,300	76,800
~140		13,400	26,700	38,600	50,400	62,300	74,200	86,100
~160		14,700	29,300	42,500	55,700	68,900	82,100	95,300
~180		16,000	32,000	46,500	61,000	75,500	90,000	104,600
~200		17,300	34,600	50,400	66,300	82,100	98,000	113,800
~220		18,600	37,200	54,400	71,600	88,700	105,900	123,000
~240		20,000	39,900	58,400	76,800	95,300	113,800	132,300
~260		21,300	42,500	62,300	82,100	101,900	121,700	141,500
~280		22,600	45,200	66,300	87,400	108,500	129,600	150,800
約1.5倍ヒダ		~88	~200	~300	~400	~500		

※片開きはW270cmまで

H	W	~67 1巾(片開き)	~150 2巾	~225 3巾	~300 4巾	~375 5巾	~450 6巾	~525 7巾	~600 8巾
~100		9,900	19,700	28,100	36,500	44,900	53,300	61,700	70,100
~120		11,100	22,100	31,700	41,300	50,900	60,500	70,100	79,700
~140		12,300	24,500	35,300	46,100	56,900	67,700	78,500	89,300
~160		13,500	26,900	38,900	50,900	62,900	74,900	86,900	98,900
~180		14,700	29,300	42,500	55,700	68,900	82,100	95,300	108,500
~200		15,900	31,700	46,100	60,500	74,900	89,300	103,700	118,100
~220		17,100	34,100	49,700	65,300	80,900	96,500	112,100	127,700
~240		18,300	36,500	53,300	70,100	86,900	103,700	120,500	137,300
~260		19,500	38,900	56,900	74,900	92,900	110,900	128,900	146,900
~280		20,700	41,300	60,500	79,700	98,900	118,100	137,300	156,500
約1.5倍ヒダ		~88	~200	~300	~400	~500	~600	~700	~800
フラット前1倍ヒダ		~130	~260	~410	~560				

H	W	~67 1巾(片開き)	~150 2巾	~225 3巾	~300 4巾	~375 5巾	~450 6巾	~525 7巾	~600 8巾
~100		9,900	23,100	33,200	43,200	53,300	63,400	73,500	83,600
~120		13,000	26,000	37,500	49,000	60,500	72,000	83,600	95,100
~140		14,400	28,800	41,800	54,800	67,700	80,700	93,600	106,600
~160		15,900	31,700	46,100	60,500	74,900	89,300	103,700	118,100
~180		17,300	34,600	50,400	66,300	82,100	98,000	113,800	129,600
~200		18,800	37,500	54,800	72,000	89,300	106,600	123,900	141,200
~220		20,200	40,400	59,100	77,800	96,500	115,200	134,000	152,700
~240		21,600	43,200	63,400	83,600	103,700	123,900	144,000	164,200
~260		23,100	46,100	67,700	89,300	110,900	132,500	154,100	175,700

※片開きはW300cmまで

		コード式				ドラム式								
H	W	30~45	~90	~140	~190	30~45	~90	~140	~190	~240	~290	~340	~390	
50~100		14,500	18,500	23,100	31,400	36,100	17,500	21,500	26,100	34,400	39,100	46,300	55,400	60,200
~140		16,800	20,900	25,700	35,400	40,400	19,800	23,900	28,700	38,400	43,400	50,900	61,600	66,500
~180		19,100	23,300	28,300	39,500	44,600	22,100	26,300	31,300	42,500	47,600	55,300	67,500	72,500
~220		21,500	25,700	30,900	43,500	48,900	24,500	28,700	33,900	46,500	51,900	59,900	73,700	78,800
~260		23,800	28,000	33,500	47,600	53,100	26,800	31,000	36,500	50,600	56,100	64,200	79,800	84,800
~300		26,100	30,400	36,100	51,700	57,400	29,100	33,400	39,100	54,700	60,400	68,900	85,800	91,100

※ドラム式：仕上り巾39cm以下の場合、仕上り丈は200cmまでとなります。

		コード式
H	W	18~30
50~100		19,100
~140		21,900
~180		24,300
~220		27,100
~240		28,800

		コード式				ドラム式								
H	W	30~45	~90	~140	~190	30~45	~90	~140	~190	~240	~290	~340	~390	
50~100		17,300	23,500	30,200	41,300	47,700	20,300	26,500	33,200	44,300	50,700	58,800	69,900	76,500
~140		19,800	26,500	33,600	46,700	53,700	22,800	29,500	36,600	49,700	56,700	65,200	78,200	85,100
~180		22,400	29,500	37,000	52,200	59,700	25,400	32,500	40,000	55,200	62,700	71,600	86,700	94,000
~220		24,900	32,500	40,500	57,600	65,700	27,900	35,500	43,500	60,600	68,700	78,000	94,700	102,400
~260		27,600	35,700	44,400	63,600	72,400	30,600	38,700	47,400	66,600	75,400	85,200	103,900	112,100
~300		30,300	39,000	48,300	69,600	79,100	33,300	42,000	51,300	72,600	82,100	92,400	113,100	121,800

※ドラム式：仕上り巾39cm以下の場合、仕上り丈は200cmまでとなります。

		(片開き/タッセルなし)				
H	W	~72	~100	~127	~155	~183
~100		14,800	23,300	27,500	29,600	38,100
~140		16,700	27,000	31,200	33,300	43,600
~180		18,500	30,600	34,800	36,900	49,000
~220		20,300	34,300	38,500	40,600	54,500
~260		22,100	37,900	42,100	44,200	60,000
~300		24,000	41,600	45,800	47,900	65,500
26mm		-2,800	-2,100	-4,900	-4,200	-4,900
18mm		-4,900	-5,600	-9,100	-9,800	-10,500

※生地を伸ばした状態のサイズでご発注ください。

		スプリング・チェーンタイプ				
H	W	30~60	~80	~100	~120	~140
50~80		29,900	32,400	34,400	35,600	37,300
~120		32,300	35,400	37,400	38,500	40,400
~160		34,800	38,600	40,600	41,800	43,100
~200		38,300	41,300	43,500	44,700	46,000
~240			44,300	46,600	47,800	49,200

※丈は巾の3倍までが限度です。
 ※ロールソフト加工品は非防炎品になります。

		ストレートバランス				
H	W	~100	~150	~200	~250	~300
~40		10,900	17,300	21,700	26,100	32,500

※マジックテープ仕様・裏面スポンジ付の価格になります。

		三ツ山・箱ヒダバランス (約2.5倍ヒダ)				
H	W	~100	~150	~200	~250	~300
~40		8,900	12,700	16,600	21,400	22,900

※マジックテープ仕様の価格になります。

TM-54256~54259

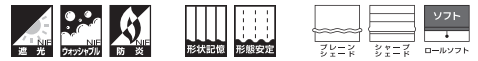

巾 ◇ 150cm 価格 ◇ 3,700円/m
組成 ◇ ポリエステル100%

リポート ◇ タテ 31.8cm ヨコ 50.0cm
寸法変化率 ◇ 水洗い/タテ 0.0% ヨコ 0.0%
ドライ/タテ 0.0% ヨコ 0.0%

取扱い表示 ◇ リ-30 30 40 50 60 70 80 90 100
防炎性能 ◇ (イ) あて布使用
Made in Japan

H	W	~67 1巾(片開き)	~150 2巾	~225 3巾	~300 4巾	~375 5巾	~450 6巾	~525 7巾
~100		10,700	21,300	30,600	39,800	49,100	58,400	67,700
~120		10,700	21,300	30,600	39,800	49,100	58,400	67,700
~140		12,500	25,400	36,400	47,500	58,400	69,500	80,400
~160		14,800	28,900	41,700	54,400	67,700	80,400	93,200
~180		14,800	28,900	41,700	54,400	67,700	80,400	93,200
~200		16,500	32,400	47,500	61,900	77,000	91,500	106,000
~220		18,300	36,400	52,600	69,500	86,200	102,500	119,400
~240		18,300	36,400	52,600	69,500	86,200	102,500	119,400
~260		19,900	39,800	58,400	77,000	95,000	113,600	132,100
~280		19,900	39,800	58,400	77,000	95,000	113,600	132,100
約1.5倍ヒダ		~88	~200	~300	~400	~500		

※片開きはW270cmまで

H	W	~67 1巾(片開き)	~150 2巾	~225 3巾	~300 4巾	~375 5巾	~450 6巾	~525 7巾
~100		11,100	22,200	32,000	41,800	51,500	61,300	71,000
~120		11,100	22,200	32,000	41,800	51,500	61,300	71,000
~140		13,100	26,600	38,100	49,800	61,300	73,000	84,500
~160		15,500	30,300	43,700	57,100	71,000	84,500	97,900
~180		15,500	30,300	43,700	57,100	71,000	84,500	97,900
~200		17,200	33,900	49,800	64,900	80,800	96,100	111,300
~220		19,200	38,100	55,200	73,000	90,600	107,600	125,400
~240		19,200	38,100	55,200	73,000	90,600	107,600	125,400
~260		20,900	41,800	61,300	80,800	99,800	119,300	138,800
~280		20,900	41,800	61,300	80,800	99,800	119,300	138,800
約1.5倍ヒダ		~88	~200	~300	~400	~500		

※片開きはW270cmまで

H	W	~67 1巾(片開き)	~150 2巾	~225 3巾	~300 4巾	~375 5巾	~450 6巾	~525 7巾	~600 8巾
~100		10,200	20,300	29,100	37,900	46,700	55,500	64,300	73,100
~120		10,200	20,300	29,100	37,900	46,700	55,500	64,300	73,100
~140		11,900	24,200	34,600	45,100	55,500	66,000	76,400	86,900
~160		14,100	27,500	39,600	51,700	64,300	76,400	88,500	100,600
~180		14,100	27,500	39,600	51,700	64,300	76,400	88,500	100,600
~200		15,700	30,800	45,100	58,800	73,100	86,900	100,600	114,900
~220		17,400	34,600	50,000	66,000	81,900	97,300	113,300	128,700
~240		17,400	34,600	50,000	66,000	81,900	97,300	113,300	128,700
~260		19,000	37,900	55,500	73,100	90,200	107,800	125,400	143,000
~280		19,000	37,900	55,500	73,100	90,200	107,800	125,400	143,000
約1.5倍ヒダ		~88	~200	~300	~400	~500	~600	~700	~800
フラット前ヒダ		~130	~260	~410	~560				

H	W	~67 1巾(片開き)	~150 2巾	~225 3巾	~300 4巾	~375 5巾	~450 6巾	~525 7巾	~600 8巾
~100		12,100	24,200	34,900	45,600	56,300	67,000	77,800	88,500
~120		12,100	24,200	34,900	45,600	56,300	67,000	77,800	88,500
~140		14,200	29,000	41,600	54,400	67,000	79,900	92,500	105,300
~160		16,900	33,000	47,700	62,500	77,800	92,500	107,200	122,000
~180		16,900	33,000	47,700	62,500	77,800	92,500	107,200	122,000
~200		18,800	37,000	54,400	71,100	88,500	105,300	122,000	139,400
~220		20,900	41,600	60,300	79,900	99,200	118,000	137,500	156,300
~240		20,900	41,600	60,300	79,900	99,200	118,000	137,500	156,300
~260		22,800	45,600	67,000	88,500	109,400	130,800	152,200	173,700

※片開きはW300cmまで

		コード式				ドラム式								
H	W	30~45	~90	~140	~190	~240	30~45	~90	~140	~190	~240	~290	~340	~390
50~100		14,300	18,300	22,900	31,000	35,700	17,300	21,300	25,900	34,000	38,700	45,900	54,800	59,600
~140		16,100	20,200	25,000	34,100	39,000	19,100	23,200	28,000	37,100	42,000	49,500	59,500	64,400
~180		19,200	23,300	28,400	39,400	44,500	22,200	26,300	31,400	42,400	47,500	55,200	67,200	72,200
~220		21,100	25,300	30,500	42,500	47,800	24,100	28,300	33,500	45,500	50,800	58,800	72,200	77,300
~260		22,900	27,100	32,600	45,900	51,400	25,900	30,100	35,600	48,900	54,400	62,500	76,900	81,900
~300		24,700	29,100	34,700	49,000	54,800	27,700	32,100	37,700	52,000	57,800	66,100	81,600	87,000

※ドラム式: 仕上り巾39cm以下の場合、仕上り丈は200cmまでとなります。

		コード式	
H	W	18~30	18~90
50~100		18,300	18,900
~140		21,300	
~180		24,400	
~220		26,700	
~240		28,600	

		コード式				ドラム式								
H	W	30~45	~90	~140	~190	~240	30~45	~90	~140	~190	~240	~290	~340	~390
50~100		17,000	23,300	29,900	40,900	47,200	20,000	26,300	32,900	43,900	50,200	58,400	69,300	75,900
~140		19,100	25,800	32,900	45,300	52,300	22,100	28,800	35,900	48,300	55,300	63,800	76,000	82,900
~180		22,500	29,600	37,100	52,000	59,600	25,500	32,600	40,100	55,000	62,600	71,500	86,300	93,600
~220		24,500	32,100	40,100	56,400	64,600	27,500	35,100	43,100	59,400	67,600	76,800	93,200	100,800
~260		26,700	34,800	43,500	61,800	70,600	29,700	37,800	46,500	64,800	73,600	83,400	100,800	109,000
~300		28,900	37,600	46,800	66,700	76,300	31,900	40,600	49,800	69,700	79,300	89,500	108,800	117,500

※ドラム式: 仕上り巾39cm以下の場合、仕上り丈は200cmまでとなります。

		38mm (片開き/タッセルなし)					
H	W	~72	~100	~127	~155	~183	
~100		15,100	23,900	28,100	30,200	38,900	
~140		16,400	26,800	31,000	33,100	43,100	
~180		18,100	29,300	33,500	35,600	46,900	
~220		20,600	34,700	38,900	41,000	54,700	
~260		21,800	37,200	41,400	43,500	58,900	
~300		23,000	39,700	43,900	46,000	62,700	
26mm		-2,800	-2,100	-4,900	-4,200	-4,900	
18mm		-4,900	-5,600	-9,100	-9,800	-10,500	

※生地を伸ばした状態のサイズでご発注ください。

		スプリング・チェーンタイプ				
H	W	30~60	~80	~100	~120	~140
50~80		29,700	32,200	34,200	35,400	37,100
~120		31,700	34,800	36,800	37,900	39,800
~160		34,900	38,700	40,700	41,900	43,200
~200		37,900	40,900	43,100	44,300	45,600
~240			43,400	45,700	46,900	48,300

※丈は巾の3倍までが限度です。
※ロールソフト加工品は非防災品になります。

		ストレートバランス				
H	W	~100	~150	~200	~250	~300
~40		10,900	17,100	21,500	25,900	32,100

※マジックテープ仕様・裏面スポンジ付の価格になります。

H	W	~100	~150	~200	~250	~300
~40		9,800	14,200	18,700	23,900	25,400

※マジックテープ仕様の価格になります。

遮光

TM-54260・54261

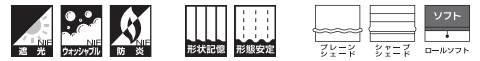

巾 ◇ 150cm 価格 ◇ 3,800円/m リポート ◇ タテ61.0cm ヨコ75.0cm 取扱い表示 ◇ リ-30 40 防炎性能 ◇ (イ) であて布使用
 組成 ◇ ポリエステル100% 寸法変化率 ◇ 水洗い/タテ -0.7% ヨコ -0.5% ドライ/タテ -0.3% ヨコ -0.2% Made in Japan

H	W	~67 1巾(片開き)	~150 2巾	~225 3巾	~300 4巾	~375 5巾	~450 6巾	~525 7巾
~100		12,700	24,700	35,300	46,400	57,000	67,700	78,900
~120		12,700	24,700	35,300	46,400	57,000	67,700	78,900
~140		12,700	24,700	35,300	46,400	57,000	67,700	78,900
~160		16,200	31,700	46,400	60,600	74,700	89,600	103,700
~180		16,200	31,700	46,400	60,600	74,700	89,600	103,700
~200		16,200	31,700	46,400	60,600	74,700	89,600	103,700
~220		19,800	38,800	57,000	74,700	93,100	110,800	129,000
~240		19,800	38,800	57,000	74,700	93,100	110,800	129,000
~260		19,800	38,800	57,000	74,700	93,100	110,800	129,000
~280		23,300	46,400	67,700	89,600	110,800	132,600	154,500
約1.5倍ヒダ		~88	~200	~300	~400	~500		

※片開きはW270cmまで

H	W	~67 1巾(片開き)	~150 2巾	~225 3巾	~300 4巾	~375 5巾	~450 6巾	~525 7巾
~100		13,300	25,800	36,900	48,600	59,800	71,000	82,800
~120		13,300	25,800	36,900	48,600	59,800	71,000	82,800
~140		13,300	25,800	36,900	48,600	59,800	71,000	82,800
~160		17,000	33,200	48,600	63,500	78,400	94,000	108,900
~180		17,000	33,200	48,600	63,500	78,400	94,000	108,900
~200		17,000	33,200	48,600	63,500	78,400	94,000	108,900
~220		20,700	40,700	59,800	78,400	97,700	116,300	135,400
~240		20,700	40,700	59,800	78,400	97,700	116,300	135,400
~260		20,700	40,700	59,800	78,400	97,700	116,300	135,400
~280		24,400	48,600	71,000	94,000	116,300	139,200	162,200
約1.5倍ヒダ		~88	~200	~300	~400	~500		

※片開きはW270cmまで

H	W	~67 1巾(片開き)	~150 2巾	~225 3巾	~300 4巾	~375 5巾	~450 6巾	~525 7巾	~600 8巾
~100		12,100	23,500	33,600	44,200	54,300	64,400	75,100	85,100
~120		12,100	23,500	33,600	44,200	54,300	64,400	75,100	85,100
~140		12,100	23,500	33,600	44,200	54,300	64,400	75,100	85,100
~160		15,500	30,300	44,200	57,600	71,100	85,100	98,600	112,500
~180		15,500	30,300	44,200	57,600	71,100	85,100	98,600	112,500
~200		15,500	30,300	44,200	57,600	71,100	85,100	98,600	112,500
~220		18,800	37,000	54,300	71,100	88,500	105,300	122,600	139,400
~240		18,800	37,000	54,300	71,100	88,500	105,300	122,600	139,400
~260		18,800	37,000	54,300	71,100	88,500	105,300	122,600	139,400
~280		22,200	44,200	64,400	85,100	105,300	126,000	146,700	166,900
約1.5倍ヒダ		~88	~200	~300	~400	~500	~600	~700	~800
フラット前1倍ヒダ		~130	~260	~410	~560				

H	W	~67 1巾(片開き)	~150 2巾	~225 3巾	~300 4巾	~375 5巾	~450 6巾	~525 7巾	~600 8巾
~100		14,400	28,000	40,300	53,100	65,300	77,600	90,600	102,800
~120		14,400	28,000	40,300	53,100	65,300	77,600	90,600	102,800
~140		14,400	28,000	40,300	53,100	65,300	77,600	90,600	102,800
~160		18,500	36,200	53,100	69,400	85,700	102,800	119,100	136,000
~180		18,500	36,200	53,100	69,400	85,700	102,800	119,100	136,000
~200		18,500	36,200	53,100	69,400	85,700	102,800	119,100	136,000
~220		22,600	44,300	65,300	85,700	106,900	127,300	148,300	168,700
~240		22,600	44,300	65,300	85,700	106,900	127,300	148,300	168,700
~260		22,600	44,300	65,300	85,700	106,900	127,300	148,300	168,700
~280		26,600	53,100	77,600	102,800	127,300	154,500	181,100	208,900
約1.5倍ヒダ		~88	~200	~300	~400	~500	~600	~700	~800

※片開きはW300cmまで

		コード式				ドラム式								
H	W	30~45	~90	~140	~190	30~45	~90	~140	~190	~240	~290	~340	~390	
50~100		14,400	18,400	23,000	30,900	35,600	17,400	21,400	26,000	33,900	38,600	45,800	54,500	59,300
~140		17,300	21,400	26,100	36,000	40,900	20,300	24,400	29,100	39,000	43,900	51,500	62,200	67,100
~180		20,100	24,200	29,200	41,000	46,100	23,100	27,200	32,200	44,000	49,100	56,900	70,000	75,100
~220		21,000	25,200	30,400	42,300	47,600	24,000	28,200	33,400	45,300	50,600	58,500	71,800	77,000
~260		23,800	28,000	33,500	47,300	52,800	26,800	31,000	36,500	50,300	55,800	64,000	79,600	84,600
~300		26,700	31,000	36,600	52,700	58,500	29,700	34,000	39,600	55,700	61,500	69,900	87,000	92,400

※ドラム式: 仕上り巾39cm以下の場合、仕上り丈は200cmまでとなります。

		コード式	
H	W	18~30	19,000
50~100		18~30	19,000
~140		22,300	
~180		25,100	
~220		26,600	
~240		29,500	

		コード式				ドラム式								
H	W	30~45	~90	~140	~190	30~45	~90	~140	~190	~240	~290	~340	~390	
50~100		17,200	23,500	30,100	40,800	47,100	20,200	26,500	33,100	43,800	50,100	58,300	69,000	75,600
~140		20,300	27,000	34,100	47,300	54,200	23,300	30,000	37,100	50,300	57,200	65,800	78,900	85,700
~180		23,400	30,500	38,000	53,800	61,400	26,400	33,500	41,000	56,800	64,400	73,300	89,300	96,600
~220		24,400	32,000	40,000	56,200	64,400	27,400	35,000	43,000	59,200	67,400	76,600	92,800	100,500
~260		27,600	35,800	44,400	63,300	72,100	30,600	38,800	47,400	66,300	75,100	84,900	103,700	111,800
~300		30,900	39,600	48,800	70,700	80,300	33,900	42,600	51,800	73,700	83,300	93,500	114,500	123,100

※ドラム式: 仕上り巾39cm以下の場合、仕上り丈は200cmまでとなります。

		(片開き/タッセルなし)					
H	W	~72	~100	~127	~155	~183	
38mm							
50~100		16,500	26,300	30,500	32,600	42,300	
~140		16,500	26,300	30,500	32,600	42,300	
~180		19,100	31,400	35,600	37,700	50,300	
~220		21,600	36,500	40,700	42,800	58,000	
~260		21,600	36,500	40,700	42,800	58,000	
~300		24,200	41,900	46,100	48,200	65,600	
26mm		-2,800	-2,100	-4,900	-4,200	-4,900	
18mm		-4,900	-5,600	-9,100	-9,800	-10,500	

※生地を伸ばした状態のサイズでご発注ください。

		スプリング・チェーンタイプ				
H	W	30~60	~80	~100	~120	~140
50~80		29,800	32,300	34,300	35,500	37,200
~120		32,700	35,800	37,800	38,900	40,800
~160		35,600	39,400	41,400	42,600	43,900
~200		37,800	40,800	43,000	44,200	45,500
~240			44,300	46,600	47,800	49,200

※丈は巾の3倍までが限度です。
 ※ロールソフト加工品は非防炎品になります。

		ストレートバランス				
H	W	~100	~150	~200	~250	~300
~40		11,000	17,200	21,600	26,000	32,200

※マジックテープ仕様・裏面スポンジ付の価格になります。

		三ツ山・箱ヒダバランス (約2.5倍ヒダ)				
H	W	~100	~150	~200	~250	~300
~40		11,700	16,900	22,000	28,200	29,700

※マジックテープ仕様の価格になります。

TM-54284~54303



巾 ◇ 100cm 価格 ◇ 1,800円/m
組成 ◇ ポリエステル100%

リポート ◇ タテ cm ヨコ cm
寸法変化率 ◇ 水洗い/タテ -0.3% ヨコ 0.0%
ドライ/タテ -0.3% ヨコ 0.0%

取扱い表示 ◇ リ-30 40 30 20 10 5
防炎性能 ◇ (イ) あて布使用
Made in Japan

標準仕様 形態安定加工価格表 約2倍ヒダ (タッセル含む)

H	W	~44 1巾(片開き)	~100 2巾	~150 3巾	~200 4巾	~250 5巾	~300 6巾	~350 7巾	~400 8巾
~100		5,500	10,900	15,400	19,900	24,400	28,800	33,300	37,800
~120		6,100	12,200	17,300	22,400	27,600	32,700	37,800	42,900
~140		6,800	13,500	19,200	25,000	30,800	36,500	42,300	48,000
~160		7,400	14,800	21,200	27,600	34,000	40,400	46,800	53,200
~180		8,000	16,000	23,100	30,100	37,200	44,200	51,200	58,300
~200		8,700	17,300	25,000	32,700	40,400	48,000	55,700	63,400
~220		9,300	18,600	26,900	35,200	43,600	51,900	60,200	68,500
~240		10,000	19,900	28,800	37,800	46,800	55,700	64,700	73,600
~260		10,600	21,200	30,800	40,400	50,000	59,600	69,200	78,800
~280		11,200	22,400	32,700	42,900	53,200	63,400	73,600	83,900
約1.5倍ヒダ		~56	~120	~200	~266	~333	~400	~466	~533

※片開きはW270cmまで

プライム縫製仕様価格表 約2倍ヒダ (タッセル含む)

H	W	~44 1巾(片開き)	~100 2巾	~150 3巾	~200 4巾	~250 5巾	~300 6巾	~350 7巾	~400 8巾
~100		5,800	11,500	16,200	21,000	25,800	30,500	35,300	40,000
~120		6,400	12,800	18,300	23,700	29,200	34,600	40,000	45,500
~140		7,100	14,200	20,300	26,400	32,600	38,700	44,800	50,900
~160		7,800	15,600	22,400	29,200	36,000	42,800	49,600	56,400
~180		8,500	16,900	24,400	31,900	39,400	46,800	54,300	61,800
~200		9,200	18,300	26,400	34,600	42,800	50,900	59,100	67,200
~220		9,800	19,600	28,500	37,300	46,200	55,000	63,800	72,700
~240		10,500	21,000	30,500	40,000	49,600	59,100	68,600	78,100
~260		11,200	22,400	32,600	42,800	53,000	63,200	73,400	83,600
~280		11,900	23,700	34,600	45,500	56,400	67,200	78,100	89,000
約1.5倍ヒダ		~56	~120	~200	~266	~333	~400	~466	~533

※片開きはW270cmまで

レギュラー縫製仕様価格表 約2倍ヒダ (タッセル含む)

H	W	~44 1巾(片開き)	~100 2巾	~150 3巾	~200 4巾	~250 5巾	~300 6巾	~350 7巾	~400 8巾
~100		5,200	10,400	14,600	18,800	23,000	27,200	31,400	35,600
~120		5,800	11,600	16,400	21,200	26,000	30,800	35,600	40,400
~140		6,400	12,800	18,200	23,600	29,000	34,400	39,800	45,200
~160		7,000	14,000	20,000	26,000	32,000	38,000	44,000	50,000
~180		7,600	15,200	21,800	28,400	35,000	41,600	48,200	54,800
~200		8,200	16,400	23,600	30,800	38,000	45,200	52,400	59,600
~220		8,800	17,600	25,400	33,200	41,000	48,800	56,600	64,400
~240		9,400	18,800	27,200	35,600	44,000	52,400	60,800	69,200
~260		10,000	20,000	29,000	38,000	47,000	56,000	65,000	74,000
~280		10,600	21,200	30,800	40,400	50,000	59,600	69,200	78,800
約1.5倍ヒダ		~56	~120	~200	~266	~333	~400	~466	~533
フラット前ヒダ		~80	~160	~260	~360	~460	~560		

形状記憶加工価格表 約2倍ヒダ (タッセル含む)

H	W	~44 1巾(片開き)	~100 2巾	~150 3巾	~200 4巾	~250 5巾	~300 6巾	~350 7巾	~400 8巾
~100		6,300	12,600	17,900	23,200	28,600	33,900	39,200	44,500
~120		7,100	14,100	20,200	26,300	32,400	38,400	44,500	50,600
~140		7,800	15,600	22,500	29,300	36,200	43,000	49,800	56,700
~160		8,600	17,200	24,800	32,400	40,000	47,600	55,200	62,800
~180		9,400	18,700	27,000	35,400	43,800	52,100	60,500	68,800
~200		10,100	20,200	29,300	38,400	47,600	56,700	65,800	74,900
~220		10,900	21,700	31,600	41,500	51,400	61,200	71,100	81,000
~240		11,600	23,200	33,900	44,500	55,200	65,800	76,400	87,100
~260		12,400	24,800	36,200	47,600	59,000	70,400	81,800	93,200

※片開きはW300cmまで

style no.60 プレーンシェード

コード式					ドラム式									
H	W	30~45	~90	~140	~190	~240	30~45	~90	~140	~190	~240	~290	~340	~390
50~100		12,000	16,000	22,500	26,500	33,000	15,000	19,000	25,500	29,500	36,000	43,200	49,900	54,700
~140		13,500	17,600	24,800	29,000	36,300	16,500	20,600	27,800	32,000	39,300	46,800	54,200	59,100
~180		14,900	19,100	27,200	31,400	39,600	17,900	22,100	30,200	34,400	42,600	50,100	58,200	63,300
~220		16,400	20,700	29,600	33,900	42,800	19,400	23,700	32,600	36,900	45,800	53,700	62,500	67,600
~260		17,900	22,300	32,000	36,300	46,100	20,900	25,300	35,000	39,300	49,100	57,000	66,800	71,800
~300		19,400	23,800	34,400	38,800	49,400	22,400	26,800	37,400	41,800	52,400	60,600	70,900	76,200

※ドラム式: 仕上り巾39cm以下の場合、仕上り丈は200cmまでとなります。

スリムシェード

コード式	
H	W
50~100	18~30
~140	16,800
~180	18,900
~220	20,400
~260	22,500
~240	23,800

style no.63 シャープシェード

コード式					ドラム式									
H	W	30~45	~90	~140	~190	~240	30~45	~90	~140	~190	~240	~290	~340	~390
50~100		14,700	20,900	29,500	36,100	44,400	17,700	23,900	32,500	39,100	47,400	55,600	64,100	70,700
~140		16,400	23,100	32,800	39,800	49,400	19,400	26,100	35,800	42,800	52,400	60,900	70,400	77,300
~180		18,000	25,200	36,000	43,500	54,300	21,000	28,200	39,000	46,500	57,300	66,200	77,000	84,300
~220		19,800	27,300	39,200	47,200	59,300	22,800	30,300	42,200	50,200	62,300	71,500	83,100	90,700
~260		21,500	29,700	42,900	51,500	64,900	24,500	32,700	45,900	54,500	67,900	77,600	90,300	98,500
~300		23,400	32,100	46,500	55,700	70,500	26,400	35,100	49,500	58,700	73,500	83,800	97,600	106,200

※ドラム式: 仕上り巾39cm以下の場合、仕上り丈は200cmまでとなります。

ハトメカーテン 約1.8倍ヒダ

38mm (片開き/タッセルなし)						
H	W	~72	~100	~127	~155	~183
~100		14,700	16,800	24,200	26,300	31,500
~140		16,500	18,600	26,800	28,900	35,100
~180		18,300	20,400	29,500	31,600	38,700
~220		20,100	22,200	32,200	34,300	42,200
~260		21,900	24,000	34,900	37,000	45,800
~300		23,700	25,800	37,600	39,700	49,400
26mm		-2,800	-2,100	-4,900	-4,200	-4,900
18mm		-4,900	-5,600	-9,100	-9,800	-10,500

※生地を伸ばした状態のサイズでご発注ください。

style no.S01 ロールソフト

スプリング・チェーンタイプ			
H	W	~80	~90
50~80		27,600	30,100
~120		29,300	32,400
~160		30,900	34,700
~200		33,700	38,900
~240		38,900	41,200

※丈は巾の3倍までが限度です。
※ロールソフト加工品は非防災品になります。

バランス

ストレートバランス						
H	W	~100	~150	~200	~250	~300
~40		10,600	15,700	20,800	25,900	31,100

※マジックテープ仕様・裏面スポンジ付の価格になります。
※ヨコ使いにて縫製した場合の価格になります。

三つ山・箱ヒダバランス (約2.5倍ヒダ)

H	W	~100	~150	~200	~250	~300
~40		7,200	9,700	12,200	16,700	19,200

※マジックテープ仕様の価格になります。

クッション

プレーン		パイピング	
サイズ	価格	サイズ	価格
40x40	5,400	40x40	6,000
45x45	6,800	45x45	7,400
フリル付			
サイズ	価格	サイズ	価格
40x40	7,800	40x40	7,600
45x45	9,300	45x45	9,200

※中材込みの価格になります。

遮光

TM-54304~54306



巾 ◇ 140 cm 価格 ◇ 8,950 円/m
組成 ◇ 表裏：ポリエステル100%
中間層：ポリウレタンラミネート100%

リピート ◇ タテ cm ヨコ cm
寸法変化率 ◇ 水洗い/タテ -0.2% ヨコ -0.3%
ドライ/タテ -1.0% ヨコ -0.8%

取扱表示 ◇ エ-17
防炎性能 ◇ (イ)
Made in Japan

標準仕様		ハイパー遮光縫製仕様価格表 約2倍ヒダ (タッセル含む)						
W	H	~62 1巾(片開き)	~140 2巾	~210 3巾	~280 4巾	~350 5巾	~420 6巾	~490 7巾
~100		19,000	37,700	54,200	70,500	87,100	103,600	119,900
~120		21,200	42,500	61,200	80,100	98,800	117,500	136,500
~140		23,500	47,000	68,400	89,500	110,600	131,700	152,800
~160		25,900	51,800	75,300	98,800	122,300	145,800	169,300
~180		28,300	56,600	82,300	108,200	134,100	160,000	185,900
~200		30,700	61,200	89,500	117,500	145,800	174,100	202,200
~220		32,900	66,000	96,400	127,100	157,600	188,000	218,700
~240		35,300	70,500	103,600	136,500	169,300	202,200	235,000
~260		37,700	75,300	110,600	145,800	181,100	216,300	251,600
~280		40,100	80,100	117,500	155,200	192,800	230,500	268,100
約1.5倍ヒダ		~78	~179	~277	~369	~466		

※片開きはW270cmまで
※かぶせ縫い+形態安定加工

サンカット		シャープシェードサンカット										
		コード式					ドラム式					
W	H	30~50	~90	~140	~190	~240	30~50	~90	~140	~190	~240	~290
50~100		44,300	52,300	61,900	79,700	93,700	47,300	55,300	64,900	82,700	96,700	117,600
~150		53,300	62,600	73,200	96,000	111,300	56,300	65,600	76,200	99,000	114,300	139,900
~200		62,400	72,900	84,400	112,300	128,900	65,400	75,900	87,400	115,300	131,900	162,400
~250		71,500	83,200	95,700	128,600	146,400	74,500	86,200	98,700	131,600	149,400	184,700
~300		80,600	93,500	107,000	145,000	164,000	83,600	96,500	110,000	148,000	167,000	207,100

※ドラム式：仕上り巾39cm以下の場合、仕上り丈は200cmまでとなります。(最大仕上り巾290cm)
※縫製の特性上、仕上り巾が131cm以上から生地をヨコ使いにて制作いたします。

TM-54307~54309



巾 ◇ 140 cm 価格 ◇ 9,800 円/m
組成 ◇ 表裏：ポリエステル100%
中間層：ポリウレタンラミネート100%

リピート ◇ タテ cm ヨコ cm
寸法変化率 ◇ 水洗い/タテ -0.8% ヨコ -0.5%
ドライ/タテ -0.5% ヨコ 0.0%

取扱表示 ◇ エ-17
防炎性能 ◇ (イ)
Made in Japan

標準仕様		ハイパー遮光縫製仕様価格表 約2倍ヒダ (タッセル含む)						
W	H	~62 1巾(片開き)	~140 2巾	~210 3巾	~280 4巾	~350 5巾	~420 6巾	~490 7巾
~100		20,300	40,400	58,100	75,600	93,400	111,100	128,600
~120		22,700	45,500	65,600	85,900	106,000	126,000	146,300
~140		25,200	50,400	73,300	95,900	118,600	141,200	163,800
~160		27,800	55,600	80,800	106,000	131,200	156,400	181,600
~180		30,400	60,700	88,200	116,000	143,800	171,500	199,300
~200		32,900	65,600	95,900	126,000	156,400	186,700	216,800
~220		35,300	70,700	103,400	136,300	169,000	201,600	234,500
~240		37,800	75,600	111,100	146,300	181,600	216,800	252,000
~260		40,400	80,800	118,600	156,400	194,200	232,000	269,800
~280		43,000	85,900	126,000	166,400	206,800	247,100	287,500
約1.5倍ヒダ		~78	~179	~277	~369	~466		

※片開きはW270cmまで
※かぶせ縫い+形態安定加工

サンカット		シャープシェードサンカット										
		コード式					ドラム式					
W	H	30~50	~90	~140	~190	~240	30~50	~90	~140	~190	~240	~290
50~100		45,600	53,800	63,700	82,600	97,100	48,600	56,800	66,700	85,600	100,100	122,100
~150		54,900	64,400	75,300	99,700	115,300	57,900	67,400	78,300	102,700	118,300	145,500
~200		64,300	75,000	87,000	116,600	133,500	67,300	78,000	90,000	119,600	136,500	168,900
~250		73,700	85,800	98,600	133,700	151,800	76,700	88,800	101,600	136,700	154,800	192,300
~300		83,100	96,400	110,200	150,700	170,000	86,100	99,400	113,200	153,700	173,000	215,600

※ドラム式：仕上り巾39cm以下の場合、仕上り丈は200cmまでとなります。(最大仕上り巾290cm)
※縫製の特性上、仕上り巾が131cm以上から生地をヨコ使いにて制作いたします。

標準仕様		ハイパー遮光形状記憶加工価格表 約2倍ヒダ (タッセル含む)							
W	H	~62 1巾(片開き)	~140 2巾	~210 3巾	~280 4巾	~350 5巾	~420 6巾	~490 7巾	~560 8巾
~100		20,000	39,600	57,200	74,400	92,000	109,500	126,800	144,300
~120		22,300	44,700	64,500	84,600	104,400	124,200	144,300	164,100
~140		24,800	49,500	72,200	94,500	116,900	139,200	161,600	184,200
~160		27,300	54,600	79,500	104,400	129,300	154,200	179,100	204,000
~180		29,900	59,700	86,900	114,300	141,800	169,200	196,700	223,800
~200		32,400	64,500	94,500	124,200	154,200	184,200	213,900	243,900
~220		34,700	69,600	101,900	134,400	166,700	198,900	231,500	263,700
~240		37,200	74,400	109,500	144,300	179,100	213,900	248,700	283,800
~260		39,800	79,500	116,900	154,200	191,600	228,900	266,300	303,600

※片開きはW300cmまで
※かぶせ縫い+形状記憶加工

TM-54310・54311



巾 ◇ 150cm 価格 ◇ 8,500円/m リポート ◇ タテ cm ヨコ cm
 組成 ◇ ポリエステル100% 寸法変化率 ◇ 水洗い/タテ -0.5% ヨコ 0.0%
 裏面：アクリル樹脂・アルミコーティング100% ドライ/タテ -0.5% ヨコ 0.0%

取扱い表示 ◇ エ-17
 防炎性能 ◇ (口)
 Made in Japan

標準仕様		バックコーティング縫製仕様価格表 約2倍ヒダ (タッセル含む)							
H	W	~67 1巾(片開き)	~150 2巾	~225 3巾	~300 4巾	~375 5巾	~450 6巾	~525 7巾	~600 8巾
~100		18,400	36,800	52,900	69,000	85,100	101,200	117,300	133,400
~120		20,700	41,400	59,800	78,200	96,600	115,000	133,400	151,800
~140		23,000	46,000	66,700	87,400	108,100	128,800	149,500	170,200
~160		25,300	50,600	73,600	96,600	119,600	142,600	165,600	188,600
~180		27,600	55,200	80,500	105,800	131,100	156,400	181,700	207,000
~200		29,900	59,800	87,400	115,000	142,600	170,200	197,800	225,400
~220		32,200	64,400	94,300	124,200	154,100	184,000	213,900	243,800
~240		34,500	69,000	101,200	133,400	165,600	197,800	230,000	262,200
~260		36,800	73,600	108,100	142,600	177,100	211,600	246,100	280,600
~280		39,100	78,200	115,000	151,800	188,600	225,400	262,200	299,000
約1.5倍ヒダ		~88	~193	~295	~398	~500	~600	~700	~800
フラット約1倍ヒダ		~130	~260	~410	~560				

サンカット		シャープシェードサンカット					
		コード式			ドラム式		
H	W	30~50	~90	~140	30~50	~90	~140
50~100		43,700	51,500	60,900	46,700	54,500	63,900
~150		52,500	61,600	72,000	55,500	64,600	75,000
~200		61,400	71,700	83,100	64,400	74,700	86,100
~250		70,300	81,900	94,200	73,300	84,900	97,200
~300		79,200	92,000	105,300	82,200	95,000	108,300

※ドラム式：仕上り巾39cm以下の場合
仕上り丈は200cmまでとなります。(最大仕上り巾140cm)

TM-54312~54314



巾 ◇ 150cm 価格 ◇ 8,850円/m リポート ◇ タテ 22.3 cm ヨコ 12.5 cm
 組成 ◇ ポリエステル100% 寸法変化率 ◇ 水洗い/タテ -0.1% ヨコ 0.0%
 裏面：アクリル樹脂・アルミコーティング100% ドライ/タテ -1.0% ヨコ -0.3%

取扱い表示 ◇ エ-17
 防炎性能 ◇ (口)
 Made in Japan

標準仕様		バックコーティング縫製仕様価格表 約2倍ヒダ (タッセル含む)							
H	W	~67 1巾(片開き)	~150 2巾	~225 3巾	~300 4巾	~375 5巾	~450 6巾	~525 7巾	~600 8巾
~100		21,400	42,700	60,600	79,500	97,200	116,200	135,100	153,000
~120		23,700	47,400	68,800	90,100	111,400	131,700	153,000	174,300
~140		23,700	47,400	68,800	90,100	111,400	131,700	153,000	174,300
~160		26,100	53,500	77,200	100,900	124,600	148,300	172,000	195,700
~180		29,800	58,200	84,300	111,400	137,500	163,600	190,900	217,000
~200		32,100	63,000	92,500	122,200	150,600	180,200	208,600	238,300
~220		34,500	68,800	100,900	131,700	163,600	195,700	227,600	258,400
~240		36,900	73,500	108,000	142,200	176,700	211,000	245,400	279,700
~260		40,300	79,500	116,200	153,000	190,900	227,600	264,400	301,000
~280		42,700	84,300	124,600	163,600	203,900	243,100	283,400	322,400
約1.5倍ヒダ		~88	~193	~295	~398	~500	~600	~700	~800
フラット約1倍ヒダ		~130	~260	~410	~560				

サンカット		シャープシェードサンカット					
		コード式			ドラム式		
H	W	30~50	~90	~140	30~50	~90	~140
50~100		45,600	53,500	63,100	48,600	56,500	66,100
~150		53,800	63,100	73,600	56,800	66,100	76,600
~200		62,900	73,300	84,900	65,900	76,300	87,900
~250		72,600	84,400	96,800	75,600	87,400	99,800
~300		81,700	94,600	108,000	84,700	97,600	111,000

※ドラム式：仕上り巾39cm以下の場合
仕上り丈は200cmまでとなります。(最大仕上り巾140cm)

遮光

TM-54318

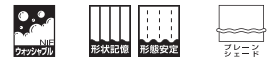

巾 ◇ 300cm ヨコ使い 価格 ◇ 10,400円/m リポート ◇ タテ 300.0cm ヨコ 90.0cm 取り扱い表示 ◇ リ-30 30 40 50 60 70 80 90 100 110 120 130 140 150 160 170 180 190 200 210 220 230 240 250 260 270 280 290 300 310 320 330 340 350 360 370 380 390 400 410 420 430 440 450 460 470 480 490 500 510 520 530 540 550 560 570 580 590 600 610 620 630 640 650 660 670 680 690 700 710 720 730 740 750 760 770 780 790 800 810 820 830 840 850 860 870 880 890 900 910 920 930 940 950 960 970 980 990 1000 1010 1020 1030 1040 1050 1060 1070 1080 1090 1100 1110 1120 1130 1140 1150 1160 1170 1180 1190 1200 1210 1220 1230 1240 1250 1260 1270 1280 1290 1300 1310 1320 1330 1340 1350 1360 1370 1380 1390 1400 1410 1420 1430 1440 1450 1460 1470 1480 1490 1500 1510 1520 1530 1540 1550 1560 1570 1580 1590 1600 1610 1620 1630 1640 1650 1660 1670 1680 1690 1700 1710 1720 1730 1740 1750 1760 1770 1780 1790 1800 1810 1820 1830 1840 1850 1860 1870 1880 1890 1900 1910 1920 1930 1940 1950 1960 1970 1980 1990 2000 2010 2020 2030 2040 2050 2060 2070 2080 2090 2100 2110 2120 2130 2140 2150 2160 2170 2180 2190 2200 2210 2220 2230 2240 2250 2260 2270 2280 2290 2300 2310 2320 2330 2340 2350 2360 2370 2380 2390 2400 2410 2420 2430 2440 2450 2460 2470 2480 2490 2500 2510 2520 2530 2540 2550 2560 2570 2580 2590 2600 2610 2620 2630 2640 2650 2660 2670 2680 2690 2700 2710 2720 2730 2740 2750 2760 2770 2780 2790 2800 2810 2820 2830 2840 2850 2860 2870 2880 2890 2900 2910 2920 2930 2940 2950 2960 2970 2980 2990 3000 3010 3020 3030 3040 3050 3060 3070 3080 3090 3100 3110 3120 3130 3140 3150 3160 3170 3180 3190 3200 3210 3220 3230 3240 3250 3260 3270 3280 3290 3300 3310 3320 3330 3340 3350 3360 3370 3380 3390 3400 3410 3420 3430 3440 3450 3460 3470 3480 3490 3500 3510 3520 3530 3540 3550 3560 3570 3580 3590 3600 3610 3620 3630 3640 3650 3660 3670 3680 3690 3700 3710 3720 3730 3740 3750 3760 3770 3780 3790 3800 3810 3820 3830 3840 3850 3860 3870 3880 3890 3900 3910 3920 3930 3940 3950 3960 3970 3980 3990 4000 4010 4020 4030 4040 4050 4060 4070 4080 4090 4100 4110 4120 4130 4140 4150 4160 4170 4180 4190 4200 4210 4220 4230 4240 4250 4260 4270 4280 4290 4300 4310 4320 4330 4340 4350 4360 4370 4380 4390 4400 4410 4420 4430 4440 4450 4460 4470 4480 4490 4500 4510 4520 4530 4540 4550 4560 4570 4580 4590 4600 4610 4620 4630 4640 4650 4660 4670 4680 4690 4700 4710 4720 4730 4740 4750 4760 4770 4780 4790 4800 4810 4820 4830 4840 4850 4860 4870 4880 4890 4900 4910 4920 4930 4940 4950 4960 4970 4980 4990 5000 5010 5020 5030 5040 5050 5060 5070 5080 5090 5100 5110 5120 5130 5140 5150 5160 5170 5180 5190 5200 5210 5220 5230 5240 5250 5260 5270 5280 5290 5300 5310 5320 5330 5340 5350 5360 5370 5380 5390 5400 5410 5420 5430 5440 5450 5460 5470 5480 5490 5500 5510 5520 5530 5540 5550 5560 5570 5580 5590 5600 5610 5620 5630 5640 5650 5660 5670 5680 5690 5700 5710 5720 5730 5740 5750 5760 5770 5780 5790 5800 5810 5820 5830 5840 5850 5860 5870 5880 5890 5900 5910 5920 5930 5940 5950 5960 5970 5980 5990 6000 6010 6020 6030 6040 6050 6060 6070 6080 6090 6100 6110 6120 6130 6140 6150 6160 6170 6180 6190 6200 6210 6220 6230 6240 6250 6260 6270 6280 6290 6300 6310 6320 6330 6340 6350 6360 6370 6380 6390 6400 6410 6420 6430 6440 6450 6460 6470 6480 6490 6500 6510 6520 6530 6540 6550 6560 6570 6580 6590 6600 6610 6620 6630 6640 6650 6660 6670 6680 6690 6700 6710 6720 6730 6740 6750 6760 6770 6780 6790 6800 6810 6820 6830 6840 6850 6860 6870 6880 6890 6900 6910 6920 6930 6940 6950 6960 6970 6980 6990 7000 7010 7020 7030 7040 7050 7060 7070 7080 7090 7100 7110 7120 7130 7140 7150 7160 7170 7180 7190 7200 7210 7220 7230 7240 7250 7260 7270 7280 7290 7300 7310 7320 7330 7340 7350 7360 7370 7380 7390 7400 7410 7420 7430 7440 7450 7460 7470 7480 7490 7500 7510 7520 7530 7540 7550 7560 7570 7580 7590 7600 7610 7620 7630 7640 7650 7660 7670 7680 7690 7700 7710 7720 7730 7740 7750 7760 7770 7780 7790 7800 7810 7820 7830 7840 7850 7860 7870 7880 7890 7900 7910 7920 7930 7940 7950 7960 7970 7980 7990 8000 8010 8020 8030 8040 8050 8060 8070 8080 8090 8100 8110 8120 8130 8140 8150 8160 8170 8180 8190 8200 8210 8220 8230 8240 8250 8260 8270 8280 8290 8300 8310 8320 8330 8340 8350 8360 8370 8380 8390 8400 8410 8420 8430 8440 8450 8460 8470 8480 8490 8500 8510 8520 8530 8540 8550 8560 8570 8580 8590 8600 8610 8620 8630 8640 8650 8660 8670 8680 8690 8700 8710 8720 8730 8740 8750 8760 8770 8780 8790 8800 8810 8820 8830 8840 8850 8860 8870 8880 8890 8900 8910 8920 8930 8940 8950 8960 8970 8980 8990 9000 9010 9020 9030 9040 9050 9060 9070 9080 9090 9100 9110 9120 9130 9140 9150 9160 9170 9180 9190 9200 9210 9220 9230 9240 9250 9260 9270 9280 9290 9300 9310 9320 9330 9340 9350 9360 9370 9380 9390 9400 9410 9420 9430 9440 9450 9460 9470 9480 9490 9500 9510 9520 9530 9540 9550 9560 9570 9580 9590 9600 9610 9620 9630 9640 9650 9660 9670 9680 9690 9700 9710 9720 9730 9740 9750 9760 9770 9780 9790 9800 9810 9820 9830 9840 9850 9860 9870 9880 9890 9900 9910 9920 9930 9940 9950 9960 9970 9980 9990 10000 10010 10020 10030 10040 10050 10060 10070 10080 10090 10100 10110 10120 10130 10140 10150 10160 10170 10180 10190 10200 10210 10220 10230 10240 10250 10260 10270 10280 10290 10300 10310 10320 10330 10340 10350 10360 10370 10380 10390 10400 10410 10420 10430 10440 10450 10460 10470 10480 10490 10500 10510 10520 10530 10540 10550 10560 10570 10580 10590 10600 10610 10620 10630 10640 10650 10660 10670 10680 10690 10700 10710 10720 10730 10740 10750 10760 10770 10780 10790 10800 10810 10820 10830 10840 10850 10860 10870 10880 10890 10900 10910 10920 10930 10940 10950 10960 10970 10980 10990 11000 11010 11020 11030 11040 11050 11060 11070 11080 11090 11100 11110 11120 11130 11140 11150 11160 11170 11180 11190 11200 11210 11220 11230 11240 11250 11260 11270 11280 11290 11300 11310 11320 11330 11340 11350 11360 11370 11380 11390 11400 11410 11420 11430 11440 11450 11460 11470 11480 11490 11500 11510 11520 11530 11540 11550 11560 11570 11580 11590 11600 11610 11620 11630 11640 11650 11660 11670 11680 11690 11700 11710 11720 11730 11740 11750 11760 11770 11780 11790 11800 11810 11820 11830 11840 11850 11860 11870 11880 11890 11900 11910 11920 11930 11940 11950 11960 11970 11980 11990 12000 12010 12020 12030 12040 12050 12060 12070 12080 12090 12100 12110 12120 12130 12140 12150 12160 12170 12180 12190 12200 12210 12220 12230 12240 12250 12260 12270 12280 12290 12300 12310 12320 12330 12340 12350 12360 12370 12380 12390 12400 12410 12420 12430 12440 12450 12460 12470 12480 12490 12500 12510 12520 12530 12540 12550 12560 12570 12580 12590 12600 12610 12620 12630 12640 12650 12660 12670 12680 12690 12700 12710 12720 12730 12740 12750 12760 12770 12780 12790 12800 12810 12820 12830 12840 12850 12860 12870 12880 12890 12900 12910 12920 12930 12940 12950 12960 12970 12980 12990 13000 13010 13020 13030 13040 13050 13060 13070 13080 13090 13100 13110 13120 13130 13140 13150 13160 13170 13180 13190 13200 13210 13220 13230 13240 13250 13260 13270 13280 13290 13300 13310 13320 13330 13340 13350 13360 13370 13380 13390 13400 13410 13420 13430 13440 13450 13460 13470 13480 13490 13500 13510 13520 13530 13540 13550 13560 13570 13580 13590 13600 13610 13620 13630 13640 13650 13660 13670 13680 13690 13700 13710 13720 13730 13740 13750 13760 13770 13780 13790 13800 13810 13820 13830 13840 13850 13860 13870 13880 13890 13900 13910 13920 13930 13940 13950 13960 13970 13980 13990 14000 14010 14020 14030 14040 14050 14060 14070 14080 14090 14100 14110 14120 14130 14140 14150 14160 14170 14180 14190 14200 14210 14220 14230 14240 14250 14260 14270 14280 14290 14300 14310 14320 14330 14340 14350 14360 14370 14380 14390 14400 14410 14420 14430 14440 14450 14460 14470 14480 14490 14500 14510 14520 14530 14540 14550 14560 14570 14580 14590 14600 14610 14620 14630 14640 14650 14660 14670 14680 14690 14700 14710 14720 14730 14740 14750 14760 14770 14780 14790 14800 14810 14820 14830 14840 14850 14860 14870 14880 14890 14900 14910 14920 14930 14940 14950 14960 14970 14980 14990 15000 15010 15020 15030 15040 15050 15060 15070 15080 15090 15100 15110 15120 15130 15140 15150 15160 15170 15180 15190 15200 15210 15220 15230 15240 15250 15260 15270 15280 15290 15300 15310 15320 15330 15340 15350 15360 15370 15380 15390 15400 15410 15420 15430 15440 15450 15460 15470 15480 15490 15500 15510 15520 15530 15540 15550 15560 15570 15580 15590 15600 15610 15620 15630 15640 15650 15660 15670 15680 15690 15700 15710 15720 15730 15740 15750 15760 15770 15780 15790 15800 15810 15820 15830 15840 15850 15860 15870 15880 15890 15900 15910 15920 15930 15940 15950 15960 15970 15980 15990 16000 16010 16020 16030 16040 16050 16060 16070 16080 16090 16100 16110 16120 16130 16140 16150 16160 16170 16180 16190 16200 16210 16220 16230 16240 16250 16260 16270 16280 16290 16300 16310 16320 16330 16340 16350 16360 16370 16380 16390 16400 16410 16420 16430 16440 16450 16460 16470 16480 16490 16500 16510 16520 16530 16540 16550 16560 16570 16580 16590 16600 16610 16620 16630 16640 16650 16660 16670 16680 16690 16700 16710 16720 16730 16740 16750 16760 16770 16780 16790 16800 16810 16820 16830 16840 16850 16860 16870 16880 16890 16900 16910 16920 16930 16940 16950 16960 16970 16980 16990 17000 17010 17020 17030 17040 17050 17060 17070 17080 17090 17100 17110 17120 17130 17140 17150 17160 17170 17180 17190 17200 17210 17220 17230 17240 17250 17260 17270 17280 17290 17300 17310 17320 17330 17340 17350 17360 17370 17380 17390 17400 17410 17420 17430 17440 17450 17460 17470 17480 17490 17500 17510 17520 17530 17540 17550 17560 17570 17580 17590 17600 17610 17620 17630 17640 17650 17660 17670 17680 17690 17700 17710 17720 17730 17740 17750 17760 17770 17780 17790 17800 17810 17820 17830 17840 17850 17860 17870 17880 17890 17900 17910 17920 17930 17940 17950 17960 17970 17980 17990 18000 18010 18020 18030 18040 18050 18060 18070 18080 18090 18100 18110 18120 18130 18140 18150 18160 18170 18180 18190 18200 18210 18220 18230 18240 18250 18260 18270 18280 18290 18300 18310 18320 18330 18340 18350 18360 18370 18380 18390 18400 18410 18420 18430 18440 18450 18460 18470 18480 18490 18500 18510 18520 18530 18540 18550 18560 18570 18580 18590 18600 18610 18620 18630 18640 18650 18660 18670 18680 18690 18700 18710 18720 18730 18740 18750 18760 18770 18780 18790 18800 18810 18820 18830 18840 18850 18860 18870 18880 18890 18900 18910 18920 18930 18940 18950 18960 18970 18980 18990 19000 19010 19020 19030 19040 19050 19060 19070 19080 19090 19100 19110 19120 19130 19140 19150 19160 19170 19180 19190 19200 19210 19220 19230 19240 19250 19260 19270 19280 19290 19300 19310 19320 19330 19340 19350 19360 19370 19380 19390 19400 19410 19420 19430 19440 19450 19460 19470 19480 19490 19500 19510 19520 19530 19540 19550 19560 19570 19580 19590 19600 19610 19620 19630 19640 19650 19660 19670 19680 19690 19700 19710 19720 19730 19740 19750 19760 19770 19780 19790 19800 19810 19820 19830 19840 19850 19860 19870 19880 19890 19900 19910 19920 19930 19940 19950 19960 19970 19980 19990 20000 20010 20020 20030 20040 20050 20060 20070 20080 20090 20100 20110 20120 20130 20140 20150 20160 20170 20180 20190 20200 20210 20220 20230 20240 20250 20260 20270 20280 20290 20300 20310 20320 20330 20340 20350 20360 20370 20380 20390 20400 20410 20420 20430 20440 20450 20460 20470 20480 20490 20500 20510 20520 20530 20540 20550 20560 20570 20580 20590 20600 20610 20620 20630 20640 20650 20660 20670 20680 20690 20700 20710 20720 20730 20740 20750 20760 20770 20780 20790 20800 20810 20820 20830 20840 20850 20860 20870 20880 20890 20900 20910 20920 20930 20940 20950 20960 20970 20980 20990 21000 21010 21020 21030 21040 21050 21060 21070 21080 21090 21100 21110 21120 21130 21140 21150 21160 21170 21180 21190 21200 21210 21220 21230 21240 21250 21260 21270 21280 21290 21300 21310 21320 21330 21340 21350 21360 21370 21380 21390 21400 21410 21420 21430 21440 21450 21460 21470 21480 21490 21500 21510 21520 21530 21540 21550 21560 21570 21580 21590 21600 21610 21620 21630 21640 21650 21660 21670 21680 21690 21700 21710 21720 21730 21740 21750 21760 21770 21780 21790 21800 21810 21820 21830 21840 21850 21860 21870 21880 21890 21900 21910 21920 21930 21940 21950 21960 21970 21980 21990 22000 22010 22020 22030 22040 22050 22060 22070 22080 22090 22100 22110 22120 22130

TM-54319



巾 ◇ 300 cm ヨコ使い 価格 ◇ 13,800 円/m リポート ◇ タテ 58.0 cm ヨコ 65.0 cm 取扱い表示 ◇ リ-30 40 40 1 1 F W
 組成 ◇ ポリエステル100% 寸法変化率 ◇ 水洗い/タテ -0.3% ヨコ -0.2% 防炎性能 ◇ - あて布使用
 ドライ/タテ 0.0% ヨコ -0.5% Made in Turkey

標準仕様		レギュラー縫製仕様価格表 約2倍ヒダ (タッセルなし)							
W	H	~50 (片開き)	~100	~150	~200	~250	~300	~350	~400
~100	~100	17,000	32,500	48,000	63,500	78,900	94,400	109,900	125,400
~120	~120	17,400	33,100	48,800	64,500	80,300	96,000	111,700	127,400
~140	~140	17,600	33,600	49,500	65,500	81,500	97,400	113,400	129,300
~160	~160	17,900	34,100	50,300	66,500	82,700	98,900	115,100	131,300
~180	~180	18,100	34,500	51,000	67,400	83,900	100,300	116,700	133,200
~200	~200	18,300	35,000	51,700	68,400	85,100	101,700	118,400	135,100
~220	~220	18,700	35,600	52,500	69,500	86,400	103,300	120,200	137,100
~240	~240	18,900	36,100	53,300	70,400	87,600	104,700	121,900	139,100
~260	~260	19,200	36,600	54,000	71,400	88,800	106,200	123,600	141,000
約1.5倍ヒダ	~60	~120	~200	~266	~333	~400	~466	~533	
フラット前ヒダ	~90	~160	~260	~360	~460	~560			

TM-54320



巾 ◇ 300 cm ヨコ使い 価格 ◇ 12,000 円/m リポート ◇ タテ - cm ヨコ 6.0 cm 取扱い表示 ◇ リ-30 40 40 1 1 F W
 組成 ◇ ポリエステル100% 寸法変化率 ◇ 水洗い/タテ 0.3% ヨコ 0.0% 防炎性能 ◇ - あて布使用
 ドライ/タテ -0.2% ヨコ -2.8% Made in Turkey

標準仕様		レギュラー縫製仕様価格表 約2倍ヒダ (タッセルなし)							
W	H	~50 (片開き)	~100	~150	~200	~250	~300	~350	~400
~100	~100	15,000	28,700	42,400	56,100	69,800	83,400	97,100	110,800
~120	~120	15,400	29,300	43,200	57,200	71,100	85,000	98,900	112,800
~140	~140	15,600	29,800	44,000	58,100	72,300	86,400	100,600	114,800
~160	~160	15,900	30,300	44,700	59,100	73,500	87,900	102,300	116,700
~180	~180	16,100	30,800	45,400	60,000	74,700	89,300	104,000	118,600
~200	~200	16,400	31,200	46,100	61,000	75,900	90,800	105,600	120,500
~220	~220	16,700	31,800	47,000	62,100	77,200	92,300	107,400	122,600
~240	~240	17,000	32,300	47,700	63,000	78,400	93,800	109,100	124,500
~260	~260	17,200	32,800	48,400	64,000	79,600	95,200	110,800	126,400
約1.5倍ヒダ	~60	~120	~200	~266	~333	~400	~466	~533	
フラット前ヒダ	~90	~160	~260	~360	~460	~560			

レース

TM-54321



巾 ◇ 290cm ヨコ使い 価格 ◇ 14,500円/m リポート ◇ タテ 290.0cm ヨコ 21.5cm 取扱い表示 ◇ リ-30
 組成 ◇ ポリエステル100% 寸法変化率 ◇ 水洗い/タテ -0.2% ヨコ 0.0% 防炎性能 ◇ -
 ドライ/タテ -0.2% ヨコ 0.0% Made in Turkey

標準仕様		レギュラー縫製仕様価格表 約2倍ヒダ (タッセルなし)							
H	W	~50 (片開き)	~100	~150	~200	~250	~300	~350	~400
~100		17,800	34,000	50,200	66,300	82,500	98,700	114,900	131,100
~120		18,200	34,600	51,000	67,400	83,800	100,300	116,700	133,100
~140		18,400	35,100	51,700	68,400	85,000	101,700	118,400	135,000
~160		18,600	35,500	52,400	69,300	86,200	103,100	120,000	136,900
~180		18,900	36,000	53,200	70,300	87,400	104,600	121,700	138,900
~200		19,100	36,500	53,900	71,300	88,600	106,000	123,400	140,800
~220		19,500	37,100	54,700	72,300	90,000	107,600	125,200	142,800
~240		19,700	37,600	55,400	73,300	91,200	109,000	126,900	144,700
~260		19,800	37,800	55,800	73,800	91,800	109,700	127,700	145,700
~270		19,800	37,800	55,800	73,800	91,800	109,700	127,700	145,700
約1.5倍ヒダ		~60	~120	~200	~266	~333	~400	~466	~533
フラット耐1倍ヒダ		~90	~160	~260	~360	~460	~560		

形状記憶加工価格表 約2倍ヒダ (タッセルなし)									
H	W	~50 (片開き)	~100	~150	~200	~250	~300	~350	~400
~100		19,000	36,300	53,600	70,900	88,200	105,500	122,800	140,100
~120		19,600	37,300	55,000	72,700	90,400	108,100	125,800	143,500
~140		20,000	38,100	56,200	74,300	92,400	110,500	128,600	146,700
~160		20,400	38,900	57,400	75,900	94,400	112,900	131,400	149,900
~180		20,800	39,700	58,600	77,500	96,400	115,300	134,200	153,100
~200		21,200	40,500	59,800	79,100	98,400	117,700	137,000	156,300
~220		21,800	41,500	61,200	80,900	100,600	120,300	140,000	159,700
~240		22,200	42,300	62,400	82,500	102,600	122,700	142,800	162,900
~260		22,400	42,700	63,000	83,300	103,600	123,900	144,200	164,500

※片開きはW300cmまで

style no.60 プレーンシェード											
		コード式					ドラム式				
H	W	30~45	~90	~140	~190	~240	30~45	~90	~140	~190	~240
50~100		47,100	50,300	54,900	58,200	62,900	50,100	53,300	57,900	61,200	65,900
~140		47,900	51,300	56,100	59,500	64,400	50,900	54,300	59,100	62,500	67,400
~180		48,800	52,200	57,200	60,700	65,800	51,800	55,200	60,200	63,700	68,800
~220		49,600	53,200	58,400	61,900	67,300	52,600	56,200	61,400	64,900	70,300
~260		50,400	54,100	59,500	63,200	68,700	53,400	57,100	62,500	66,200	71,700
~270		88,300	91,200	96,800	99,700	105,500	91,300	94,200	99,800	102,700	108,500

※ドラム式：仕上り巾39cm以下の場合、仕上り丈は200cmまでとなります。

スリムシェード		
		コード式
H	W	18~30
50~100		48,700
~140		50,200
~180		51,200
~220		52,700
~240		53,700

エンブroidアリー							
style no.30 (両開き/タッセル含む)							
H	W	~100	~150	~200	~250	~300	~350
~270		35,000	52,400	69,800	87,300	104,600	122,100

TM-54322



巾 ◇ 270 cm ヨコ使い 価格 ◇ 12,400 円/m リピート ◇ タテ 270.0 cm ヨコ 5.5 cm 取扱表示 ◇ リ-30 40 洗濯機 漂白剤 熨斗 乾燥機 防炎性能 ◇ -
 組成 ◇ ポリエステル100% 寸法変化率 ◇ 水洗い/タテ 0.0% ヨコ 0.0% 防炎性能 ◇ -
 ドライ/タテ 0.0% ヨコ -0.5% Made in Turkey

標準仕様		レギュラー縫製仕様価格表 約2倍ヒダ (タッセルなし)							
H	W	~50 (片開き)	~100	~150	~200	~250	~300	~350	~400
~100		15,500	29,600	43,600	57,700	71,800	85,900	100,000	114,000
~120		15,800	30,200	44,500	58,800	73,100	87,400	101,800	116,100
~140		16,100	30,600	45,200	59,800	74,300	88,900	103,400	118,000
~160		16,300	31,100	45,900	60,700	75,500	90,300	105,100	119,900
~180		16,600	31,600	46,600	61,700	76,700	91,800	106,800	121,800
~200		16,800	32,100	47,400	62,600	77,900	93,200	108,500	123,800
~220		17,200	32,700	48,200	63,700	79,200	94,800	110,300	125,800
~240		17,300	32,900	48,600	64,200	79,800	95,500	111,100	126,800
~250		17,300	32,900	48,600	64,200	79,800	95,500	111,100	126,800
約1.5倍ヒダ		~60	~120	~200	~266	~333	~400	~466	~533
フラット前ヒダ		~90	~160	~260	~360	~460	~560		

形状記憶加工価格表 約2倍ヒダ (タッセルなし)									
H	W	~50 (片開き)	~100	~150	~200	~250	~300	~350	~400
~100		16,700	31,900	47,100	62,300	77,500	92,700	107,900	123,100
~120		17,300	32,900	48,500	64,100	79,700	95,300	110,900	126,500
~140		17,700	33,700	49,700	65,700	81,700	97,700	113,700	129,700
~160		18,100	34,500	50,900	67,300	83,700	100,100	116,500	132,900
~180		18,500	35,300	52,100	68,900	85,700	102,500	119,300	136,100
~200		18,900	36,100	53,300	70,500	87,700	104,900	122,100	139,300
~220		19,500	37,100	54,700	72,300	89,900	107,500	125,100	142,700
~240		19,700	37,500	55,300	73,100	90,900	108,700	126,500	144,300
~250		19,700	37,500	55,300	73,100	90,900	108,700	126,500	144,300

※片開きはW300cmまで

エンブroidアリー

style no.30 (両開き/タッセル含む)							
H	W	~100	~150	~200	~250	~300	~350
~250		30,400	45,600	60,600	75,800	90,900	106,100

TM-54323



巾 ◇ 285 cm ヨコ使い 価格 ◇ 13,400 円/m リピート ◇ タテ 285.0 cm ヨコ 16.0 cm 取扱表示 ◇ リ-30 40 洗濯機 漂白剤 熨斗 乾燥機 防炎性能 ◇ -
 組成 ◇ ポリエステル100% 寸法変化率 ◇ 水洗い/タテ 0.0% ヨコ 0.0% 防炎性能 ◇ -
 ドライ/タテ 0.0% ヨコ 0.0% Made in Turkey

標準仕様		レギュラー縫製仕様価格表 約2倍ヒダ (タッセルなし)							
H	W	~50 (片開き)	~100	~150	~200	~250	~300	~350	~400
~100		16,600	31,700	46,700	61,800	76,900	92,000	107,100	122,100
~120		16,900	32,300	47,600	62,900	78,200	93,500	108,900	124,200
~140		17,200	32,700	48,300	63,900	79,400	95,000	110,500	126,100
~160		17,400	33,200	49,000	64,800	80,600	96,400	112,200	128,000
~180		17,700	33,700	49,700	65,800	81,800	97,900	113,900	129,900
~200		17,900	34,200	50,500	66,700	83,000	99,300	115,600	131,900
~220		18,300	34,800	51,300	67,800	84,300	100,900	117,400	133,900
~240		18,500	35,300	52,000	68,800	85,500	102,300	119,100	135,800
~260		18,500	35,400	52,100	69,000	85,800	102,700	119,400	136,300
~265		18,500	35,400	52,100	69,000	85,800	102,700	119,400	136,300
約1.5倍ヒダ		~60	~120	~200	~266	~333	~400	~466	~533
フラット前ヒダ		~90	~160	~260	~360	~460	~560		

エンブroidアリー

style no.30 (両開き/タッセル含む)							
H	W	~100	~150	~200	~250	~300	~350
~265		32,600	48,800	65,000	81,300	97,400	113,700

TM-54325・54326



巾 ◇ 150cm 価格 ◇ 6,000円/m
 組成 ◇ ポリエステル100%

リポート ◇ タテ 58.5cm ヨコ 50.0cm
 寸法変化率 ◇ 水洗い/タテ 0.2% ヨコ -0.7%
 ドライ/タテ -0.2% ヨコ -0.2%

取扱い表示 ◇ リ-30
 防炎性能 ◇ (イ)
 Made in Japan

H	W	~67	~150	~225	~300	~375	~450	~525	~600
		1巾(片開き)	2巾	3巾	4巾	5巾	6巾	7巾	8巾
~100		14,100	28,100	41,400	55,500	68,700	82,700	96,000	110,100
~120		14,100	28,100	41,400	55,500	68,700	82,700	96,000	110,100
~140		14,100	28,100	41,400	55,500	68,700	82,700	96,000	110,100
~160		18,800	36,800	55,500	73,400	91,400	110,100	128,000	146,700
~180		18,800	36,800	55,500	73,400	91,400	110,100	128,000	146,700
~200		23,400	46,100	68,700	91,400	114,800	137,300	160,000	182,600
~220		23,400	46,100	68,700	91,400	114,800	137,300	160,000	182,600
~240		23,400	46,100	68,700	91,400	114,800	137,300	160,000	182,600
~260		28,100	55,500	82,700	110,100	137,300	164,700	191,900	219,300
~280		28,100	55,500	82,700	110,100	137,300	164,700	191,900	219,300
約1.5倍ヒダ		~88	~200	~300	~400	~500	~600	~700	~800
フラット約1倍ヒダ		~130	~260	~410	~560				

H	W	~67	~150	~225	~300	~375	~450	~525	~600
		1巾(片開き)	2巾	3巾	4巾	5巾	6巾	7巾	8巾
~100		14,600	29,200	43,000	57,600	71,300	85,900	99,700	
~120		14,600	29,200	43,000	57,600	71,300	85,900	99,700	
~140		14,600	29,200	43,000	57,600	71,300	85,900	99,700	
~160		19,500	38,200	57,600	76,200	94,900	114,300	132,900	
~180		19,500	38,200	57,600	76,200	94,900	114,300	132,900	
~200		24,300	47,900	71,300	94,900	119,200	142,600	166,200	
~220		24,300	47,900	71,300	94,900	119,200	142,600	166,200	
~240		24,300	47,900	71,300	94,900	119,200	142,600	166,200	
~260		29,200	57,600	85,900	114,300	142,600	171,000	199,300	
~280		29,200	57,600	85,900	114,300	142,600	171,000	199,300	
約1.5倍ヒダ		~88	~200	~300	~400	~500			

※片開きはW270cmまで

H	W	~67	~150	~225	~300	~375	~450	~525	~600
		1巾(片開き)	2巾	3巾	4巾	5巾	6巾	7巾	8巾
~100		15,200	30,300	44,600	59,800	74,000	89,100	103,400	
~120		15,200	30,300	44,600	59,800	74,000	89,100	103,400	
~140		15,200	30,300	44,600	59,800	74,000	89,100	103,400	
~160		20,200	39,600	59,800	79,000	98,400	118,600	137,800	
~180		20,200	39,600	59,800	79,000	98,400	118,600	137,800	
~200		25,200	49,700	74,000	98,400	123,600	147,900	172,300	
~220		25,200	49,700	74,000	98,400	123,600	147,900	172,300	
~240		25,200	49,700	74,000	98,400	123,600	147,900	172,300	
~260		30,300	59,800	89,100	118,600	147,900	177,400	206,700	
~280		30,300	59,800	89,100	118,600	147,900	177,400	206,700	
約1.5倍ヒダ		~88	~200	~300	~400	~500			

※片開きはW270cmまで

H	W	~67	~150	~225	~300	~375	~450	~525	~600
		1巾(片開き)	2巾	3巾	4巾	5巾	6巾	7巾	8巾
~100		16,200	32,400	47,800	64,000	79,200	95,400	110,800	127,000
~120		16,200	32,400	47,800	64,000	79,200	95,400	110,800	127,000
~140		16,200	32,400	47,800	64,000	79,200	95,400	110,800	127,000
~160		21,600	42,400	64,000	84,600	105,400	127,000	147,600	169,200
~180		21,600	42,400	64,000	84,600	105,400	127,000	147,600	169,200
~200		27,000	53,200	79,200	105,400	132,400	158,400	184,600	210,600
~220		27,000	53,200	79,200	105,400	132,400	158,400	184,600	210,600
~240		27,000	53,200	79,200	105,400	132,400	158,400	184,600	210,600
~260		32,400	64,000	95,400	127,000	158,400	190,000	221,400	253,000
~280		32,400	64,000	95,400	127,000	158,400	190,000	221,400	253,000

※片開きはW300cmまで

H	W	コード式					ドラム式							
		30~45	~90	~140	~190	~240	30~45	~90	~140	~190	~240	~290	~340	~390
50~100		16,400	20,400	24,900	35,000	39,700	19,400	23,400	27,900	38,000	42,700	50,000	61,000	65,800
~140		20,400	24,400	29,200	42,300	47,200	23,400	27,400	32,200	45,300	50,200	57,900	71,600	76,500
~180		24,400	28,400	33,400	49,100	54,200	27,400	31,400	36,400	52,100	57,200	65,100	82,500	87,500
~220		28,500	32,500	37,700	56,300	61,700	31,500	35,500	40,700	59,300	64,700	73,000	93,100	98,200
~260		29,300	33,400	38,800	57,600	63,100	32,300	36,400	41,800	60,600	66,100	74,500	94,900	99,900
~300		33,300	37,500	43,100	64,900	70,700	36,300	40,500	46,100	67,900	73,700	82,400	105,800	111,100

※ドラム式: 仕上り巾39cm以下の場合、仕上り丈は200cmまでとなります。

H	W	コード式
		18~30
~140		25,200
~180		29,100
~220		33,400
~240		34,400

H	W	コード式					ドラム式							
		30~45	~90	~140	~190	~240	30~45	~90	~140	~190	~240	~290	~340	~390
50~100		19,200	25,500	32,100	45,200	51,500	22,200	28,500	35,100	48,200	54,500	62,700	75,800	82,300
~140		23,500	30,200	37,300	54,100	61,000	26,500	33,200	40,300	57,100	64,000	72,600	88,700	95,500
~180		27,800	34,900	42,400	62,400	70,000	30,800	37,900	45,400	65,400	73,000	81,900	102,400	109,700
~220		32,100	39,600	47,600	71,300	79,500	35,100	42,600	50,600	74,300	82,500	91,700	115,000	122,700
~260		33,200	41,400	50,000	74,300	83,100	36,200	44,400	53,000	77,300	86,100	95,900	119,700	127,900
~300		37,700	46,300	55,600	83,700	93,300	40,700	49,300	58,600	86,700	96,300	106,600	134,100	142,700

※ドラム式: 仕上り巾39cm以下の場合、仕上り丈は200cmまでとなります。

H	W	コード式					ドラム式							
		1S	2S	3S	4S	5S	1S	2S	3S	4S	5S	6S	7S	8S
100~140		25,700	42,600	59,800	77,500	96,500	28,700	45,600	62,800	80,500	99,500	110,400	129,800	148,800
~180		30,700	50,700	72,100	93,200	116,200	33,700	53,700	75,100	96,200	119,200	131,100	154,600	177,600
~220		35,600	59,200	84,000	108,800	136,300	38,600	62,200	87,000	111,800	139,300	152,200	179,300	206,400
~260		36,900	62,000	87,700	113,400	142,200	39,900	65,000	90,700	116,400	145,200	159,000	187,300	211,600
~300		42,600	70,600	100,100	129,500	161,900	45,600	73,600	103,100	132,500	164,900	179,600	212,000	244,300

※出窓の場合はコーナー1ヶ所につきコード式は3,500円、ドラム式は4,500円プラスとなります。

レース



巾 ◇ 150cm 価格 ◇ 6,150円/m
 組成 ◇ ポリエステル100%

リポート ◇ タテ 58.7cm ヨコ 75.0cm
 寸法変化率 ◇ 水洗い/タテ 0.0% ヨコ 0.0%
 ドライ/タテ 0.0% ヨコ 0.0%

取扱い表示 ◇ リ-30
 防炎性能 ◇ (イ) あて布使用
 Made in Japan

H	W	~67 1巾(片開き)	~150 2巾	~225 3巾	~300 4巾	~375 5巾	~450 6巾	~525 7巾	~600 8巾
~100		14,400	28,700	42,200	56,600	70,000	84,300	98,600	112,200
~120		14,400	28,700	42,200	56,600	70,000	84,300	98,600	112,200
~140		14,400	28,700	42,200	56,600	70,000	84,300	98,600	112,200
~160		19,100	37,500	56,600	74,800	93,900	112,200	131,300	149,500
~180		19,100	37,500	56,600	74,800	93,900	112,200	131,300	149,500
~200		19,100	37,500	56,600	74,800	93,900	112,200	131,300	149,500
~220		23,900	47,000	70,000	93,900	117,000	140,800	163,800	186,900
~240		23,900	47,000	70,000	93,900	117,000	140,800	163,800	186,900
~260		28,700	56,600	84,300	112,200	140,800	168,600	196,500	224,200
~280		28,700	56,600	84,300	112,200	140,800	168,600	196,500	224,200
約1.5倍ヒダ		~88	~200	~300	~400	~500	~600	~700	~800
フラット前ヒダ		~130	~260	~410	~560				

H	W	~67 1巾(片開き)	~150 2巾	~225 3巾	~300 4巾	~375 5巾	~450 6巾	~525 7巾	~600 8巾
~100		14,900	29,700	43,800	58,700	72,600	87,500	102,300	117,200
~120		14,900	29,700	43,800	58,700	72,600	87,500	102,300	117,200
~140		14,900	29,700	43,800	58,700	72,600	87,500	102,300	117,200
~160		19,800	39,600	59,400	79,200	98,900	118,700	138,500	158,300
~180		19,800	39,600	59,400	79,200	98,900	118,700	138,500	158,300
~200		19,800	39,600	59,400	79,200	98,900	118,700	138,500	158,300
~220		24,800	49,600	74,400	99,200	123,900	148,700	173,500	198,200
~240		24,800	49,600	74,400	99,200	123,900	148,700	173,500	198,200
~260		29,700	59,400	89,100	118,800	148,500	178,200	207,900	237,600
~280		29,700	59,400	89,100	118,800	148,500	178,200	207,900	237,600
約1.5倍ヒダ		~88	~200	~300	~400	~500			

※片開きはW270cmまで

H	W	~67 1巾(片開き)	~150 2巾	~225 3巾	~300 4巾	~375 5巾	~450 6巾	~525 7巾	~600 8巾
~100		15,400	30,800	45,400	60,800	75,300	90,700	106,100	121,500
~120		15,400	30,800	45,400	60,800	75,300	90,700	106,100	121,500
~140		15,400	30,800	45,400	60,800	75,300	90,700	106,100	121,500
~160		20,600	41,200	61,800	82,400	103,000	123,600	144,200	164,800
~180		20,600	41,200	61,800	82,400	103,000	123,600	144,200	164,800
~200		20,600	41,200	61,800	82,400	103,000	123,600	144,200	164,800
~220		25,700	51,400	77,100	102,800	128,500	154,200	179,900	205,600
~240		25,700	51,400	77,100	102,800	128,500	154,200	179,900	205,600
~260		30,800	61,600	92,400	123,200	154,000	184,800	215,600	246,400
~280		30,800	61,600	92,400	123,200	154,000	184,800	215,600	246,400
約1.5倍ヒダ		~88	~200	~300	~400	~500			

※片開きはW270cmまで

H	W	~67 1巾(片開き)	~150 2巾	~225 3巾	~300 4巾	~375 5巾	~450 6巾	~525 7巾	~600 8巾
~100		16,500	33,000	49,500	66,000	82,500	99,000	115,500	132,000
~120		16,500	33,000	49,500	66,000	82,500	99,000	115,500	132,000
~140		16,500	33,000	49,500	66,000	82,500	99,000	115,500	132,000
~160		22,000	44,000	66,000	88,000	110,000	132,000	154,000	176,000
~180		22,000	44,000	66,000	88,000	110,000	132,000	154,000	176,000
~200		22,000	44,000	66,000	88,000	110,000	132,000	154,000	176,000
~220		27,500	55,000	82,500	110,000	137,500	165,000	192,500	220,000
~240		27,500	55,000	82,500	110,000	137,500	165,000	192,500	220,000
~260		33,000	66,000	99,000	132,000	165,000	198,000	231,000	264,000
~280		33,000	66,000	99,000	132,000	165,000	198,000	231,000	264,000
約1.5倍ヒダ		~88	~200	~300	~400	~500			

※片開きはW300cmまで

コード式					ドラム式									
H	W	30~45	~90	~140	~190	~240	30~45	~90	~140	~190	~240	~290	~340	~390
50~100		16,500	20,500	25,100	35,300	40,000	19,500	23,500	28,100	38,300	43,000	50,300	61,500	66,300
~140		20,700	24,700	29,400	42,700	47,700	23,700	27,700	32,400	45,700	50,700	58,400	72,300	77,200
~180		24,700	28,700	33,700	49,700	54,800	27,700	31,700	36,700	52,700	57,800	65,700	83,400	88,400
~220		25,600	29,700	34,900	50,900	56,200	28,600	32,700	37,900	53,900	59,200	67,400	85,200	90,300
~260		29,700	33,800	39,200	58,300	63,900	32,700	36,800	42,200	61,300	66,900	75,200	96,000	101,000
~300		33,800	37,900	43,500	65,800	71,500	36,800	40,900	46,500	68,800	74,500	83,300	107,100	112,500

※ドラム式: 仕上り巾39cm以下の場合、仕上り丈は200cmまでとなります。

コード式	
H	W
50~100	18~30
~140	21,000
~180	25,400
~220	29,400
~240	30,900
~240	34,800

コード式					ドラム式									
H	W	30~45	~90	~140	~190	~240	30~45	~90	~140	~190	~240	~290	~340	~390
50~100		19,400	25,600	32,300	45,500	51,900	22,400	28,600	35,300	48,500	54,900	63,100	76,300	82,800
~140		23,700	30,400	37,500	54,600	61,500	26,700	33,400	40,500	57,600	64,500	73,100	89,400	96,200
~180		28,100	35,200	42,800	63,100	70,600	31,100	38,200	45,800	66,100	73,600	82,500	103,300	110,600
~220		29,200	36,700	44,700	65,500	73,600	32,200	39,700	47,700	68,500	76,600	85,900	106,800	114,500
~260		33,600	41,800	50,400	75,100	83,900	36,600	44,800	53,400	78,100	86,900	96,700	120,900	129,000
~300		38,100	46,800	56,100	84,700	94,200	41,100	49,800	59,100	87,700	97,200	107,500	135,500	144,200

※ドラム式: 仕上り巾39cm以下の場合、仕上り丈は200cmまでとなります。

コード式					ドラム式									
スワッグ数	1S	2S	3S	4S	5S	1S	2S	3S	4S	5S	6S	7S	8S	
H	36~50	~100	~150	~200	~250	40~50	~100	~150	~200	~250	~300	~350	~400	
100~140		26,000	43,000	60,500	78,400	97,500	29,000	46,000	63,500	81,400	100,500	111,500	131,100	150,800
~180		30,900	51,200	73,000	94,300	118,100	33,900	54,200	76,000	97,300	121,100	133,000	156,300	180,100
~220		33,000	54,000	76,700	98,900	123,800	36,000	57,000	79,700	101,900	126,800	139,700	164,200	189,200
~260		37,200	62,700	88,800	115,300	143,900	40,200	65,700	91,800	118,300	146,900	160,800	189,900	214,500
~300		43,000	71,400	101,300	131,200	164,500	46,000	74,400	104,300	134,200	167,500	182,200	215,000	247,700

※出窓の場合はコーナー1ヶ所につきコード式は3,500円、ドラム式は4,500円プラスになります。

TM-54329~54331

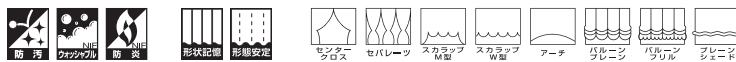

巾 ◇ 300cm ヨコ使い 価格 ◇ 5,100円/m リピート ◇ タテ cm ヨコ 8.5cm 取扱い表示 ◇ リ-30 防炎性能 ◇ (イ)
 組成 ◇ ポリエステル100% 寸法変化率 ◇ 水洗い/タテ 0.0% ヨコ 0.2% ドライ/タテ -0.2% ヨコ -0.2% Made in Japan

H	W	~50 (片開き)	~100	~150	~200	~250	~300	~350	~400
~100	7,500	14,200	21,000	27,800	34,600	41,400	48,100	54,900	
~120	7,800	14,800	21,900	28,900	35,900	42,900	49,900	57,000	
~140	8,100	15,300	22,600	29,800	37,100	44,000	51,600	58,900	
~160	8,300	15,800	23,300	30,800	38,300	45,800	53,300	60,800	
~180	8,500	16,300	24,000	31,800	39,500	47,200	55,000	62,700	
~200	8,800	16,800	24,700	32,700	40,700	48,700	56,700	64,600	
~220	9,100	17,400	25,600	33,800	42,000	50,200	58,500	66,700	
~240	9,400	17,800	26,300	34,800	43,200	51,700	60,100	68,600	
~260	9,600	18,300	27,000	35,700	44,400	53,100	61,800	70,500	
約1.5倍ヒダ	~60	~120	~200	~266	~333	~400	~466	~533	
フラット前ヒダ	~90	~160	~260	~360	~460	~560			

H	W	~50 (片開き)	~100	~150	~200	~250	~300	~350	~400
~100	8,100	15,400	22,700	30,100	37,400	44,800	52,100	59,400	
~120	8,500	16,200	23,900	31,500	39,200	46,800	54,500	62,200	
~140	8,900	16,800	24,800	32,800	40,800	48,800	56,700	64,700	
~160	9,200	17,500	25,800	34,100	42,400	50,700	59,000	67,300	
~180	9,500	18,100	26,700	35,400	44,000	52,600	61,200	69,800	
~200	9,800	18,800	27,700	36,600	45,600	54,500	63,500	72,400	
~220	10,300	19,600	28,800	38,100	47,300	56,600	65,900	75,100	
~240	10,600	20,200	29,800	39,400	48,900	58,500	68,100	77,700	
~260	10,900	20,800	30,700	40,600	50,500	60,400	70,300	80,200	
~280	10,900	20,800	30,700	40,600	50,500	60,400	70,300	80,200	
約1.5倍ヒダ	~60	~120	~200	~266	~333	~400	~466	~533	
フラット前ヒダ	~90	~160	~260	~360	~460	~560			

H	W	~50 (片開き)	~100	~150	~200	~250	~300	~350	~400
~100	7,800	14,800	21,900	28,900	36,000	43,100	50,100	57,200	
~120	8,200	15,500	22,900	30,200	37,500	44,900	52,200	59,600	
~140	8,500	16,100	23,700	31,300	38,900	46,600	54,200	61,800	
~160	8,700	16,600	24,500	32,400	40,300	48,200	56,100	64,000	
~180	9,000	17,200	25,400	33,600	41,700	49,900	58,100	66,300	
~200	9,300	17,800	26,200	34,700	43,100	51,600	60,100	68,500	
~220	9,700	18,500	27,200	35,900	44,700	53,400	62,200	70,900	
~240	10,000	19,000	28,000	37,100	46,100	55,100	64,100	73,100	
~260	10,300	19,600	28,900	38,200	47,500	56,800	66,100	75,400	
約1.5倍ヒダ	~60	~120	~200	~266	~333	~400	~466	~533	

H	W	~50 (片開き)	~100	~150	~200	~250	~300	~350	~400
~100	8,400	16,000	23,600	31,200	38,800	46,500	54,100	61,700	
~120	8,900	16,900	24,900	32,800	40,800	48,800	56,800	64,800	
~140	9,300	17,600	25,900	34,300	42,600	51,000	59,300	67,600	
~160	9,600	18,300	27,000	35,700	44,400	53,100	61,800	70,500	
~180	10,000	19,000	28,100	37,200	46,200	55,300	64,300	73,400	
~200	10,300	19,800	29,200	38,600	48,000	57,400	66,900	76,300	
~220	10,900	20,700	30,400	40,200	50,000	59,800	69,600	79,300	
~240	11,200	21,400	31,500	41,700	51,800	61,900	72,100	82,200	
~260	11,600	22,100	32,600	43,100	53,600	64,100	74,600	85,100	
~280	11,600	22,100	32,600	43,100	53,600	64,100	74,600	85,100	
約1.5倍ヒダ	~60	~120	~200	~266	~333	~400	~466	~533	

H	W	~50 (片開き)	~100	~150	~200	~250	~300	~350	~400
~100	8,100	15,400	22,700	30,100	37,400	44,800	52,100	59,400	
~120	8,500	16,200	23,900	31,500	39,200	46,800	54,500	62,200	
~140	8,900	16,800	24,800	32,800	40,800	48,800	56,700	64,700	
~160	9,200	17,500	25,800	34,100	42,400	50,700	59,000	67,300	
~180	9,500	18,100	26,700	35,400	44,000	52,600	61,200	69,800	
~200	9,800	18,800	27,700	36,600	45,600	54,500	63,500	72,400	
~220	10,300	19,600	28,800	38,100	47,300	56,600	65,900	75,100	
~240	10,600	20,200	29,800	39,400	48,900	58,500	68,100	77,700	
~260	10,900	20,800	30,700	40,600	50,500	60,400	70,300	80,200	
約1.5倍ヒダ	~60	~120	~200	~266	~333	~400	~466	~533	

H	W	~50 (片開き)	~100	~150	~200	~250	~300	~350	~400
~100	8,700	16,600	24,500	32,400	40,300	48,200	56,100	64,000	
~120	9,300	17,600	25,900	34,200	42,500	50,800	59,100	67,400	
~140	9,700	18,400	27,100	35,800	44,500	53,200	61,900	70,600	
~160	10,100	19,200	28,300	37,400	46,500	55,600	64,700	73,800	
~180	10,500	20,000	29,500	39,000	48,500	58,000	67,500	77,000	
~200	10,900	20,800	30,700	40,600	50,500	60,400	70,300	80,200	
~220	11,500	21,800	32,100	42,400	52,700	63,000	73,300	83,600	
~240	11,900	22,600	33,300	44,000	54,700	65,400	76,100	86,800	
~260	12,300	23,400	34,500	45,600	56,700	67,800	78,900	90,000	
約1.5倍ヒダ	~60	~120	~200	~266	~333	~400	~466	~533	

センタークロス

H	W	~80	~120	~160	~200	~240	~280	~320
~100	12,000	16,000						
~120	12,800	16,900	22,900					
~140	13,200	18,200	24,100	30,000				
~160	17,800	25,200	34,300	42,100	49,800			
~180	18,500	26,600	35,500	44,000	51,500	62,600		
~200	19,500	27,400	37,000	45,000	54,800	64,700	74,600	
~220	20,100	28,700	38,300	46,900	55,400	67,200	76,100	
~240	21,100	29,600	39,900	48,400	57,500	69,300	78,900	
~260	22,100	32,100	41,500	50,200	59,300	71,800	79,900	

セパレート

H	W	~40(1P)	~50(1P)	~60(1P)
~100	12,900	14,500	16,400	
~120	13,800	15,900	17,800	
~140	15,100	16,800	19,100	
~160	18,500	21,300	23,700	
~180	19,800	22,300	25,000	
~200	20,800	23,600	25,900	
~220	22,000	24,400	27,200	
~240	23,300	25,600	27,700	
~260	24,300	26,700	28,700	

レースフレンジ style no.12 (タッセル含む)

H	W	~80	~120	~160	~200	~240	~280	~320
~100	15,100	20,300						
~120	15,900	21,600	28,500					
~140	16,700	22,900	30,100	37,200				
~160	21,400	30,300	40,400	49,700	58,200			
~180	22,400	31,700	42,000	51,600	60,300	72,600		
~200	23,400	32,900	43,500	53,000	63,600	75,100	86,300	
~220	24,500	34,200	45,200	55,000	64,700	77,600	88,300	
~240	25,500	35,500	46,900	56,800	66,800	80,200	91,100	
~260	26,600	38,100	48,500	58,700	69,000	82,700	92,500	

スカラップM型

ウェーブ数	3W	4W	5W	6W	7W	
Uエープ	100~130	~160	~190	~240	~290	~330
80~100	16,100	21,000	25,500	31,400	40,200	45,600
~120	18,700	25,300	30,400	37,800	47,700	53,800
~140	19,400	26,300	31,700	39,400	49,700	56,700
~160	26,800	35,400	42,800	53,300	67,600	77,700
~180	36,500	44,000	54,900	69,600	80,600	
~200		45,300	56,500	71,600	83,500	

スカラップW型

ウェーブ数	2W	3W	4W	5W	6W	7W	
Uエープ	60~100	~130	~160	~190	~240	~290	~330
80~100	12,700	16,100	21,000	25,500	31,400	40,200	45,600
~120	14,900	18,700	25,300	30,400	37,800	47,700	53,800
~140	15,500	19,400	26,300	31,700	39,400	49,700	56,700
~160	26,800	35,400	42,800	53,300	67,600	77,700	
~180	36,500	44,000	54,900	69,600	80,600		
~200		45,300	56,500	71,600	83,500		

アーチ

H	W	60~100	~130	~160	~190	~240	~290	~330
80~100	12,300	15,700	20,600	24,700	30,600	38,900	44,300	

		style no.60 プレーンシェード												
		コード式					ドラム式							
H	W	30~45	~90	~140	~190	~240	30~45	~90	~140	~190	~240	~290	~340	~390
50~100		15,400	19,400	24,000	28,100	32,700	18,400	22,400	27,000	31,100	35,700	42,900	53,000	57,800
	~140	18,100	22,200	26,900	31,000	35,900	21,100	25,200	29,900	34,000	38,900	46,400	58,300	63,200
	~180	20,700	24,800	29,800	33,900	39,100	23,700	27,800	32,800	36,900	42,100	49,600	63,400	68,400
	~220	23,400	27,500	32,700	36,900	42,200	26,400	30,500	35,700	39,900	45,200	53,100	68,700	73,800
	~260	26,000	30,200	35,600	39,800	45,400	29,000	33,200	38,600	42,800	48,400	56,300	74,000	79,000
	~280	28,600	32,900	38,500	42,800	48,600	31,600	35,900	41,500	45,800	51,600	59,800	79,200	84,500

※ドラム式: 仕上り巾39cm以下の場合、仕上り丈は200cmまでとなります。

		コード式
H	W	18~30
50~100		19,900
	~140	23,100
	~180	25,700
	~220	28,800
	~240	30,700

		style no.50 バルーンプレーン												
		コード式					ドラム式							
スワッグ数		1S	2S	3S	4S	5S	1S	2S	3S	4S	5S	6S	7S	8S
H	W	36~50	~100	~150	~200	~250	40~50	~100	~150	~200	~250	~300	~350	~400
100~140		22,400	35,900	50,300	64,700	80,800	25,400	38,900	53,300	67,700	83,800	100,000	116,100	132,200
	~180	24,400	38,700	54,000	69,300	86,500	27,400	41,700	57,000	72,300	89,500	106,800	124,000	141,300
	~220	26,500	41,500	57,700	73,900	92,300	29,500	44,500	60,700	76,900	95,300	113,500	132,000	150,400
	~260	27,800	44,300	61,400	78,400	98,100	30,800	47,300	64,400	81,400	101,100	120,300	139,900	155,600
	~280	30,600	47,100	65,100	83,000	103,900	33,600	50,100	68,100	86,000	106,900	127,000	147,800	168,700

※出窓の場合はコーナー1ヶ所につきコード式は3,500円、ドラム式は4,500円プラスになります。

		style no.51 バルーンフリル												
		コード式					ドラム式							
スワッグ数		1S	2S	3S	4S	5S	1S	2S	3S	4S	5S	6S	7S	8S
H	W	36~50	~100	~150	~200	~250	40~50	~100	~150	~200	~250	~300	~350	~400
100~140		23,600	38,400	54,400	70,000	87,300	26,600	41,400	57,400	73,000	90,300	107,700	125,100	142,400
	~180	25,700	41,200	58,100	74,600	93,100	28,700	44,200	61,100	77,600	96,100	114,500	133,000	151,500
	~220	27,700	44,000	61,800	79,200	98,800	30,700	47,000	64,800	82,200	101,800	121,200	140,900	160,600
	~260	29,000	46,800	65,500	83,700	104,600	32,000	49,800	68,500	86,700	107,600	128,000	148,900	165,800
	~280	31,800	49,600	69,200	88,300	110,400	34,800	52,600	72,200	91,300	113,400	134,700	156,800	178,900

※出窓の場合はコーナー1ヶ所につきコード式は3,500円、ドラム式は4,500円プラスになります。

TM-54332~54335

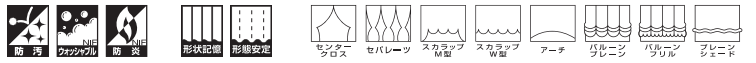

巾 ◇ 300cm ヨコ使い 価格 ◇ 5,100円/m リポート ◇ タテ cm ヨコ 7.4cm 取扱い表示 ◇ リ-30 防炎性能 ◇ (イ)
 組成 ◇ ポリエステル100% 寸法変化率 ◇ 水洗い/タテ -0.5% ヨコ 0.0% ドライ/タテ 0.0% ヨコ 0.0% Made in Japan

H	W	~50 (片開き)	~100	~150	~200	~250	~300	~350	~400
~100	7,500	14,200	21,000	27,800	34,600	41,400	48,100	54,900	
~120	7,800	14,800	21,900	28,900	35,900	42,900	49,900	57,000	
~140	8,100	15,300	22,600	29,800	37,100	44,900	51,600	58,900	
~160	8,300	15,800	23,300	30,800	38,300	45,800	53,300	60,800	
~180	8,500	16,300	24,000	31,800	39,500	47,200	55,000	62,700	
~200	8,800	16,800	24,700	32,700	40,700	48,700	56,700	64,600	
~220	9,100	17,400	25,600	33,800	42,000	50,200	58,500	66,700	
~240	9,400	17,800	26,300	34,800	43,200	51,700	60,100	68,600	
~260	9,600	18,300	27,000	35,700	44,400	53,100	61,800	70,500	
約1.5倍ヒダ	~60	~120	~200	~266	~333	~400	~466	~533	
フラット前ヒダ	~90	~160	~260	~360	~460	~560			

H	W	~50 (片開き)	~100	~150	~200	~250	~300	~350	~400
~100	8,100	15,400	22,700	30,100	37,400	44,800	52,100	59,400	
~120	8,500	16,200	23,900	31,500	39,200	46,800	54,500	62,200	
~140	8,900	16,800	24,800	32,800	40,800	48,800	56,700	64,700	
~160	9,200	17,500	25,800	34,100	42,400	50,700	59,000	67,300	
~180	9,500	18,100	26,700	35,400	44,000	52,600	61,200	69,800	
~200	9,800	18,800	27,700	36,600	45,600	54,500	63,500	72,400	
~220	10,300	19,600	28,800	38,100	47,300	56,600	65,900	75,100	
~240	10,600	20,200	29,800	39,400	48,900	58,500	68,100	77,700	
~260	10,900	20,800	30,700	40,600	50,500	60,400	70,300	80,200	
~280	10,900	20,800	30,700	40,600	50,500	60,400	70,300	80,200	
約1.5倍ヒダ	~60	~120	~200	~266	~333	~400	~466	~533	
フラット前ヒダ	~90	~160	~260	~360	~460	~560			

H	W	~50 (片開き)	~100	~150	~200	~250	~300	~350	~400
~100	7,800	14,800	21,900	28,900	36,000	43,100	50,100	57,200	
~120	8,200	15,500	22,900	30,200	37,500	44,900	52,200	59,600	
~140	8,500	16,100	23,700	31,300	38,900	46,600	54,200	61,800	
~160	8,700	16,600	24,500	32,400	40,300	48,200	56,100	64,000	
~180	9,000	17,200	25,400	33,600	41,700	49,900	58,100	66,300	
~200	9,300	17,800	26,200	34,700	43,100	51,600	60,100	68,500	
~220	9,700	18,500	27,200	35,900	44,700	53,400	62,200	70,900	
~240	10,000	19,000	28,000	37,100	46,100	55,100	64,100	73,100	
~260	10,300	19,600	28,900	38,200	47,500	56,800	66,100	75,400	
約1.5倍ヒダ	~60	~120	~200	~266	~333	~400	~466	~533	

H	W	~50 (片開き)	~100	~150	~200	~250	~300	~350	~400
~100	8,400	16,000	23,600	31,200	38,800	46,500	54,100	61,700	
~120	8,900	16,900	24,900	32,800	40,800	48,800	56,800	64,800	
~140	9,300	17,600	25,900	34,300	42,600	51,000	59,300	67,600	
~160	9,600	18,300	27,000	35,700	44,400	53,100	61,800	70,500	
~180	10,000	19,000	28,100	37,200	46,200	55,300	64,300	73,400	
~200	10,300	19,800	29,200	38,600	48,000	57,400	66,900	76,300	
~220	10,900	20,700	30,400	40,200	50,000	59,800	69,600	79,300	
~240	11,200	21,400	31,500	41,700	51,800	61,900	72,100	82,200	
~260	11,600	22,100	32,600	43,100	53,600	64,100	74,600	85,100	
~280	11,600	22,100	32,600	43,100	53,600	64,100	74,600	85,100	
約1.5倍ヒダ	~60	~120	~200	~266	~333	~400	~466	~533	

H	W	~50 (片開き)	~100	~150	~200	~250	~300	~350	~400
~100	8,100	15,400	22,700	30,100	37,400	44,800	52,100	59,400	
~120	8,500	16,200	23,900	31,500	39,200	46,800	54,500	62,200	
~140	8,900	16,800	24,800	32,800	40,800	48,800	56,700	64,700	
~160	9,200	17,500	25,800	34,100	42,400	50,700	59,000	67,300	
~180	9,500	18,100	26,700	35,400	44,000	52,600	61,200	69,800	
~200	9,800	18,800	27,700	36,600	45,600	54,500	63,500	72,400	
~220	10,300	19,600	28,800	38,100	47,300	56,600	65,900	75,100	
~240	10,600	20,200	29,800	39,400	48,900	58,500	68,100	77,700	
~260	10,900	20,800	30,700	40,600	50,500	60,400	70,300	80,200	
約1.5倍ヒダ	~60	~120	~200	~266	~333	~400	~466	~533	

H	W	~50 (片開き)	~100	~150	~200	~250	~300	~350	~400
~100	8,700	16,600	24,500	32,400	40,300	48,200	56,100	64,000	
~120	9,300	17,600	25,900	34,200	42,500	50,800	59,100	67,400	
~140	9,700	18,400	27,100	35,800	44,500	53,200	61,900	70,600	
~160	10,100	19,200	28,300	37,400	46,500	55,600	64,700	73,800	
~180	10,500	20,000	29,500	39,000	48,500	58,000	67,500	77,000	
~200	10,900	20,800	30,700	40,600	50,500	60,400	70,300	80,200	
~220	11,500	21,800	32,100	42,400	52,700	63,000	73,300	83,600	
~240	11,900	22,600	33,300	44,000	54,700	65,400	76,100	86,800	
~260	12,300	23,400	34,500	45,600	56,700	67,800	78,900	90,000	
約1.5倍ヒダ	~60	~120	~200	~266	~333	~400	~466	~533	

センタークロス

H	W	~80	~120	~160	~200	~240	~280	~320
~100	12,000	16,000						
~120	12,800	16,900	22,900					
~140	13,200	18,200	24,100	30,000				
~160	17,800	25,200	34,300	42,100	49,800			
~180	18,500	26,600	35,500	44,000	51,500	62,600		
~200	19,500	27,400	37,000	45,000	54,800	64,700	74,600	
~220	20,100	28,700	38,300	46,900	55,400	67,200	76,100	
~240	21,100	29,600	39,900	48,400	57,500	69,300	78,900	
~260	22,100	32,100	41,500	50,200	59,300	71,800	79,900	

セパレート

H	W	~40(1P)	~50(1P)	~60(1P)
~100	12,900	14,500	16,400	
~120	13,800	15,900	17,800	
~140	15,100	16,800	19,100	
~160	18,500	21,300	23,700	
~180	19,800	22,300	25,000	
~200	20,800	23,600	25,900	
~220	22,000	24,400	27,200	
~240	23,300	25,600	27,700	
~260	24,300	26,700	28,700	

レースフレンジ style no.12 (タッセル含む)

H	W	~80	~120	~160	~200	~240	~280	~320
~100	15,100	20,300						
~120	15,900	21,600	28,500					
~140	16,700	22,900	30,100	37,200				
~160	21,400	30,300	40,400	49,700	58,200			
~180	22,400	31,700	42,000	51,600	60,300	72,600		
~200	23,400	32,900	43,500	53,000	63,600	75,100	86,300	
~220	24,500	34,200	45,200	55,000	64,700	77,600	88,300	
~240	25,500	35,500	46,900	56,800	66,800	80,200	91,100	
~260	26,600	38,100	48,500	58,700	69,000	82,700	92,500	

スカラップM型

ウェーブ数	3W	4W	5W	6W	7W
100~130	~160	~190	~240	~290	~330
80~100	16,100	21,000	25,500	31,400	40,200
~120	18,700	25,300	30,400	37,800	47,700
~140	19,400	26,300	31,700	39,400	49,700
~160	26,800	35,400	42,800	53,300	67,600
~180	36,500	44,000	54,900	69,600	80,600
~200		45,300	56,500	71,600	83,500

スカラップW型

ウェーブ数	2W	3W	4W	5W	6W	7W
60~100	~130	~160	~190	~240	~290	~330
80~100	12,700	16,100	21,000	25,500	31,400	40,200
~120	14,900	18,700	25,300	30,400	37,800	47,700
~140	15,500	19,400	26,300	31,700	39,400	49,700
~160	26,800	35,400	42,800	53,300	67,600	77,700
~180		36,500	44,000	54,900	69,600	80,600
~200			45,300	56,500	71,600	83,500

アーチ

H	W	60~100	~130	~160	~190	~240	~290	~330
80~100	14,600	18,500	24,600	29,200	36,700	46,200	52,900	
~120	14,500	18,300	24,900	29,600	37,000	46,400	52,500	

		style no.60 プレーンシェード												
		コード式					ドラム式							
H	W	30~45	~90	~140	~190	~240	30~45	~90	~140	~190	~240	~290	~340	~390
50~100		15,400	19,400	24,000	28,100	32,700	18,400	22,400	27,000	31,100	35,700	42,900	53,000	57,800
	~140	18,100	22,200	26,900	31,000	35,900	21,100	25,200	29,900	34,000	38,900	46,400	58,300	63,200
	~180	20,700	24,800	29,800	33,900	39,100	23,700	27,800	32,800	36,900	42,100	49,600	63,400	68,400
	~220	23,400	27,500	32,700	36,900	42,200	26,400	30,500	35,700	39,900	45,200	53,100	68,700	73,800
	~260	26,000	30,200	35,600	39,800	45,400	29,000	33,200	38,600	42,800	48,400	56,300	74,000	79,000
	~280	28,600	32,900	38,500	42,800	48,600	31,600	35,900	41,500	45,800	51,600	59,800	79,200	84,500

※ドラム式: 仕上り巾39cm以下の場合、仕上り丈は200cmまでとなります。

		コード式
H	W	18~30
50~100		19,900
	~140	23,100
	~180	25,700
	~220	28,800
	~240	30,700

		style no.50 バルーンプレーン												
		コード式					ドラム式							
スワッグ数		1S	2S	3S	4S	5S	1S	2S	3S	4S	5S	6S	7S	8S
H	W	36~50	~100	~150	~200	~250	40~50	~100	~150	~200	~250	~300	~350	~400
100~140		22,400	35,900	50,300	64,700	80,800	25,400	38,900	53,300	67,700	83,800	100,000	116,100	132,200
	~180	24,400	38,700	54,000	69,300	86,500	27,400	41,700	57,000	72,300	89,500	106,800	124,000	141,300
	~220	26,500	41,500	57,700	73,900	92,300	29,500	44,500	60,700	76,900	95,300	113,500	132,000	150,400
	~260	27,800	44,300	61,400	78,400	98,100	30,800	47,300	64,400	81,400	101,100	120,300	139,900	155,600
	~280	30,600	47,100	65,100	83,000	103,900	33,600	50,100	68,100	86,000	106,900	127,000	147,800	168,700

※出窓の場合はコーナー1ヶ所につきコード式は3,500円、ドラム式は4,500円プラスになります。

		style no.51 バルーンフリル												
		コード式					ドラム式							
スワッグ数		1S	2S	3S	4S	5S	1S	2S	3S	4S	5S	6S	7S	8S
H	W	36~50	~100	~150	~200	~250	40~50	~100	~150	~200	~250	~300	~350	~400
100~140		23,600	38,400	54,400	70,000	87,300	26,600	41,400	57,400	73,000	90,300	107,700	125,100	142,400
	~180	25,700	41,200	58,100	74,600	93,100	28,700	44,200	61,100	77,600	96,100	114,500	133,000	151,500
	~220	27,700	44,000	61,800	79,200	98,800	30,700	47,000	64,800	82,200	101,800	121,200	140,900	160,600
	~260	29,000	46,800	65,500	83,700	104,600	32,000	49,800	68,500	86,700	107,600	128,000	148,900	165,800
	~280	31,800	49,600	69,200	88,300	110,400	34,800	52,600	72,200	91,300	113,400	134,700	156,800	178,900

※出窓の場合はコーナー1ヶ所につきコード式は3,500円、ドラム式は4,500円プラスになります。

style no.60 プレーンシェード														
コード式						ドラム式								
H	W	30~45	~90	~140	~190	~240	30~45	~90	~140	~190	~240	~290	~340	~390
50~100		15,400	19,400	24,000	28,100	32,700	18,400	22,400	27,000	31,100	35,700	42,900	53,000	57,800
	~140	18,100	22,200	26,900	31,000	35,900	21,100	25,200	29,900	34,000	38,900	46,400	58,300	63,200
	~180	20,700	24,800	29,800	33,900	39,100	23,700	27,800	32,800	36,900	42,100	49,600	63,400	68,400
	~220	23,400	27,500	32,700	36,900	42,200	26,400	30,500	35,700	39,900	45,200	53,100	68,700	73,800
	~260	26,000	30,200	35,600	39,800	45,400	29,000	33,200	38,600	42,800	48,400	56,300	74,000	79,000
	~280	28,600	32,900	38,500	42,800	48,600	31,600	35,900	41,500	45,800	51,600	59,800	79,200	84,500

※ドラム式：仕上り巾39cm以下の場合、仕上り丈は200cmまでとなります。

スリムシェード		コード式
H	W	18~30
50~100		19,900
	~140	23,100
	~180	25,700
	~220	28,800
	~240	30,700

style no.63 シャープシェード														
コード式						ドラム式								
H	W	30~45	~90	~140	~190	~240	30~45	~90	~140	~190	~240	~290	~340	~390
50~100		18,200	24,500	31,100	37,700	44,100	21,200	27,500	34,100	40,700	47,100	55,300	67,400	73,900
	~140	21,100	27,800	34,900	42,000	48,900	24,100	30,800	37,900	45,000	51,900	60,500	74,800	81,600
	~180	24,000	31,100	38,700	46,200	53,800	27,000	34,100	41,700	49,200	56,800	65,700	82,400	89,700
	~220	26,900	34,400	42,500	50,500	58,600	29,900	37,400	45,500	53,500	61,600	70,900	89,500	97,200
	~260	29,900	38,000	46,600	55,300	64,100	32,900	41,000	49,600	58,300	67,100	76,900	97,900	106,000
	~280	32,900	41,600	50,800	60,100	69,600	35,900	44,600	53,800	63,100	72,600	82,900	106,200	114,900

※ドラム式：仕上り巾39cm以下の場合、仕上り丈は200cmまでとなります。

style no.50 バルーンプレーン														
コード式							ドラム式							
スラッグ数	1S	2S	3S	4S	5S		1S	2S	3S	4S	5S	6S	7S	8S
H	W	36~50	~100	~150	~200	~250	40~50	~100	~150	~200	~250	~300	~350	~400
100~140		22,400	35,900	50,300	64,700	80,800	25,400	38,900	53,300	67,700	83,800	100,000	116,100	132,200
	~180	24,400	38,700	54,000	69,300	86,500	27,400	41,700	57,000	72,300	89,500	106,800	124,000	141,300
	~220	26,500	41,500	57,700	73,900	92,300	29,500	44,500	60,700	76,900	95,300	113,500	132,000	150,400
	~260	27,800	44,300	61,400	78,400	98,100	30,800	47,300	64,400	81,400	101,100	120,300	139,900	155,600
	~280	30,600	47,100	65,100	83,000	103,900	33,600	50,100	68,100	86,000	106,900	127,000	147,800	168,700

※出窓の場合はコーナー1ヶ所につきコード式は3,500円、ドラム式は4,500円プラスになります。

style no.51 バルーンフリル														
コード式							ドラム式							
スラッグ数	1S	2S	3S	4S	5S		1S	2S	3S	4S	5S	6S	7S	8S
H	W	36~50	~100	~150	~200	~250	40~50	~100	~150	~200	~250	~300	~350	~400
100~140		23,600	38,400	54,400	70,000	87,300	26,600	41,400	57,400	73,000	90,300	107,700	125,100	142,400
	~180	25,700	41,200	58,100	74,600	93,100	28,700	44,200	61,100	77,600	96,100	114,500	133,000	151,500
	~220	27,700	44,000	61,800	79,200	98,800	30,700	47,000	64,800	82,200	101,800	121,200	140,900	160,600
	~260	29,000	46,800	65,500	83,700	104,600	32,000	49,800	68,500	86,700	107,600	128,000	148,900	165,800
	~280	31,800	49,600	69,200	88,300	110,400	34,800	52,600	72,200	91,300	113,400	134,700	156,800	178,900

※出窓の場合はコーナー1ヶ所につきコード式は3,500円、ドラム式は4,500円プラスになります。

style no.S01 ロールソフト									
スプリング・チェーンタイプ									
H	W	30~60	~80	~100	~120	~140	~160	~180	~190
50~80		30,700	33,200	35,200	36,400	38,100	40,600	43,200	45,700
	~120	33,500	36,600	38,600	39,700	41,600	44,100	46,500	49,100
	~160	36,200	40,000	42,000	43,200	44,500	46,900	49,400	51,900
	~200	40,000	43,000	45,200	46,400	47,700	50,300	52,800	55,300
	~240		46,300	48,600	49,800	51,200	53,700	56,200	58,800

※丈は巾の3倍までが限度です。

※ロールソフト加工品は非防炎品になります。

style no.60 プレーンシェード														
コード式						ドラム式								
H	W	30~45	~90	~140	~190	~240	30~45	~90	~140	~190	~240	~290	~340	~390
50~100		15,400	19,400	24,000	28,100	32,700	18,400	22,400	27,000	31,100	35,700	42,900	53,000	57,800
	~140	18,100	22,200	26,900	31,000	35,900	21,100	25,200	29,900	34,000	38,900	46,400	58,300	63,200
	~180	20,700	24,800	29,800	33,900	39,100	23,700	27,800	32,800	36,900	42,100	49,600	63,400	68,400
	~220	23,400	27,500	32,700	36,900	42,200	26,400	30,500	35,700	39,900	45,200	53,100	68,700	73,800
	~260	26,000	30,200	35,600	39,800	45,400	29,000	33,200	38,600	42,800	48,400	56,300	74,000	79,000
	~280	28,600	32,900	38,500	42,800	48,600	31,600	35,900	41,500	45,800	51,600	59,800	79,200	84,500

※ドラム式：仕上り巾39cm以下の場合、仕上り丈は200cmまでとなります。

スリムシェード		コード式
H	W	18~30
50~100		19,900
	~140	23,100
	~180	25,700
	~220	28,800
	~240	30,700

style no.63 シャープシェード														
コード式						ドラム式								
H	W	30~45	~90	~140	~190	~240	30~45	~90	~140	~190	~240	~290	~340	~390
50~100		18,200	24,500	31,100	37,700	44,100	21,200	27,500	34,100	40,700	47,100	55,300	67,400	73,900
	~140	21,100	27,800	34,900	42,000	48,900	24,100	30,800	37,900	45,000	51,900	60,500	74,800	81,600
	~180	24,000	31,100	38,700	46,200	53,800	27,000	34,100	41,700	49,200	56,800	65,700	82,400	89,700
	~220	26,900	34,400	42,500	50,500	58,600	29,900	37,400	45,500	53,500	61,600	70,900	89,500	97,200
	~260	29,900	38,000	46,600	55,300	64,100	32,900	41,000	49,600	58,300	67,100	76,900	97,900	106,000
	~280	32,900	41,600	50,800	60,100	69,600	35,900	44,600	53,800	63,100	72,600	82,900	106,200	114,900

※ドラム式：仕上り巾39cm以下の場合、仕上り丈は200cmまでとなります。

style no.50 バルーンプレーン														
コード式							ドラム式							
スラッグ数	1S	2S	3S	4S	5S		1S	2S	3S	4S	5S	6S	7S	8S
H	W	36~50	~100	~150	~200	~250	40~50	~100	~150	~200	~250	~300	~350	~400
100~140		22,400	35,900	50,300	64,700	80,800	25,400	38,900	53,300	67,700	83,800	100,000	116,100	132,200
	~180	24,400	38,700	54,000	69,300	86,500	27,400	41,700	57,000	72,300	89,500	106,800	124,000	141,300
	~220	26,500	41,500	57,700	73,900	92,300	29,500	44,500	60,700	76,900	95,300	113,500	132,000	150,400
	~260	27,800	44,300	61,400	78,400	98,100	30,800	47,300	64,400	81,400	101,100	120,300	139,900	155,600
	~280	30,600	47,100	65,100	83,000	103,900	33,600	50,100	68,100	86,000	106,900	127,000	147,800	168,700

※出窓の場合はコーナー1ヶ所につきコード式は3,500円、ドラム式は4,500円プラスになります。

style no.51 バルーンフリル														
コード式							ドラム式							
スラッグ数	1S	2S	3S	4S	5S		1S	2S	3S	4S	5S	6S	7S	8S
H	W	36~50	~100	~150	~200	~250	40~50	~100	~150	~200	~250	~300	~350	~400
100~140		23,600	38,400	54,400	70,000	87,300	26,600	41,400	57,400	73,000	90,300	107,700	125,100	142,400
	~180	25,700	41,200	58,100	74,600	93,100	28,700	44,200	61,100	77,600	96,100	114,500	133,000	151,500
	~220	27,700	44,000	61,800	79,200	98,800	30,700	47,000	64,800	82,200	101,800	121,200	140,900	160,600
	~260	29,000	46,800	65,500	83,700	104,600	32,000	49,800	68,500	86,700	107,600	128,000	148,900	165,800
	~280	31,800	49,600	69,200	88,300	110,400	34,800	52,600	72,200	91,300	113,400	134,700	156,800	178,900

※出窓の場合はコーナー1ヶ所につきコード式は3,500円、ドラム式は4,500円プラスになります。

style no.S01 ロールソフト									
スプリング・チェーンタイプ									
H	W	30~60	~80	~100	~120	~140	~160	~180	~190
50~80		30,700	33,200	35,200	36,400	38,100	40,600	43,200	45,700
	~120	33,500	36,600	38,600	39,700	41,600	44,100	46,500	49,100
	~160	36,200	40,000	42,000	43,200	44,500	46,900	49,400	51,900
	~200	40,000	43,000	45,200	46,400	47,700	50,300	52,800	55,300
	~240		46,300	48,600	49,800	51,200	53,700	56,200	58,800

※丈は巾の3倍までが限度です。

※ロールソフト加工品は非防炎品になります。

TM-54339・54340



巾 ◇ 300cm ヨコ使い 価格 ◇ 3,150円/m リピート ◇ タテ cm ヨコ cm 取扱い表示 ◇ リ-30

組成 ◇ ポリエステル100% 寸法変化率 ◇ 水洗い/タテ 0.0% ヨコ 0.0% 防炎性能 ◇ -

ドライ/タテ 0.5% ヨコ 0.5% Made in Turkey あて布使用

H	W	~50 (片開き)	~100	~150	~200	~250	~300	~350	~400
~100	5,300	10,100	15,000	19,800	24,600	29,500	34,300	39,100	
~120	5,700	10,700	15,800	20,900	26,000	31,000	36,100	41,200	
~140	5,900	11,200	16,500	21,800	27,200	32,500	37,800	43,100	
~160	6,200	11,700	17,300	22,800	28,400	33,900	39,500	45,000	
~180	6,400	12,200	18,000	23,800	29,600	35,300	41,100	46,900	
~200	6,600	12,700	18,700	24,700	30,800	36,800	42,800	48,800	
~220	7,000	13,300	19,500	25,800	32,100	38,300	44,600	50,900	
~240	7,200	13,700	20,300	26,800	33,300	39,800	46,300	52,800	
~260	7,500	14,200	21,000	27,700	34,500	41,200	48,000	54,700	
約1.5倍ヒダ	~60	~120	~200	~266	~333	~400	~466	~533	
フラット前ヒダ	~90	~160	~260	~360	~460	~560			

H	W	~50 (片開き)	~100	~150	~200	~250	~300	~350	~400
~100	5,900	11,300	16,700	22,100	27,500	32,900	38,300	43,600	
~120	6,400	12,100	17,800	23,500	29,200	34,900	40,700	46,400	
~140	6,700	12,700	18,800	24,800	30,800	36,900	42,900	48,900	
~160	7,000	13,400	19,700	26,100	32,400	38,800	45,100	51,500	
~180	7,400	14,000	20,700	27,400	34,000	40,700	47,400	54,000	
~200	7,700	14,700	21,700	28,600	35,600	42,600	49,600	56,600	
~220	8,200	15,500	22,800	30,100	37,400	44,700	52,000	59,300	
~240	8,500	16,100	23,700	31,400	39,000	46,600	54,300	61,900	
~260	8,800	16,700	24,700	32,600	40,600	48,500	56,500	64,400	
~280	8,800	16,700	24,700	32,600	40,600	48,500	56,500	64,400	
約1.5倍ヒダ	~60	~120	~200	~266	~333	~400	~466	~533	
フラット前ヒダ	~90	~160	~260	~360	~460	~560			

H	W	~50 (片開き)	~100	~150	~200	~250	~300	~350	~400
~100	5,600	10,700	15,800	20,900	26,100	31,200	36,300	41,400	
~120	6,000	11,400	16,800	22,200	27,600	33,000	38,400	43,800	
~140	6,300	12,000	17,700	23,300	29,000	34,700	40,300	46,000	
~160	6,600	12,500	18,500	24,400	30,400	36,300	42,300	48,200	
~180	6,900	13,100	19,300	25,600	31,800	38,000	44,300	50,500	
~200	7,200	13,700	20,200	26,700	33,200	39,700	46,200	52,700	
~220	7,600	14,400	21,200	27,900	34,700	41,500	48,300	55,100	
~240	7,900	14,900	22,000	29,100	36,100	43,200	50,300	57,300	
~260	8,100	15,500	22,800	30,200	37,500	44,900	52,200	59,600	
約1.5倍ヒダ	~60	~120	~200	~266	~333	~400	~466	~533	

※片開きはW270cmまで

H	W	~50 (片開き)	~100	~150	~200	~250	~300	~350	~400
~100	6,200	11,900	17,600	23,200	28,900	34,600	40,200	45,900	
~120	6,800	12,800	18,800	24,800	30,900	36,900	42,900	49,000	
~140	7,100	13,500	19,900	26,300	32,700	39,100	45,500	51,800	
~160	7,500	14,200	21,000	27,700	34,500	41,200	48,000	54,700	
~180	7,800	14,900	22,100	29,200	36,300	43,400	50,500	57,600	
~200	8,200	15,700	23,100	30,600	38,100	45,500	53,000	60,500	
~220	8,700	16,600	24,400	32,200	40,100	47,900	55,700	63,500	
~240	9,100	17,300	25,500	33,700	41,900	50,000	58,200	66,400	
~260	9,500	18,000	26,600	35,100	43,700	52,200	60,800	69,300	
~280	9,500	18,000	26,600	35,100	43,700	52,200	60,800	69,300	
約1.5倍ヒダ	~60	~120	~200	~266	~333	~400	~466	~533	

※片開きはW270cmまで

H	W	~50 (片開き)	~100	~150	~200	~250	~300	~350	~400
~100	5,900	11,300	16,700	22,100	27,500	32,900	38,300	43,600	
~120	6,400	12,100	17,800	23,500	29,200	34,900	40,700	46,400	
~140	6,700	12,700	18,800	24,800	30,800	36,900	42,900	48,900	
~160	7,000	13,400	19,700	26,100	32,400	38,800	45,100	51,500	
~180	7,400	14,000	20,700	27,400	34,000	40,700	47,400	54,000	
~200	7,700	14,700	21,700	28,600	35,600	42,600	49,600	56,600	
~220	8,200	15,500	22,800	30,100	37,400	44,700	52,000	59,300	
~240	8,500	16,100	23,700	31,400	39,000	46,600	54,300	61,900	
~260	8,800	16,700	24,700	32,600	40,600	48,500	56,500	64,400	
約1.5倍ヒダ	~60	~120	~200	~266	~333	~400	~466	~533	

※片開きはW270cmまで

H	W	~50 (片開き)	~100	~150	~200	~250	~300	~350	~400
~100	6,500	12,500	18,400	24,400	30,300	36,300	42,200	48,200	
~120	7,100	13,500	19,800	26,200	32,500	38,900	45,200	51,600	
~140	7,500	14,300	21,000	27,800	34,500	41,300	48,000	54,800	
~160	7,900	15,100	22,200	29,400	36,500	43,700	50,800	58,000	
~180	8,300	15,900	23,400	31,000	38,500	46,100	53,600	61,200	
~200	8,700	16,700	24,600	32,600	40,500	48,500	56,400	64,400	
~220	9,300	17,700	26,000	34,400	42,700	51,100	59,400	67,800	
~240	9,700	18,500	27,200	36,000	44,700	53,500	62,200	71,000	
~260	10,100	19,300	28,400	37,600	46,700	55,900	65,000	74,200	
約1.5倍ヒダ	~60	~120	~200	~266	~333	~400	~466	~533	

※片開きはW300cmまで

共生地フリル style no.11 (タッセル含む)								
H	W	~80	~120	~160	~200	~240	~280	~320
~100	9,500	12,500						
~120	10,200	13,400	18,100					
~140	10,500	14,500	19,300	24,100				
~160	13,500	19,200	26,100	32,100	37,800			
~180	14,200	20,300	27,300	33,900	39,500	48,000		
~200	15,000	21,200	28,600	34,900	42,600	50,100	57,900	
~220	15,600	22,300	29,900	36,600	43,200	52,400	59,400	
~240	16,500	23,200	31,300	38,100	45,200	54,600	62,100	
~260	17,400	25,600	32,800	39,800	46,900	56,900	63,000	

共生地フリル style no.15 (タッセル含む)				
H	W	~40(1P)	~50(1P)	~60(1P)
~100	11,000	12,500	14,100	
~120	12,000	13,700	15,300	
~140	13,100	14,600	16,500	
~160	15,600	17,700	19,700	
~180	16,700	18,700	20,800	
~200	17,700	19,800	21,700	
~220	18,700	20,700	22,800	
~240	19,900	21,700	23,400	
~260	20,900	22,700	24,200	

H	W	~80	~120	~160	~200	~240	~280	~320
~100	13,300	17,600						
~120	14,200	18,900	24,900					
~140	15,000	20,200	26,500	32,600				
~160	18,100	25,300	33,500	41,100	47,900			
~180	19,200	26,600	35,100	43,000	50,000	60,100		
~200	20,200	27,900	36,700	44,400	53,300	62,700	71,900	
~220	21,200	29,200	38,400	46,400	54,400	65,200	73,900	
~240	22,300	30,500	40,000	48,300	56,500	67,800	76,700	
~260	23,300	33,100	41,600	50,100	58,700	70,300	78,100	

共生地フリル style no.17						
ウェーブ数	3W	4W	5W	6W	7W	
100~130	~160	~190	~240	~290	~330	
80~100	13,000	17,100	20,700	25,500	32,500	37,100
~120	14,800	20,300	24,300	30,200	38,100	43,000
~140	15,600	21,300	25,600	31,800	40,100	45,900
~160	20,400	27,200	32,800	40,900	51,700	59,800
~180	28,200	34,100	42,400	53,700	62,700	
~200		35,300	44,100	55,700	65,700	

共生地フリル style no.19							
ウェーブ数	2W	3W	4W	5W	6W	7W	
60~100	~130	~160	~190	~240	~290	~330	
80~100	10,400	13,000	17,100	20,700	25,500	32,500	37,100
~120	11,900	14,800	20,300	24,300	30,200	38,100	43,000
~140	12,500	15,600	21,300	25,600	31,800	40,100	45,900
~160	20,400	27,200	32,800	40,900	51,700	59,800	
~180	28,200	34,100	42,400	53,700	62,700		
~200		35,300	44,100	55,700	65,700		

style no.60 プレーンシェード														
	コード式					ドラム式								
H	W	30~45	~90	~140	~190	~240	30~45	~90	~140	~190	~240	~290	~340	~390
50~100		13,400	17,400	22,000	26,100	30,800	16,400	20,400	25,000	29,100	33,800	40,900	48,900	53,700
	~140	15,400	19,500	24,200	28,400	33,300	18,400	22,500	27,200	31,400	36,300	43,700	52,900	57,800
	~180	17,300	21,400	26,500	30,700	35,800	20,300	24,400	29,500	33,700	38,800	46,300	56,700	61,700
	~220	19,300	23,500	28,700	33,000	38,300	22,300	26,500	31,700	36,000	41,300	49,000	60,700	65,800
	~260	21,200	25,500	30,900	35,300	40,800	24,200	28,500	33,900	38,300	43,800	51,600	64,700	69,700
	~280	23,200	27,500	33,200	37,500	43,300	26,200	30,500	36,200	40,500	46,300	54,400	68,400	73,800

※ドラム式：仕上り巾39cm以下の場合、仕上り丈は200cmまでとなります。

スリムシェード		コード式
H	W	18~30
50~100		18,100
	~140	20,600
	~180	22,600
	~220	25,100
	~240	26,600

style no.63 シャープシェード														
	コード式					ドラム式								
H	W	30~45	~90	~140	~190	~240	30~45	~90	~140	~190	~240	~290	~340	~390
50~100		16,100	22,400	29,000	35,600	42,000	19,100	25,400	32,000	38,600	45,000	53,200	63,100	69,700
	~140	18,300	25,000	32,100	39,200	46,100	21,300	28,000	35,100	42,200	49,100	57,700	69,100	76,000
	~180	20,500	27,600	35,200	42,700	50,300	23,500	30,600	38,200	45,700	53,300	62,200	75,400	82,700
	~220	22,700	30,200	38,200	46,300	54,400	25,700	33,200	41,200	49,300	57,400	66,700	81,100	88,800
	~260	24,900	33,100	41,700	50,400	59,200	27,900	36,100	44,700	53,400	62,200	72,000	88,100	96,200
	~280	27,300	36,000	45,200	54,400	64,000	30,300	39,000	48,200	57,400	67,000	77,300	95,000	103,700

※ドラム式：仕上り巾39cm以下の場合、仕上り丈は200cmまでとなります。

style no.50 バルーンブレン														
	コード式					ドラム式								
スラッグ数	1S	2S	3S	4S	5S	1S	2S	3S	4S	5S	6S	7S	8S	
H	W	36~50	~100	~150	~200	~250	40~50	~100	~150	~200	~250	~300	~350	~400
100~140		20,400	31,900	44,200	56,500	70,600	23,400	34,900	47,200	59,500	73,600	87,800	101,900	116,000
	~180	22,400	34,700	47,900	61,200	76,400	25,400	37,700	50,900	64,200	79,400	94,600	109,800	125,100
	~220	24,500	37,500	51,600	65,800	82,200	27,500	40,500	54,600	68,800	85,200	101,300	117,800	134,200
	~260	25,700	40,300	55,300	70,300	88,000	28,700	43,300	58,300	73,300	91,000	108,100	125,700	139,400
	~280	28,600	43,100	59,000	74,900	93,800	31,600	46,100	62,000	77,900	96,800	114,800	133,600	152,400

※出窓の場合はコーナー1ヶ所につきコード式は3,500円、ドラム式は4,500円プラスになります。

style no.51 バルーンフリル														
	コード式					ドラム式								
スラッグ数	1S	2S	3S	4S	5S	1S	2S	3S	4S	5S	6S	7S	8S	
H	W	36~50	~100	~150	~200	~250	40~50	~100	~150	~200	~250	~300	~350	~400
100~140		21,100	33,400	46,700	59,800	74,700	24,100	36,400	49,700	62,800	77,700	92,600	107,400	122,300
	~180	23,200	36,200	50,400	64,400	80,400	26,200	39,200	53,400	67,400	83,400	99,400	115,400	131,400
	~220	25,200	39,000	54,100	69,000	86,200	28,200	42,000	57,100	72,000	89,200	106,100	123,300	140,500
	~260	26,500	41,800	57,800	73,600	92,000	29,500	44,800	60,800	76,600	95,000	112,900	131,300	145,700
	~280	29,300	44,600	61,500	78,200	97,800	32,300	47,600	64,500	81,200	100,800	119,600	139,200	158,700

※出窓の場合はコーナー1ヶ所につきコード式は3,500円、ドラム式は4,500円プラスになります。

style no.S01 ロールソフト									
	スプリング・チェーンタイプ								
H	W	30~60	~80	~100	~120	~140	~160	~180	~190
50~80		28,900	31,400	33,400	34,600	36,300	38,800	41,400	43,900
	~120	31,000	34,100	36,100	37,200	39,100	41,600	44,000	46,600
	~160	33,100	36,900	38,900	40,100	41,400	43,800	46,300	48,800
	~200	36,300	39,300	41,500	42,700	44,000	46,600	49,100	51,600
	~240		41,900	44,200	45,400	46,800	49,300	51,800	54,400

※丈は巾の3倍までが限度です。

style no.60 プレーンシェード														
コード式						ドラム式								
H	W	30~45	~90	~140	~190	~240	30~45	~90	~140	~190	~240	~290	~340	~390
50~100		15,400	19,400	24,000	28,100	32,700	18,400	22,400	27,000	31,100	35,700	42,900	53,000	57,800
	~140	18,100	22,200	26,900	31,000	35,900	21,100	25,200	29,900	34,000	38,900	46,400	58,300	63,200
	~180	20,700	24,800	29,800	33,900	39,100	23,700	27,800	32,800	36,900	42,100	49,600	63,400	68,400
	~220	23,400	27,500	32,700	36,900	42,200	26,400	30,500	35,700	39,900	45,200	53,100	68,700	73,800
	~260	26,000	30,200	35,600	39,800	45,400	29,000	33,200	38,600	42,800	48,400	56,300	74,000	79,000
	~280	28,600	32,900	38,500	42,800	48,600	31,600	35,900	41,500	45,800	51,600	59,800	79,200	84,500

※ドラム式：仕上り巾39cm以下の場合、仕上り丈は200cmまでとなります。

スリムシェード		コード式
H	W	18~30
50~100		19,900
	~140	23,100
	~180	25,700
	~220	28,800
	~240	30,700

style no.63 シャープシェード														
コード式						ドラム式								
H	W	30~45	~90	~140	~190	~240	30~45	~90	~140	~190	~240	~290	~340	~390
50~100		18,200	24,500	31,100	37,700	44,100	21,200	27,500	34,100	40,700	47,100	55,300	67,400	73,900
	~140	21,100	27,800	34,900	42,000	48,900	24,100	30,800	37,900	45,000	51,900	60,500	74,800	81,600
	~180	24,000	31,100	38,700	46,200	53,800	27,000	34,100	41,700	49,200	56,800	65,700	82,400	89,700
	~220	26,900	34,400	42,500	50,500	58,600	29,900	37,400	45,500	53,500	61,600	70,900	89,500	97,200
	~260	29,900	38,000	46,600	55,300	64,100	32,900	41,000	49,600	58,300	67,100	76,900	97,900	106,000
	~280	32,900	41,600	50,800	60,100	69,600	35,900	44,600	53,800	63,100	72,600	82,900	106,200	114,900

※ドラム式：仕上り巾39cm以下の場合、仕上り丈は200cmまでとなります。

style no.50 バルーンプレーン														
コード式							ドラム式							
スラッグ数	1S	2S	3S	4S	5S		1S	2S	3S	4S	5S	6S	7S	8S
H	W	36~50	~100	~150	~200	~250	40~50	~100	~150	~200	~250	~300	~350	~400
100~140		22,400	35,900	50,300	64,700	80,800	25,400	38,900	53,300	67,700	83,800	100,000	116,100	132,200
	~180	24,400	38,700	54,000	69,300	86,500	27,400	41,700	57,000	72,300	89,500	106,800	124,000	141,300
	~220	26,500	41,500	57,700	73,900	92,300	29,500	44,500	60,700	76,900	95,300	113,500	132,000	150,400
	~260	27,800	44,300	61,400	78,400	98,100	30,800	47,300	64,400	81,400	101,100	120,300	139,900	155,600
	~280	30,600	47,100	65,100	83,000	103,900	33,600	50,100	68,100	86,000	106,900	127,000	147,800	168,700

※出窓の場合はコーナー1ヶ所につきコード式は3,500円、ドラム式は4,500円プラスになります。

style no.51 バルーンフリル														
コード式							ドラム式							
スラッグ数	1S	2S	3S	4S	5S		1S	2S	3S	4S	5S	6S	7S	8S
H	W	36~50	~100	~150	~200	~250	40~50	~100	~150	~200	~250	~300	~350	~400
100~140		23,600	38,400	54,400	70,000	87,300	26,600	41,400	57,400	73,000	90,300	107,700	125,100	142,400
	~180	25,700	41,200	58,100	74,600	93,100	28,700	44,200	61,100	77,600	96,100	114,500	133,000	151,500
	~220	27,700	44,000	61,800	79,200	98,800	30,700	47,000	64,800	82,200	101,800	121,200	140,900	160,600
	~260	29,000	46,800	65,500	83,700	104,600	32,000	49,800	68,500	86,700	107,600	128,000	148,900	165,800
	~280	31,800	49,600	69,200	88,300	110,400	34,800	52,600	72,200	91,300	113,400	134,700	156,800	178,900

※出窓の場合はコーナー1ヶ所につきコード式は3,500円、ドラム式は4,500円プラスになります。

style no.S01 ロールソフト									
スプリング・チェーンタイプ									
H	W	30~60	~80	~100	~120	~140	~160	~180	~190
50~80		30,700	33,200	35,200	36,400	38,100	40,600	43,200	45,700
	~120	33,500	36,600	38,600	39,700	41,600	44,100	46,500	49,100
	~160	36,200	40,000	42,000	43,200	44,500	46,900	49,400	51,900
	~200	40,000	43,000	45,200	46,400	47,700	50,300	52,800	55,300
	~240		46,300	48,600	49,800	51,200	53,700	56,200	58,800

※丈は巾の3倍までが限度です。

※ロールソフト加工品は非防炎品になります。

TM-54343



巾 ◇ 300cm ヨコ使い 価格 ◇ 9,000円/m リピート ◇ タテ cm ヨコ 12.0cm 取扱い表示 ◇ リ-30
 組成 ◇ ポリエステル100% 寸法変化率 ◇ 水洗い/タテ 0.0% ヨコ -0.2% 防炎性能 ◇ (イ)
 ドライ/タテ 0.0% ヨコ 0.0% Made in Japan

標準仕様 レギュラー縫製仕様価格表 約2倍ヒダ (タッセルなし)

H	W	~50 (片開き)	~100	~150	~200	~250	~300	~350	~400
~100		11,700	22,400	33,100	43,800	54,500	65,100	75,800	86,500
~120		12,100	23,000	33,900	44,900	55,800	66,700	77,600	88,500
~140		12,300	23,500	34,700	45,800	57,000	68,100	79,300	90,500
~160		12,600	24,000	35,400	46,800	58,200	69,600	81,000	92,400
~180		12,800	24,500	36,100	47,700	59,400	71,000	82,700	94,300
~200		13,100	24,900	36,800	48,700	60,600	72,500	84,300	96,200
~220		13,400	25,500	37,700	49,800	61,900	74,000	86,100	98,300
~240		13,700	26,000	38,400	50,700	63,100	75,500	87,800	100,200
~260		13,900	26,500	39,100	51,700	64,300	76,900	89,500	102,100
約1.5倍ヒダ	~60	~120	~200	~266	~333	~400	~466	~533	
フラット前ヒダ	~90	~160	~260	~360	~460	~560			

レギュラー縫製仕様ウエイトテープ巻きロック加工価格表 約2倍ヒダ (タッセルなし)

H	W	~50 (片開き)	~100	~150	~200	~250	~300	~350	~400
~100		12,300	23,600	34,800	46,100	57,300	68,500	79,800	91,000
~120		12,800	24,400	35,900	47,500	59,100	70,600	82,200	93,700
~140		13,100	25,000	36,900	48,800	60,700	72,500	84,400	96,300
~160		13,500	25,700	37,900	50,100	62,300	74,500	86,700	98,900
~180		13,800	26,300	38,800	51,300	63,900	76,400	88,900	101,400
~200		14,100	26,900	39,800	52,600	65,500	78,300	91,100	104,000
~220		14,600	27,700	40,900	54,100	67,200	80,400	93,500	106,700
~240		14,900	28,400	41,900	55,300	68,800	82,300	95,800	109,300
~260		15,200	29,000	42,800	56,600	70,400	84,200	98,000	111,800
~280		15,200	29,000	42,800	56,600	70,400	84,200	98,000	111,800
約1.5倍ヒダ	~60	~120	~200	~266	~333	~400	~466	~533	
フラット前ヒダ	~90	~160	~260	~360	~460	~560			

形態安定加工価格表 約2倍ヒダ (タッセルなし)

H	W	~50 (片開き)	~100	~150	~200	~250	~300	~350	~400
~100		12,000	23,000	34,000	44,900	55,900	66,800	77,800	88,800
~120		12,500	23,700	34,900	46,200	57,400	68,700	79,900	91,100
~140		12,700	24,300	35,800	47,300	58,800	70,300	81,900	93,400
~160		13,000	24,800	36,600	48,400	60,200	72,000	83,800	95,600
~180		13,300	25,400	37,500	49,500	61,600	73,700	85,800	97,900
~200		13,600	25,900	38,300	50,700	63,000	75,400	87,700	100,100
~220		14,000	26,600	39,300	51,900	64,600	77,200	89,800	102,500
~240		14,300	27,200	40,100	53,000	66,000	78,900	91,800	104,700
~260		14,600	27,800	41,000	54,200	67,400	80,600	93,800	107,000
約1.5倍ヒダ	~60	~120	~200	~266	~333	~400	~466	~533	

※片開きはW270cmまで

形態安定加工ウエイトテープ巻きロック加工価格表 約2倍ヒダ (タッセルなし)

H	W	~50 (片開き)	~100	~150	~200	~250	~300	~350	~400
~100		12,600	24,200	35,700	47,200	58,700	70,200	81,800	93,300
~120		13,200	25,100	36,900	48,800	60,700	72,600	84,500	96,300
~140		13,500	25,800	38,000	50,300	62,500	74,700	87,000	99,200
~160		13,900	26,500	39,100	51,700	64,300	76,900	89,500	102,100
~180		14,300	27,200	40,200	53,100	66,100	79,100	92,000	105,000
~200		14,600	27,900	41,300	54,600	67,900	81,200	94,500	107,900
~220		15,200	28,800	42,500	56,200	69,900	83,600	97,200	110,900
~240		15,500	29,600	43,600	57,600	71,700	85,700	99,800	113,800
~260		15,900	30,300	44,700	59,100	73,500	87,900	102,300	116,700
~280		15,900	30,300	44,700	59,100	73,500	87,900	102,300	116,700
約1.5倍ヒダ	~60	~120	~200	~266	~333	~400	~466	~533	

※片開きはW270cmまで

プライム縫製仕様価格表 約2倍ヒダ (タッセルなし)

H	W	~50 (片開き)	~100	~150	~200	~250	~300	~350	~400
~100		12,300	23,600	34,800	46,100	57,300	68,500	79,800	91,000
~120		12,800	24,400	35,900	47,500	59,100	70,600	82,200	93,700
~140		13,100	25,000	36,900	48,800	60,700	72,500	84,400	96,300
~160		13,500	25,700	37,900	50,100	62,300	74,500	86,700	98,900
~180		13,800	26,300	38,800	51,300	63,900	76,400	88,900	101,400
~200		14,100	26,900	39,800	52,600	65,500	78,300	91,100	104,000
~220		14,600	27,700	40,900	54,100	67,200	80,400	93,500	106,700
~240		14,900	28,400	41,900	55,300	68,800	82,300	95,800	109,300
~260		15,200	29,000	42,800	56,600	70,400	84,200	98,000	111,800
約1.5倍ヒダ	~60	~120	~200	~266	~333	~400	~466	~533	

※片開きはW270cmまで

形状記憶加工価格表 約2倍ヒダ (タッセルなし)

H	W	~50 (片開き)	~100	~150	~200	~250	~300	~350	~400
~100		12,900	24,700	36,500	48,300	60,100	71,900	83,700	95,500
~120		13,500	25,700	37,900	50,100	62,300	74,500	86,700	98,900
~140		13,900	26,500	39,100	51,700	64,300	76,900	89,500	102,100
~160		14,300	27,300	40,300	53,300	66,300	79,300	92,300	105,300
~180		14,700	28,100	41,500	54,900	68,300	81,700	95,100	108,500
~200		15,100	28,900	42,700	56,500	70,300	84,100	97,900	111,700
~220		15,700	29,900	44,100	58,300	72,500	86,700	100,900	115,100
~240		16,100	30,700	45,300	59,900	74,500	89,100	103,700	118,300
~260		16,500	31,500	46,500	61,500	76,500	91,500	106,500	121,500
約1.5倍ヒダ	~60	~120	~200	~266	~333	~400	~466	~533	

※片開きはW300cmまで

センタークロス style no.11 (タッセル含む)

H	W	~80	~120	~160	~200	~240	~280	~320
~100		17,100	23,100					
~120		18,200	24,000	32,600				
~140		18,500	25,600	33,800	41,900			
~160		26,400	37,400	50,900	62,100	73,800		
~180		27,100	39,000	52,100	64,300	75,600	91,800	
~200		28,400	39,900	53,900	65,300	79,100	93,800	108,000
~220		29,000	41,400	55,200	67,500	79,700	96,700	109,500
~240		30,300	42,300	57,100	69,000	82,100	98,800	112,700
~260		31,600	45,200	59,000	71,100	83,900	101,600	113,600

セパレート style no.15 (タッセル含む)

H	W	~40(1P)	~50(1P)	~60(1P)
~100		16,600	18,500	21,100
~120		17,600	20,200	22,800
~140		19,200	21,100	24,400
~160		24,500	28,500	31,800
~180		26,100	29,400	33,400
~200		27,100	31,100	34,300
~220		28,500	31,900	35,900
~240		30,200	33,400	36,500
~260		31,200	34,800	37,700

レースフレンジ style no.12 (タッセル含む)

H	W	~80	~120	~160	~200	~240	~280	~320
~100		18,700	25,600					
~120		19,500	26,900	35,700				
~140		20,300	28,200	37,300	46,200			
~160		27,900	40,400	54,100	66,800	78,800		
~180		28,900	41,700	55,700	68,700	80,900	97,500	
~200		30,000	43,000	57,300	70,200	84,200	100,000	115,100
~220		31,000	44,300	59,000	72,100	85,200	102,500	117,100
~240		32,100	45,600	60,600	74,000	87,400	105,100	119,900
~260		33,100	48,200	62,200	75,900	89,600	107,600	121,300

スカラップM型 style no.17

ウェーブ数	3W	4W	5W	6W	7W
100~130	~160	~190	~240	~290	~330
80~100	22,300	28,800	35,200	43,300	55,600
~120	26,400	35,200	42,600	53,100	67,100
~140	27,200	36,300	43,900	54,700	69,100
~160	39,500	52,000	62,800	78,300	99,300
~180	53,000	64,000	79,900	101,400	116,300
~200	65,300	81,500	103,400	119,200	

スカラップW型 style no.19

ウェーブ数	2W	3W	4W	5W	6W	7W
60~100	~130	~160	~190	~240	~290	~330
80~100	17,500	22,300	28,800	35,200	43,300	55,600
~120	20,800	26,400	35,200	42,600	53,100	67,100
~140	21,400	27,200	36,300	43,900	54,700	69,100
~160	39,500	52,000	62,800	78,300	99,300	113,400
~180	53,000	64,000	79,900	101,400	116,300	
~200	65,300	81,500	103,400	119,200		

アーチ style no.26

ウェーブ数	60~100	~130	~160	~190	~240	~290	~330
80~100	16,800	21,600	28,100	33,700	41,800	53,300	60,300
~120							

style no.60 プレーンシェード														
コード式						ドラム式								
H	W	30~45	~90	~140	~190	~240	30~45	~90	~140	~190	~240	~290	~340	~390
50~100		19,600	23,500	28,000	32,000	36,700	22,600	26,500	31,000	35,000	39,700	46,900	61,000	65,800
	~140	23,600	27,500	32,300	36,200	41,200	26,600	30,500	35,300	39,200	44,200	51,700	69,000	73,900
	~180	27,600	31,500	36,500	40,500	45,600	30,600	34,500	39,500	43,500	48,600	56,300	76,800	81,800
	~220	31,600	35,600	40,800	44,800	50,100	34,600	38,600	43,800	47,800	53,100	61,100	84,800	89,900
	~260	35,600	39,600	45,000	49,000	54,500	38,600	42,600	48,000	52,000	57,500	65,700	92,800	97,800
	~280	39,600	43,600	49,300	53,300	59,100	42,600	46,600	52,300	56,300	62,100	70,500	100,600	106,000

※ドラム式：仕上り巾39cm以下の場合、仕上り丈は200cmまでとなります。

スリムシェード		コード式
H	W	18~30
50~100		23,700
	~140	28,100
	~180	31,900
	~220	36,300
	~240	38,800

style no.63 シャープシェード														
コード式						ドラム式								
H	W	30~45	~90	~140	~190	~240	30~45	~90	~140	~190	~240	~290	~340	~390
50~100		22,400	28,700	35,300	41,900	48,300	25,400	31,700	38,300	44,900	51,300	59,500	75,800	82,300
	~140	26,700	33,400	40,500	47,600	54,600	29,700	36,400	43,500	50,600	57,600	66,100	86,000	92,800
	~180	31,000	38,100	45,700	53,300	60,800	34,000	41,100	48,700	56,300	63,800	72,700	96,400	103,700
	~220	35,300	42,900	50,900	58,900	67,000	38,300	45,900	53,900	61,900	70,000	79,300	106,400	114,100
	~260	39,700	47,800	56,500	65,100	74,000	42,700	50,800	59,500	68,100	77,000	86,700	117,500	125,700
	~280	44,100	52,800	62,100	71,300	80,900	47,100	55,800	65,100	74,300	83,900	94,100	128,700	137,300

※ドラム式：仕上り巾39cm以下の場合、仕上り丈は200cmまでとなります。

style no.50 バルーンブレン														
コード式						ドラム式								
スラッグ数	1S	2S	3S	4S	5S	1S	2S	3S	4S	5S	6S	7S	8S	
H	W	36~50	~100	~150	~200	~250	40~50	~100	~150	~200	~250	~300	~350	~400
100~140		26,500	44,000	62,500	80,900	101,000	29,500	47,000	65,500	83,900	104,000	124,300	144,500	164,600
	~180	28,500	46,800	66,100	85,500	106,800	31,500	49,800	69,100	88,500	109,800	131,100	152,400	173,800
	~220	30,600	49,600	69,900	90,100	112,600	33,600	52,600	72,900	93,100	115,600	137,800	160,400	182,900
	~260	31,800	52,400	73,500	94,700	118,400	34,800	55,400	76,500	97,700	121,400	144,600	168,300	188,000
	~280	34,700	55,200	77,300	99,300	124,200	37,700	58,200	80,300	102,300	127,200	151,300	176,200	201,100

※出窓の場合はコーナー1ヶ所につきコード式は3,500円、ドラム式は4,500円プラスになります。

style no.51 バルーンフリル														
コード式						ドラム式								
スラッグ数	1S	2S	3S	4S	5S	1S	2S	3S	4S	5S	6S	7S	8S	
H	W	36~50	~100	~150	~200	~250	40~50	~100	~150	~200	~250	~300	~350	~400
100~140		28,600	48,400	69,700	90,200	112,600	31,600	51,400	72,700	93,200	115,600	138,000	160,300	182,600
	~180	30,700	51,200	73,300	94,800	118,300	33,700	54,200	76,300	97,800	121,300	144,800	168,300	191,800
	~220	32,700	54,000	77,100	99,500	124,100	35,700	57,000	80,100	102,500	127,100	151,500	176,200	200,900
	~260	34,000	56,800	80,700	104,000	129,900	37,000	59,800	83,700	107,000	132,900	158,300	184,100	206,000
	~280	36,800	59,600	84,500	108,600	135,700	39,800	62,600	87,500	111,600	138,700	165,000	192,100	219,100

※出窓の場合はコーナー1ヶ所につきコード式は3,500円、ドラム式は4,500円プラスになります。

TM-54344~54349



巾 ◇ 200cm 価格 ◇ 2,400円/m
組成 ◇ ポリエステル100%

リポート ◇ タテ cm ヨコ cm
寸法変化率 ◇ 水洗い/タテ -0.3% ヨコ -0.1%
ドライ/タテ 0.3% ヨコ -0.3%

取扱い表示 ◇ リ-30
防炎性能 ◇ (イ)
Made in Japan

H	W	~100 1巾(片開き)	~200 2巾	~300 3巾	~400 4巾	~500 5巾	~600 6巾	~700 7巾	~800 8巾
~100	6,800	13,500	20,200	26,900	33,600	40,400	47,100	53,800	
~120	7,700	15,400	23,100	30,800	38,400	46,100	53,800	61,500	
~140	8,700	17,300	26,000	34,600	43,200	51,900	60,500	69,200	
~160	9,600	19,200	28,800	38,400	48,000	57,600	67,200	76,800	
~180	10,600	21,200	31,700	42,300	52,800	63,400	74,000	84,500	
~200	11,600	23,100	34,600	46,100	57,600	69,200	80,700	92,200	
~220	12,500	25,000	37,500	50,000	62,400	74,900	87,400	99,900	
~240	13,500	26,900	40,400	53,800	67,200	80,700	94,100	107,600	
~260	14,400	28,800	43,200	57,600	72,000	86,400	100,800	115,200	
~280	15,400	30,800	46,100	61,500	76,800	92,200	107,600	122,900	
約1.5倍ヒダ	~120	~266	~400	~533	~666	~800	~933	~1066	
フラット前ヒダ	~180	~360	~560	~760					

H	W	~100 1巾(片開き)	~200 2巾	~300 3巾	~400 4巾	~500 5巾
~100	7,300	14,600	21,900	29,200	36,400	
~120	8,400	16,700	25,000	33,300	41,600	
~140	9,400	18,800	28,100	37,500	46,800	
~160	10,400	20,800	31,200	41,600	52,000	
~180	11,500	22,900	34,400	45,800	57,200	
~200	12,500	25,000	37,500	50,000	62,400	
~220	13,600	27,100	40,600	54,100	67,600	
~240	14,600	29,200	43,700	58,300	72,800	
~260	15,600	31,200	46,800	62,400	78,000	
~280	16,700	33,300	50,000	66,600	83,200	
約1.5倍ヒダ	~120	~266	~400	~533		

H	W	~100 1巾(片開き)	~200 2巾	~300 3巾	~400 4巾	~500 5巾
~100	7,900	15,700	23,600	31,400	39,200	
~120	9,000	18,000	26,900	35,900	44,800	
~140	10,100	20,200	30,300	40,400	50,400	
~160	11,200	22,400	33,600	44,800	56,000	
~180	12,400	24,700	37,000	49,300	61,600	
~200	13,500	26,900	40,400	53,800	67,200	
~220	14,600	29,200	43,700	58,300	72,800	
~240	15,700	31,400	47,100	62,800	78,400	
~260	16,800	33,600	50,400	67,200	84,000	
~280	18,000	35,900	53,800	71,700	89,600	
約1.5倍ヒダ	~120	~266	~400	~533		

H	W	~100 1巾(片開き)	~200 2巾	~300 3巾	~400 4巾	~500 5巾	~600 6巾
~100	9,000	18,000	26,900	35,900	44,800	53,800	
~120	10,300	20,500	30,800	41,000	51,200	61,500	
~140	11,600	23,100	34,600	46,100	57,600	69,200	
~160	12,800	25,600	38,400	51,200	64,000	76,800	
~180	14,100	28,200	42,300	56,400	70,400	84,500	
~200	15,400	30,800	46,100	61,500	76,800	92,200	
~220	16,700	33,300	50,000	66,600	83,200	99,900	
~240	18,000	35,900	53,800	71,700	89,600	107,600	
~260	19,200	38,400	57,600	76,800	96,000	115,200	

センタークロス

H	W	~80	~120	~160	~200	~240	~280	~320
~100	9,100	13,100						
~120	10,100	14,900	17,900					
~140	10,800	16,700	20,100	26,800				
~160	11,700	18,500	22,300	29,600	32,000			
~180	12,900	20,100	24,300	32,500	35,100	44,800		
~200	14,000	21,900	26,300	34,600	39,100	48,700	53,100	
~220	15,200	23,700	28,600	37,500	41,000	52,400	56,200	
~240	16,400	25,500	30,700	40,300	44,100	56,400	60,400	
~260	17,600	28,600	32,900	43,000	47,200	60,200	63,200	

H	W	~80	~120	~160	~200	~240	~280	~320
~100	12,600	18,500						
~120	13,700	20,500	24,300					
~140	14,900	22,500	26,700	35,400				
~160	16,000	24,500	29,100	38,500	41,300			
~180	17,400	26,600	31,500	41,500	44,600	56,700		
~200	18,800	28,600	33,800	44,100	49,000	60,900	65,900	
~220	20,200	30,600	36,300	47,200	51,200	65,000	69,500	
~240	21,600	32,700	38,700	50,200	54,500	69,200	73,900	
~260	23,000	36,000	41,100	53,300	57,800	73,300	76,900	

セパレーツ

H	W	~40(1P)	~50(1P)	~60(1P)
~100	12,000	13,200	14,500	
~120	13,600	14,800	16,000	
~140	14,800	16,200	17,600	
~160	16,500	17,900	19,100	
~180	18,000	19,400	20,500	
~200	19,800	21,100	22,200	
~220	21,100	22,300	23,600	
~240	22,600	23,600	24,800	
~260	24,300	25,100	26,100	

スカラップM型

ウェーブ数	3W	4W	5W	6W	7W	
80~100	14,900	18,100	23,800	26,900	35,400	42,400
~120	16,300	20,300	26,600	29,900	39,400	46,700
~140	17,800	22,000	29,000	32,700	43,000	51,600
~160	19,200	23,400	31,100	35,100	46,200	56,200
~180	21,000	25,200	33,500	37,800	49,800	61,100
~200		35,900	40,600	53,400	66,100	

ウェーブ数	3W	4W	5W	6W	7W	
80~100	17,700	21,100	28,300	31,300	41,600	50,300
~120	19,100	23,200	31,100	34,400	45,600	54,500
~140	20,600	25,000	33,500	37,100	49,200	59,400
~160	22,000	26,400	35,500	39,600	52,400	64,000
~180		28,200	37,900	42,300	56,100	68,900
~200		40,400	45,100	59,700	73,900	

スカラップW型

ウェーブ数	2W	3W	4W	5W	6W	7W	
80~100	13,500	14,900	18,100	23,800	26,900	35,400	42,400
~120	14,800	16,300	20,300	26,600	29,900	39,400	46,700
~140	16,100	17,800	22,000	29,000	32,700	43,000	51,600
~160		19,200	23,400	31,100	35,100	46,200	56,200
~180		21,000	25,200	33,500	37,800	49,800	61,100
~200			35,900	40,600	53,400	66,100	

ウェーブ数	2W	3W	4W	5W	6W	7W	
80~100	16,300	17,700	21,100	28,300	31,300	41,600	50,300
~120	17,600	19,100	23,200	31,100	34,400	45,600	54,500
~140	18,900	20,600	25,000	33,500	37,100	49,200	59,400
~160		22,000	26,400	35,500	39,600	52,400	64,000
~180			28,200	37,900	42,300	56,100	68,900
~200			40,400	45,100	59,700	73,900	

アーチ

H	W	60~100	~130	~160	~190	~240	~290	~330
80~100	13,100	14,500	17,700	23,200	26,300	34,600	41,400	
~120	14,400	15,900	19,900	26,000	29,300	38,600	45,700	
~140	15,800	17,400	21,700	28,400	32,100	42,200	50,600	
~160		18,800	23,000	30,500	34,500	45,400	55,200	
~180			24,800	32,900	37,300	49,000	60,100	
~200				35,300	40,000	52,600	65,000	

H	W	60~100	~130	~160	~190	~240	~290	~330
80~100	15,500	16,900	20,200	27,000	30,000	39,800	48,000	
~120	16,800	18,300	22,400	29,800	33,100	43,800	52,200	
~140	18,100	19,800	24,200	32,200	35,900	47,400	57,200	
~160		21,200	25,500	34,200	38,300	50,600	61,700	
~180			27,300	36,700	41,000	54,300	66,600	
~200				39,100	43,800	57,900	71,600	

レース

style no.60 プレーンシェード														
コード式						ドラム式								
H	W	30~45	~90	~140	~190	~240	30~45	~90	~140	~190	~240	~290	~340	~390
50~100		12,600	16,700	21,200	25,300	32,400	15,600	19,700	24,200	28,300	35,400	42,600	47,400	52,200
	~140	14,300	18,400	23,200	27,400	35,500	17,300	21,400	26,200	30,400	38,500	46,000	50,900	55,800
	~180	16,000	20,200	25,200	29,400	38,600	19,000	23,200	28,200	32,400	41,600	49,100	54,100	59,100
	~220	17,700	21,900	27,100	31,500	41,600	20,700	24,900	30,100	34,500	44,600	52,400	57,600	62,700
	~260	19,300	23,700	29,100	33,500	44,700	22,300	26,700	32,100	36,500	47,700	55,600	61,000	66,000
	~300	21,000	25,500	31,100	35,500	47,800	24,000	28,500	34,100	38,500	50,800	58,900	64,300	69,600

※ドラム式：仕上り巾39cm以下の場合、仕上り丈は200cmまでとなります。

スリムシェード		コード式
H	W	18~30
50~100		17,400
	~140	19,600
	~180	21,400
	~220	23,700
	~240	25,000

style no.63 シャープシェード														
コード式						ドラム式								
H	W	30~45	~90	~140	~190	~240	30~45	~90	~140	~190	~240	~290	~340	~390
50~100		15,300	21,600	28,200	34,800	43,800	18,300	24,600	31,200	37,800	46,800	55,000	61,500	68,100
	~140	17,200	23,900	31,000	38,100	48,500	20,200	26,900	34,000	41,100	51,500	60,100	67,000	73,800
	~180	19,100	26,300	33,800	41,400	53,200	22,100	29,300	36,800	44,400	56,200	65,100	72,700	80,000
	~220	21,100	28,600	36,600	44,600	58,000	24,100	31,600	39,600	47,600	61,000	70,200	77,900	85,500
	~260	23,100	31,200	39,800	48,500	63,400	26,100	34,200	42,800	51,500	66,400	76,100	84,300	92,400
	~300	25,100	33,800	43,100	52,300	68,800	28,100	36,800	46,100	55,300	71,800	82,000	90,700	99,300

※ドラム式：仕上り巾39cm以下の場合、仕上り丈は200cmまでとなります。

style no.50 バルーンプレーン														
コード式							ドラム式							
スラッグ数	1S	2S	3S	4S	5S		1S	2S	3S	4S	5S	6S	7S	8S
H	W	36~50	~100	~150	~200	~250	40~50	~100	~150	~200	~250	~300	~350	~400
100~140		20,200	31,500	40,500	52,700	66,500	23,200	34,500	43,500	55,700	69,500	80,500	94,300	105,100
	~180	23,000	35,800	45,700	59,600	75,400	26,000	38,800	48,700	62,600	78,400	90,300	106,100	118,100
	~220	25,800	40,100	51,000	66,500	84,200	28,800	43,100	54,000	69,500	87,200	100,100	117,900	131,100
	~260	27,800	44,500	56,200	73,300	93,100	30,800	47,500	59,200	76,300	96,100	109,900	129,700	140,000
	~300	31,500	48,800	61,500	80,300	101,900	34,500	51,800	64,500	83,300	104,900	119,700	141,400	156,900

※出窓の場合はコーナー1ヶ所につきコード式は3,500円、ドラム式は4,500円プラスになります。

style no.51 バルーンフリル														
コード式							ドラム式							
スラッグ数	1S	2S	3S	4S	5S		1S	2S	3S	4S	5S	6S	7S	8S
H	W	36~50	~100	~150	~200	~250	40~50	~100	~150	~200	~250	~300	~350	~400
100~140		21,100	33,400	43,200	56,300	70,900	24,100	36,400	46,200	59,300	73,900	85,800	100,500	112,200
	~180	23,900	37,700	48,400	63,200	79,800	26,900	40,700	51,400	66,200	82,800	95,700	112,200	125,200
	~220	26,800	42,000	53,700	70,100	88,600	29,800	45,000	56,700	73,100	91,600	105,500	124,000	138,200
	~260	28,800	46,400	58,900	77,000	97,500	31,800	49,400	61,900	80,000	100,500	115,300	135,800	147,100
	~300	32,400	50,700	64,200	83,900	106,400	35,400	53,700	67,200	86,900	109,400	125,100	147,600	164,000

※出窓の場合はコーナー1ヶ所につきコード式は3,500円、ドラム式は4,500円プラスになります。

style no.S01 ロールソフト									
スプリング・チェーンタイプ									
H	W	30~60	~80	~100	~120	~140	~160	~180	~190
50~80		28,200	30,700	32,700	33,900	35,600	38,100	40,700	43,200
	~120	30,000	33,100	35,100	36,200	38,100	40,600	43,000	45,600
	~160	31,900	35,700	37,700	38,900	40,200	42,600	45,100	47,600
	~200	34,900	37,900	40,100	41,300	42,600	45,200	47,700	50,200
	~240		40,200	42,500	43,700	45,100	47,600	50,100	52,700

※丈は巾の3倍までが限度です。

※ロールソフト加工品は非防炎品になります。

TM-54350・54351

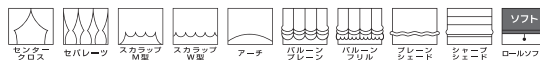

巾 ◇ 200cm 価格 ◇ 2,200円/m
組成 ◇ ポリエステル100%

リポート ◇ タテ cm ヨコ cm
寸法変化率 ◇ 水洗い/タテ 0.0% ヨコ 0.0%
ドライ/タテ 0.0% ヨコ 0.0%

取扱表示 ◇ リ-30
防炎性能 ◇ (イ) あて布使用
Made in Japan

H	W	~100 1巾(片開き)	~200 2巾	~300 3巾	~400 4巾	~500 5巾	~600 6巾	~700 7巾	~800 8巾
~100	6,500	12,900	19,400	25,800	32,200	38,700	45,100	51,600	
~120	7,400	14,800	22,100	29,500	36,800	44,200	51,600	58,900	
~140	8,300	16,600	24,900	33,200	41,400	49,700	58,000	66,300	
~160	9,200	18,400	27,600	36,800	46,000	55,200	64,400	73,600	
~180	10,200	20,300	30,400	40,500	50,600	60,800	70,900	81,000	
~200	11,100	22,100	33,200	44,200	55,200	66,300	77,300	88,400	
~220	12,000	24,000	35,900	47,900	59,800	71,800	83,800	95,700	
~240	12,900	25,800	38,700	51,600	64,400	77,300	90,200	103,100	
~260	13,800	27,600	41,400	55,200	69,000	82,800	96,600	110,400	
~280	14,800	29,500	44,200	58,900	73,600	88,400	103,100	117,800	
約1.5倍ヒダ	~120	~266	~400	~533	~666	~800	~933	~1066	
フラット前ヒダ	~180	~360	~560	~760					

H	W	~100 1巾(片開き)	~200 2巾	~300 3巾	~400 4巾	~500 5巾
~100	7,000	14,000	21,000	28,000	35,000	
~120	8,000	16,000	24,000	32,000	40,000	
~140	9,000	18,000	27,000	36,000	45,000	
~160	10,000	20,000	30,000	40,000	50,000	
~180	11,000	22,000	33,000	44,000	55,000	
~200	12,000	24,000	36,000	48,000	60,000	
~220	13,000	26,000	39,000	52,000	65,000	
~240	14,000	28,000	42,000	56,000	70,000	
~260	15,000	30,000	45,000	60,000	75,000	
~280	16,000	32,000	48,000	64,000	80,000	
約1.5倍ヒダ	~120	~266	~400	~533		

※片開きはW270cmまで

H	W	~100 1巾(片開き)	~200 2巾	~300 3巾	~400 4巾	~500 5巾
~100	7,600	15,200	22,700	30,300	37,800	
~120	8,700	17,300	26,000	34,600	43,200	
~140	9,800	19,500	29,200	38,900	48,600	
~160	10,800	21,600	32,400	43,200	54,000	
~180	11,900	23,800	35,700	47,600	59,400	
~200	13,000	26,000	38,900	51,900	64,800	
~220	14,100	28,100	42,200	56,200	70,200	
~240	15,200	30,300	45,400	60,500	75,600	
~260	16,200	32,400	48,600	64,800	81,000	
~280	17,300	34,600	51,900	69,200	86,400	
約1.5倍ヒダ	~120	~266	~400	~533		

※片開きはW270cmまで

H	W	~100 1巾(片開き)	~200 2巾	~300 3巾	~400 4巾	~500 5巾	~600 6巾
~100	8,700	17,400	26,100	34,800	43,400	52,100	
~120	10,000	19,900	29,800	39,700	49,600	59,600	
~140	11,200	22,400	33,500	44,700	55,800	67,000	
~160	12,400	24,800	37,200	49,600	62,000	74,400	
~180	13,700	27,300	41,000	54,600	68,200	81,900	
~200	14,900	29,800	44,700	59,600	74,400	89,300	
~220	16,200	32,300	48,400	64,500	80,600	96,800	
~240	17,400	34,800	52,100	69,500	86,800	104,200	
~260	18,600	37,200	55,800	74,400	93,000	111,600	

※片開きはW300cmまで

センタークロス

H	W	~80	~120	~160	~200	~240	~280	~320
~100	9,700	12,700						
~120	10,400	13,600	18,400					
~140	10,700	14,800	19,600	24,600				
~160	13,800	19,600	26,700	32,900	38,700			
~180	14,500	20,800	27,900	34,600	40,400	49,100		
~200	15,400	21,700	29,300	35,600	43,500	51,200	59,200	
~220	16,000	22,800	30,500	37,400	44,200	53,600	60,700	
~240	16,900	23,700	32,000	38,900	46,100	55,700	63,400	
~260	17,700	26,100	33,400	40,600	47,900	58,100	64,300	

H	W	~80	~120	~160	~200	~240	~280	~320
~100	13,500	17,800						
~120	14,300	19,100	25,200					
~140	15,100	20,400	26,800	33,000				
~160	18,300	25,700	34,000	41,800	48,700			
~180	19,400	27,000	35,700	43,700	50,800	61,100		
~200	20,400	28,300	37,200	45,100	54,100	63,600	73,000	
~220	21,500	29,500	38,900	47,000	55,100	66,100	75,000	
~240	22,500	30,900	40,500	48,900	57,300	68,700	77,800	
~260	23,500	33,400	42,100	50,800	59,500	71,200	79,200	

セパレーツ

H	W	~40(1P)	~50(1P)	~60(1P)
~100	11,200	12,600	14,300	
~120	12,100	13,800	15,500	
~140	13,300	14,700	16,700	
~160	15,800	18,000	20,000	
~180	17,000	19,000	21,100	
~200	18,000	20,100	22,000	
~220	19,000	20,900	23,200	
~240	20,200	22,000	23,700	
~260	21,100	23,000	24,500	

スカラップM型

ウェーブ数	3W	4W	5W	6W	7W	
80~100	13,200	17,400	21,000	25,900	33,100	37,700
~120	15,100	20,700	24,800	30,800	38,800	43,800
~140	15,900	21,700	26,100	32,400	40,800	46,700
~160	20,900	27,800	33,600	41,800	52,900	61,200
~180	28,800	34,800	43,400	54,900	64,100	
~200		36,100	45,000	56,900	67,000	

ウェーブ数	3W	4W	5W	6W	7W	
80~100	16,900	22,400	26,700	33,400	42,200	48,400
~120	17,600	23,800	28,300	35,300	44,500	50,600
~140	18,400	24,800	29,600	37,000	46,600	53,500
~160	23,300	31,000	37,100	46,400	58,600	68,000
~180		32,000	38,400	48,000	60,700	70,900
~200		39,600	49,600	62,700	73,800	

スカラップW型

ウェーブ数	2W	3W	4W	5W	6W	7W	
80~100	10,500	13,200	17,400	21,000	25,900	33,100	37,700
~120	12,100	15,100	20,700	24,800	30,800	38,800	43,800
~140	12,700	15,900	21,700	26,100	32,400	40,800	46,700
~160	20,900	27,800	33,600	41,800	52,900	61,200	
~180	28,800	34,800	43,400	54,900	64,100		
~200		36,100	45,000	56,900	67,000		

ウェーブ数	2W	3W	4W	5W	6W	7W	
80~100	13,400	16,900	22,400	26,700	33,400	42,200	48,400
~120	14,000	17,600	23,800	28,300	35,300	44,500	50,600
~140	14,600	18,400	24,800	29,600	37,000	46,600	53,500
~160	23,300	31,000	37,100	46,400	58,600	68,000	
~180		32,000	38,400	48,000	60,700	70,900	
~200		39,600	49,600	62,700	73,800		

アーチ

H	W	60~100	~130	~160	~190	~240	~290	~330
80~100	10,300	13,000	17,100	20,500	25,400	32,300	36,900	
~120	11,900	14,900	20,400	24,300	30,200	38,000	43,000	
~140	12,500	15,600	21,400	25,500	31,800	40,000	45,900	
~160		20,600	27,600	33,000	41,300	52,100	60,300	
~180		28,600	34,300	42,900	54,100	63,300		
~200			35,600	44,500	56,100	66,200		

H	W	60~100	~130	~160	~190	~240	~290	~330
80~100	12,900	16,200	21,500	25,600	32,100	40,500	46,400	
~120	13,400	16,900	22,400	26,700	34,000	42,800	48,700	
~140	14,100	17,600	23,900	28,500	35,700	44,900	51,600	
~160		22,600	30,100	36,000	45,100	56,900	66,000	
~180		31,100	37,300	46,700	59,000	68,900		
~200			38,500	48,300	61,000	71,900		

style no.60 プレーンシェード														
	コード式					ドラム式								
H	W	30~45	~90	~140	~190	~240	30~45	~90	~140	~190	~240	~290	~340	~390
50~100		13,500	17,600	22,100	26,200	30,900	16,500	20,600	25,100	29,200	33,900	41,000	49,200	54,000
	~140	15,600	19,700	24,400	28,600	33,500	18,600	22,700	27,400	31,600	36,500	43,900	53,300	58,200
	~180	17,600	21,700	26,700	30,900	36,000	20,600	24,700	29,700	33,900	39,000	46,500	57,200	62,200
	~220	19,600	23,800	29,000	33,300	38,600	22,600	26,800	32,000	36,300	41,600	49,300	61,300	66,400
	~260	21,500	25,900	31,300	35,600	41,100	24,500	28,900	34,300	38,600	44,100	52,000	65,400	70,400
	~280	23,600	28,000	33,600	38,000	43,700	26,600	31,000	36,600	41,000	46,700	54,800	69,200	74,600

※ドラム式：仕上り巾39cm以下の場合、仕上り丈は200cmまでとなります。

スリムシェード		コード式
H	W	18~30
50~100		18,200
	~140	20,800
	~180	22,800
	~220	25,400
	~240	26,900

style no.63 シャープシェード														
	コード式					ドラム式								
H	W	30~45	~90	~140	~190	~240	30~45	~90	~140	~190	~240	~290	~340	~390
50~100		16,300	22,600	29,200	35,800	42,200	19,300	25,600	32,200	38,800	45,200	53,300	63,500	70,000
	~140	18,500	25,200	32,300	39,400	46,300	21,500	28,200	35,300	42,400	49,300	57,900	69,600	76,400
	~180	20,700	27,900	35,400	43,000	50,500	23,700	30,900	38,400	46,000	53,500	62,400	75,900	83,200
	~220	23,000	30,500	38,600	46,600	54,700	26,000	33,500	41,600	49,600	57,700	67,000	81,800	89,400
	~260	25,300	33,500	42,100	50,800	59,600	28,300	36,500	45,100	53,800	62,600	72,400	88,800	97,000
	~280	27,700	36,400	45,700	54,900	64,500	30,700	39,400	48,700	57,900	67,500	77,700	95,900	104,500

※ドラム式：仕上り巾39cm以下の場合、仕上り丈は200cmまでとなります。

style no.50 バルーンブレン														
	コード式					ドラム式								
スラッグ数	1S	2S	3S	4S	5S	1S	2S	3S	4S	5S	6S	7S	8S	
H	W	36~50	~100	~150	~200	~250	40~50	~100	~150	~200	~250	~300	~350	~400
100~140		20,500	32,200	44,700	57,200	71,400	23,500	35,200	47,700	60,200	74,400	88,800	103,000	117,200
	~180	22,600	35,000	48,400	61,800	77,200	25,600	38,000	51,400	64,800	80,200	95,500	110,900	126,400
	~220	24,600	37,800	52,100	66,400	82,900	27,600	40,800	55,100	69,400	85,900	102,300	118,900	135,500
	~260	25,900	40,600	55,800	70,900	88,800	28,900	43,600	58,800	73,900	91,800	109,000	126,800	140,600
	~280	28,700	43,400	59,500	75,500	94,500	31,700	46,400	62,500	78,500	97,500	115,700	134,700	153,700

※出窓の場合はコーナー1ヶ所につきコード式は3,500円、ドラム式は4,500円プラスになります。

style no.51 バルーンフリル														
	コード式					ドラム式								
スラッグ数	1S	2S	3S	4S	5S	1S	2S	3S	4S	5S	6S	7S	8S	
H	W	36~50	~100	~150	~200	~250	40~50	~100	~150	~200	~250	~300	~350	~400
100~140		21,300	33,800	47,300	60,600	75,600	24,300	36,800	50,300	63,600	78,600	93,800	108,800	123,800
	~180	23,400	36,600	51,000	65,200	81,400	26,400	39,600	54,000	68,200	84,400	100,500	116,700	133,000
	~220	25,400	39,400	54,700	69,800	87,200	28,400	42,400	57,700	72,800	90,200	107,300	124,700	142,100
	~260	26,700	42,200	58,400	74,400	93,000	29,700	45,200	61,400	77,400	96,000	114,000	132,600	147,200
	~280	29,500	45,000	62,100	79,000	98,800	32,500	48,000	65,100	82,000	101,800	120,800	140,500	160,300

※出窓の場合はコーナー1ヶ所につきコード式は3,500円、ドラム式は4,500円プラスになります。

style no.S01 ロールソフト									
	スプリング・チェーンタイプ								
H	W	30~60	~80	~100	~120	~140	~160	~180	~190
50~80		29,000	31,500	33,500	34,700	36,400	38,900	41,500	44,000
	~120	31,200	34,300	36,300	37,400	39,300	41,800	44,200	46,800
	~160	33,300	37,100	39,100	40,300	41,600	44,000	46,500	49,000
	~200	36,600	39,600	41,800	43,000	44,300	46,900	49,400	51,900
	~240		42,200	44,500	45,700	47,100	49,600	52,100	54,700

※丈は巾の3倍までが限度です。

※ロールソフト加工品は非防炎品になります。

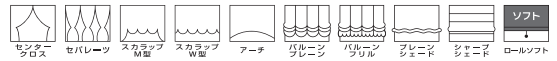

巾 ◇ 300cm ヨコ使い 価格 ◇ 3,300円/m リピート ◇ タテ-cm ヨコ-cm 取扱い表示 ◇ リ-30 40 50 60 70 80 90 100 110 120 130 140 150 160 170 180 190 200 210 220 230 240 250 260 270 280 290 300 310 320 330 340 350 360 370 380 390 400 410 420 430 440 450 460 470 480 490 500 510 520 530 540 550 560 570 580 590 600 610 620 630 640 650 660 670 680 690 700 710 720 730 740 750 760 770 780 790 800 810 820 830 840 850 860 870 880 890 900 910 920 930 940 950 960 970 980 990 1000
組成 ◇ ポリエステル100% 寸法変化率 ◇ 水洗い/タテ 0.0% ヨコ 0.0% 防炎性能 ◇ (イ)
ドライ/タテ 0.0% ヨコ 0.0% Made in Japan

標準仕様 レギュラー縫製仕様価格表 約2倍ヒダ (タッセルなし)
Table with columns H, W, and price ranges from ~50 to ~400.

レギュラー縫製仕様ウエイトテープ巻きロック加工価格表 約2倍ヒダ (タッセルなし)
Table with columns H, W, and price ranges from ~50 to ~400.

形態安定加工価格表 約2倍ヒダ (タッセルなし)
Table with columns H, W, and price ranges from ~50 to ~400.

形態安定加工ウエイトテープ巻きロック加工価格表 約2倍ヒダ (タッセルなし)
Table with columns H, W, and price ranges from ~50 to ~400.

プライム縫製仕様価格表 約2倍ヒダ (タッセルなし)
Table with columns H, W, and price ranges from ~50 to ~400.

形状記憶加工価格表 約2倍ヒダ (タッセルなし)
Table with columns H, W, and price ranges from ~50 to ~400.

センタークロス
共生地フリル style no.11 (タッセル含む)
Table with columns H, W, and price ranges from ~80 to ~320.

セパレート
共生地フリル style no.15 (タッセル含む)
Table with columns H, W, and price ranges from ~40(1P) to ~60(1P).

レースフレンジ style no.12 (タッセル含む)
Table with columns H, W, and price ranges from ~80 to ~320.

スカラップM型
共生地フリル style no.17
Table with columns H, W, and price ranges from ~100-130 to ~330.

スカラップW型
共生地フリル style no.19
Table with columns H, W, and price ranges from ~60-100 to ~330.

アーチ
共生地フリル style no.26
Table with columns H, W, and price ranges from ~60-100 to ~330.

レースフレンジ style no.18
Table with columns H, W, and price ranges from ~100-130 to ~330.

レースフレンジ style no.20
Table with columns H, W, and price ranges from ~60-100 to ~330.

レースフレンジ style no.27
Table with columns H, W, and price ranges from ~60-100 to ~330.

レース

style no.60 プレーンシェード														
	コード式					ドラム式								
H	W	30~45	~90	~140	~190	~240	30~45	~90	~140	~190	~240	~290	~340	~390
50~100		13,500	17,600	22,100	26,200	30,900	16,500	20,600	25,100	29,200	33,900	41,000	49,200	54,000
	~140	15,600	19,700	24,400	28,600	33,500	18,600	22,700	27,400	31,600	36,500	43,900	53,300	58,200
	~180	17,600	21,700	26,700	30,900	36,000	20,600	24,700	29,700	33,900	39,000	46,500	57,200	62,200
	~220	19,600	23,800	29,000	33,300	38,600	22,600	26,800	32,000	36,300	41,600	49,300	61,300	66,400
	~260	21,500	25,900	31,300	35,600	41,100	24,500	28,900	34,300	38,600	44,100	52,000	65,400	70,400
	~280	23,600	28,000	33,600	38,000	43,700	26,600	31,000	36,600	41,000	46,700	54,800	69,200	74,600

※ドラム式：仕上り巾39cm以下の場合、仕上り丈は200cmまでとなります。

スリムシェード		コード式
H	W	18~30
50~100		18,200
	~140	20,800
	~180	22,800
	~220	25,400
	~240	26,900

style no.63 シャープシェード														
	コード式					ドラム式								
H	W	30~45	~90	~140	~190	~240	30~45	~90	~140	~190	~240	~290	~340	~390
50~100		16,300	22,600	29,200	35,800	42,200	19,300	25,600	32,200	38,800	45,200	53,300	63,500	70,000
	~140	18,500	25,200	32,300	39,400	46,300	21,500	28,200	35,300	42,400	49,300	57,900	69,600	76,400
	~180	20,700	27,900	35,400	43,000	50,500	23,700	30,900	38,400	46,000	53,500	62,400	75,900	83,200
	~220	23,000	30,500	38,600	46,600	54,700	26,000	33,500	41,600	49,600	57,700	67,000	81,800	89,400
	~260	25,300	33,500	42,100	50,800	59,600	28,300	36,500	45,100	53,800	62,600	72,400	88,800	97,000
	~280	27,700	36,400	45,700	54,900	64,500	30,700	39,400	48,700	57,900	67,500	77,700	95,900	104,500

※ドラム式：仕上り巾39cm以下の場合、仕上り丈は200cmまでとなります。

style no.50 バルーンプレーン														
	コード式					ドラム式								
スラッグ数	1S	2S	3S	4S	5S	1S	2S	3S	4S	5S	6S	7S	8S	
H	W	36~50	~100	~150	~200	~250	40~50	~100	~150	~200	~250	~300	~350	~400
100~140		20,500	32,200	44,700	57,200	71,400	23,500	35,200	47,700	60,200	74,400	88,800	103,000	117,200
	~180	22,600	35,000	48,400	61,800	77,200	25,600	38,000	51,400	64,800	80,200	95,500	110,900	126,400
	~220	24,600	37,800	52,100	66,400	82,900	27,600	40,800	55,100	69,400	85,900	102,300	118,900	135,500
	~260	25,900	40,600	55,800	70,900	88,800	28,900	43,600	58,800	73,900	91,800	109,000	126,800	140,600
	~280	28,700	43,400	59,500	75,500	94,500	31,700	46,400	62,500	78,500	97,500	115,700	134,700	153,700

※出窓の場合はコーナー1ヶ所につきコード式は3,500円、ドラム式は4,500円プラスになります。

style no.51 バルーンフリル														
	コード式					ドラム式								
スラッグ数	1S	2S	3S	4S	5S	1S	2S	3S	4S	5S	6S	7S	8S	
H	W	36~50	~100	~150	~200	~250	40~50	~100	~150	~200	~250	~300	~350	~400
100~140		21,300	33,800	47,300	60,600	75,600	24,300	36,800	50,300	63,600	78,600	93,800	108,800	123,800
	~180	23,400	36,600	51,000	65,200	81,400	26,400	39,600	54,000	68,200	84,400	100,500	116,700	133,000
	~220	25,400	39,400	54,700	69,800	87,200	28,400	42,400	57,700	72,800	90,200	107,300	124,700	142,100
	~260	26,700	42,200	58,400	74,400	93,000	29,700	45,200	61,400	77,400	96,000	114,000	132,600	147,200
	~280	29,500	45,000	62,100	79,000	98,800	32,500	48,000	65,100	82,000	101,800	120,800	140,500	160,300

※出窓の場合はコーナー1ヶ所につきコード式は3,500円、ドラム式は4,500円プラスになります。

style no.S01 ロールソフト									
	スプリング・チェーンタイプ								
H	W	30~60	~80	~100	~120	~140	~160	~180	~190
50~80		29,000	31,500	33,500	34,700	36,400	38,900	41,500	44,000
	~120	31,200	34,300	36,300	37,400	39,300	41,800	44,200	46,800
	~160	33,300	37,100	39,100	40,300	41,600	44,000	46,500	49,000
	~200	36,600	39,600	41,800	43,000	44,300	46,900	49,400	51,900
	~240		42,200	44,500	45,700	47,100	49,600	52,100	54,700

※丈は巾の3倍までが限度です。

※ロールソフト加工品は非防炎品になります。

TM-54354

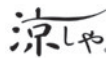

巾 ◇ 100cm 価格 ◇ 1,900円/m
組成 ◇ ポリエステル100%

リポート ◇ タテ cm ヨコ 2.8 cm
寸法変化率 ◇ 水洗い/タテ -0.5% ヨコ -0.3%
ドライ/タテ -1.0% ヨコ -0.8%

取扱い表示 ◇ リ-30
防炎性能 ◇ (イ)
Made in Japan

H	W	~44 1巾(片開き)	~100 2巾	~150 3巾	~200 4巾	~250 5巾	~300 6巾	~350 7巾	~400 8巾
~100		4,400	8,700	13,100	17,400	21,700	26,100	30,400	34,800
~120		5,000	10,000	14,900	19,900	24,800	29,800	34,800	39,700
~140		5,600	11,200	16,800	22,400	27,900	33,500	39,100	44,700
~160		6,200	12,400	18,600	24,800	31,000	37,200	43,400	49,600
~180		6,900	13,700	20,500	27,300	34,100	41,000	47,800	54,600
~200		7,500	14,900	22,400	29,800	37,200	44,700	52,100	59,600
~220		8,100	16,200	24,200	32,300	40,300	48,400	56,500	64,500
~240		8,700	17,400	26,100	34,800	43,400	52,100	60,800	69,500
~260		9,300	18,600	27,900	37,200	46,500	55,800	65,100	74,400
~280		10,000	19,900	29,800	39,700	49,600	59,600	69,500	79,400
約1.5倍ヒダ		~56	~120	~200	~266	~333	~400	~466	~533
フラット縫製		~80	~160	~260	~360	~460	~560		

H	W	~44 1巾(片開き)	~100 2巾	~150 3巾	~200 4巾	~250 5巾	~300 6巾	~350 7巾	~400 8巾
~100		4,700	9,300	13,900	18,500	23,100	27,800	32,400	37,000
~120		5,300	10,600	15,900	21,200	26,400	31,700	37,000	42,300
~140		6,000	11,900	17,900	23,800	29,700	35,700	41,600	47,600
~160		6,600	13,200	19,800	26,400	33,000	39,600	46,200	52,800
~180		7,300	14,600	21,800	29,100	36,300	43,600	50,900	58,100
~200		8,000	15,900	23,800	31,700	39,600	47,600	55,500	63,400
~220		8,600	17,200	25,800	34,400	42,900	51,500	60,100	68,700
~240		9,300	18,500	27,800	37,000	46,200	55,500	64,700	74,000
~260		9,900	19,800	29,700	39,600	49,500	59,400	69,300	79,200
~280		10,600	21,200	31,700	42,300	52,800	63,400	74,000	84,500
約1.5倍ヒダ		~56	~120	~200	~266	~333	~400	~466	~533

H	W	~44 1巾(片開き)	~100 2巾	~150 3巾	~200 4巾	~250 5巾	~300 6巾	~350 7巾	~400 8巾
~100		4,900	9,800	14,700	19,600	24,500	29,400	34,300	39,200
~120		5,600	11,200	16,800	22,400	28,000	33,600	39,200	44,800
~140		6,300	12,600	18,900	25,200	31,500	37,800	44,100	50,400
~160		7,000	14,000	21,000	28,000	35,000	42,000	49,000	56,000
~180		7,700	15,400	23,100	30,800	38,500	46,200	53,900	61,600
~200		8,400	16,800	25,200	33,600	42,000	50,400	58,800	67,200
~220		9,100	18,200	27,300	36,400	45,500	54,600	63,700	72,800
~240		9,800	19,600	29,400	39,200	49,000	58,800	68,600	78,400
~260		10,500	21,000	31,500	42,000	52,500	63,000	73,500	84,000
~280		11,200	22,400	33,600	44,800	56,000	67,200	78,400	89,600
約1.5倍ヒダ		~56	~120	~200	~266	~333	~400	~466	~533

H	W	~44 1巾(片開き)	~100 2巾	~150 3巾	~200 4巾	~250 5巾	~300 6巾	~350 7巾	~400 8巾
~100		5,500	11,000	16,400	21,900	27,300	32,800	38,300	43,700
~120		6,300	12,500	18,800	25,000	31,200	37,500	43,700	50,000
~140		7,100	14,100	21,100	28,100	35,100	42,200	49,200	56,200
~160		7,800	15,600	23,400	31,200	39,000	46,800	54,600	62,400
~180		8,600	17,200	25,800	34,400	42,900	51,500	60,100	68,700
~200		9,400	18,800	28,100	37,500	46,800	56,200	65,600	74,900
~220		10,200	20,300	30,500	40,600	50,700	60,900	71,000	81,200
~240		11,000	21,900	32,800	43,700	54,600	65,600	76,500	87,400
~260		11,700	23,400	35,100	46,800	58,500	70,200	81,900	93,600

		コード式				ドラム式								
H	W	30~45	~90	~140	~190	30~45	~90	~140	~190	~240	~290	~340	~390	
50~100		12,100	16,100	22,700	26,700	33,300	15,100	19,100	25,700	29,700	36,300	43,500	50,300	55,100
~140		13,600	17,800	25,100	29,300	36,700	16,600	20,800	28,100	32,300	39,700	47,200	54,700	59,600
~180		15,100	19,300	27,600	31,800	40,100	18,100	22,300	30,600	34,800	43,100	50,700	58,900	63,900
~220		16,600	20,900	30,000	34,300	43,500	19,600	23,900	33,000	37,300	46,500	54,300	63,300	68,500
~260		18,100	22,500	32,500	36,800	46,800	21,100	25,500	35,500	39,800	49,800	57,700	67,800	72,800
~300		19,600	24,100	35,000	39,300	50,200	22,600	27,100	38,000	42,300	53,200	61,400	72,000	77,400

		コード式
H	W	18~30
50~100		16,900
~140		19,000
~180		20,600
~220		22,700
~240		24,000

		コード式					ドラム式							
スワッグ数		1S	2S	3S	4S	5S	1S	2S	3S	4S	5S	6S	7S	8S
100~140		36~50	~100	~150	~200	~250	40~50	~100	~150	~200	~250	~300	~350	~400
~180		22,000	32,600	44,100	55,600	71,300	25,000	35,600	47,100	58,600	74,300	87,600	100,900	114,100
~220		25,200	37,200	50,200	63,200	81,300	28,200	40,200	53,200	66,200	84,300	99,300	114,300	129,300
~260		28,500	41,900	56,400	70,900	91,300	31,500	44,900	59,400	73,900	94,300	110,800	127,700	144,500
~300		31,000	46,500	62,500	78,500	101,400	34,000	49,500	65,500	81,500	104,400	122,500	141,100	155,700
~300		35,000	51,100	68,600	86,100	111,400	38,000	54,100	71,600	89,100	114,400	134,100	154,500	174,900

※ 出窓の場合はコーナー1ヶ所につきコード式は3,500円、ドラム式は4,500円プラスになります。

		スプリング・チェーンタイプ		
H	W	30~60	~80	~90
50~80		27,700	30,200	32,200
~120		29,400	32,500	34,500
~160		31,100	34,900	36,900
~200		33,900	36,900	39,100
~240			39,100	41,400

※ 丈は巾の3倍までが限度です。
※ ロールソフト加工品は非防炎品になります。

TM-54355

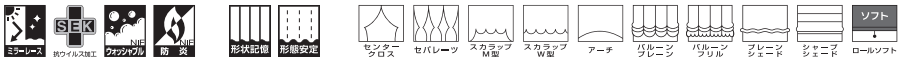

巾 ◇ 100cm 価格 ◇ 1,900円/m
組成 ◇ ポリエステル100%

リポート ◇ タテcm ヨコcm
寸法変化率 ◇ 水洗い/タテ 0.0% ヨコ -0.7%
ドライ/タテ -1.0% ヨコ -1.0%

取扱い表示 ◇ リ-30 40
防炎性能 ◇ (イ) あて布使用
Made in Japan

H \ W	~44 1巾(片開き)	~100 2巾	~150 3巾	~200 4巾	~250 5巾	~300 6巾	~350 7巾	~400 8巾
~100	4,400	8,700	13,100	17,400	21,700	26,100	30,400	34,800
~120	5,000	10,000	14,900	19,900	24,800	29,800	34,800	39,700
~140	5,600	11,200	16,800	22,400	27,900	33,500	39,100	44,700
~160	6,200	12,400	18,600	24,800	31,000	37,200	43,400	49,600
~180	6,900	13,700	20,500	27,300	34,100	41,000	47,800	54,600
~200	7,500	14,900	22,400	29,800	37,200	44,700	52,100	59,600
~220	8,100	16,200	24,200	32,300	40,300	48,400	56,500	64,500
~240	8,700	17,400	26,100	34,800	43,400	52,100	60,800	69,500
~260	9,300	18,600	27,900	37,200	46,500	55,800	65,100	74,400
~280	10,000	19,900	29,800	39,700	49,600	59,600	69,500	79,400
約1.5倍ヒダ	~56	~120	~200	~266	~333	~400	~466	~533
フラット前1倍ヒダ	~80	~160	~260	~360	~460	~560		

H \ W	~44 1巾(片開き)	~100 2巾	~150 3巾	~200 4巾	~250 5巾	~300 6巾	~350 7巾	~400 8巾
~100	4,700	9,300	13,900	18,500	23,100	27,800	32,400	37,000
~120	5,300	10,600	15,900	21,200	26,400	31,700	37,000	42,300
~140	6,000	11,900	17,900	23,800	29,700	35,700	41,600	47,600
~160	6,600	13,200	19,800	26,400	33,000	39,600	46,200	52,800
~180	7,300	14,600	21,800	29,100	36,300	43,600	50,900	58,100
~200	8,000	15,900	23,800	31,700	39,600	47,600	55,500	63,400
~220	8,600	17,200	25,800	34,400	42,900	51,500	60,100	68,700
~240	9,300	18,500	27,800	37,000	46,200	55,500	64,700	74,000
~260	9,900	19,800	29,700	39,600	49,500	59,400	69,300	79,200
~280	10,600	21,200	31,700	42,300	52,800	63,400	74,000	84,500
約1.5倍ヒダ	~56	~120	~200	~266	~333	~400	~466	~533

※片開きはW270cmまで

H \ W	~44 1巾(片開き)	~100 2巾	~150 3巾	~200 4巾	~250 5巾	~300 6巾	~350 7巾	~400 8巾
~100	4,900	9,800	14,700	19,600	24,500	29,400	34,300	39,200
~120	5,600	11,200	16,800	22,400	28,000	33,600	39,200	44,800
~140	6,300	12,600	18,900	25,200	31,500	37,800	44,100	50,400
~160	7,000	14,000	21,000	28,000	35,000	42,000	49,000	56,000
~180	7,700	15,400	23,100	30,800	38,500	46,200	53,900	61,600
~200	8,400	16,800	25,200	33,600	42,000	50,400	58,800	67,200
~220	9,100	18,200	27,300	36,400	45,500	54,600	63,700	72,800
~240	9,800	19,600	29,400	39,200	49,000	58,800	68,600	78,400
~260	10,500	21,000	31,500	42,000	52,500	63,000	73,500	84,000
~280	11,200	22,400	33,600	44,800	56,000	67,200	78,400	89,600
約1.5倍ヒダ	~56	~120	~200	~266	~333	~400	~466	~533

※片開きはW270cmまで

H \ W	~44 1巾(片開き)	~100 2巾	~150 3巾	~200 4巾	~250 5巾	~300 6巾	~350 7巾	~400 8巾
~100	5,500	11,000	16,400	21,900	27,300	32,800	38,300	43,700
~120	6,300	12,500	18,800	25,000	31,200	37,500	43,700	50,000
~140	7,100	14,100	21,100	28,100	35,100	42,200	49,200	56,200
~160	7,800	15,600	23,400	31,200	39,000	46,800	54,600	62,400
~180	8,600	17,200	25,800	34,400	42,900	51,500	60,100	68,700
~200	9,400	18,800	28,100	37,500	46,800	56,200	65,600	74,900
~220	10,200	20,300	30,500	40,600	50,700	60,900	71,000	81,200
~240	11,000	21,900	32,800	43,700	54,600	65,600	76,500	87,400
~260	11,700	23,400	35,100	46,800	58,500	70,200	81,900	93,600

※片開きはW300cmまで

センタークロス

H \ W	~80	~120	~160	~200	~240	~280	~320
~100	11,100	14,500					
~120	12,400	16,600	22,300				
~140	13,600	18,600	25,000	30,900			
~160	14,700	20,500	27,800	34,200	39,800		
~180	16,200	22,600	30,300	37,500	43,700	52,900	
~200	17,700	24,600	32,900	40,200	48,500	57,500	65,900
~220	19,000	26,400	35,700	43,600	51,200	62,000	70,100
~240	20,500	28,500	38,300	46,800	55,100	66,700	75,400
~260	22,000	31,800	41,000	49,900	58,800	71,300	79,200

セバレーツ

H \ W	~40(1P)	~50(1P)	~60(1P)
~100	12,100	15,400	16,700
~120	13,700	17,400	18,700
~140	15,200	19,300	20,600
~160	16,700	21,100	22,400
~180	18,200	23,100	24,300
~200	20,000	25,000	26,300
~220	21,200	26,800	28,100
~240	22,700	28,400	29,500
~260	24,400	30,300	31,100

レースフレンジ style no.12 (タッセル含む)

H \ W	~80	~120	~160	~200	~240	~280	~320
~100	13,700	18,100					
~120	15,100	20,300	27,100				
~140	16,500	22,500	29,900	37,000			
~160	17,800	24,600	32,900	40,400	46,900		
~180	19,400	26,800	35,700	43,800	50,900	61,400	
~200	21,000	28,900	38,500	46,800	55,900	66,100	75,600
~220	22,600	31,100	41,400	50,200	58,800	70,900	80,100
~240	24,300	33,300	44,200	53,600	62,800	75,700	85,500
~260	25,900	36,700	47,000	57,000	66,800	80,500	89,500

スカラップM型

ウェーブ数	3W	4W	5W	6W	7W	
H \ W	100~130	~160	~190	~240	~290	~330
80~100	18,900	22,400	27,300	33,200	44,300	50,600
~120	20,700	25,000	30,500	37,000	49,300	55,700
~140	22,700	27,200	33,300	40,400	53,800	61,500
~160	24,500	29,000	35,700	43,500	57,900	66,900
~180		31,200	38,500	46,900	62,500	72,700
~200			41,200	50,300	67,100	78,500

スカラップW型

ウェーブ数	2W	3W	4W	5W	6W	7W	
H \ W	60~100	~130	~160	~190	~240	~290	~330
80~100	14,800	18,900	22,400	27,300	33,200	44,300	50,600
~120	16,200	20,700	25,000	30,500	37,000	49,300	55,700
~140	17,700	22,700	27,200	33,300	40,400	53,800	61,500
~160		24,500	29,000	35,700	43,500	57,900	66,900
~180			31,200	38,500	46,900	62,500	72,700
~200				41,200	50,300	67,100	78,500

アーチ

H \ W	60~100	~130	~160	~190	~240	~290	~330
80~100	14,300	18,300	21,700	26,500	32,300	43,000	49,100
~120	15,800	20,200	24,400	29,700	36,100	48,000	54,300
~140	17,300	22,100	26,600	32,500	39,500	52,500	60,000
~160		24,000	28,400	34,900	42,600	56,600	65,400
~180			30,600	37,700	46,000	61,200	71,200
~200				40,500	49,400	65,800	77,000

レースフレンジ style no.18

ウェーブ数	3W	4W	5W	6W	7W	
H \ W	100~130	~160	~190	~240	~290	~330
80~100	20,000	23,500	28,800	35,000	46,800	53,400
~120	21,900	26,200	32,000	38,700	51,700	58,500
~140	23,800	28,400	34,700	42,200	56,300	64,300
~160	25,700	30,200	37,200	45,300	60,400	69,700
~180		32,400	39,900	48,700	65,000	75,500
~200			42,700	52,100	69,600	81,300

レースフレンジ style no.20

ウェーブ数	2W	3W	4W	5W	6W	7W	
H \ W	60~100	~130	~160	~190	~240	~290	~330
80~100	15,600	20,000	23,500	28,800	35,000	46,800	53,400
~120	17,100	21,900	26,200	32,000	38,700	51,700	58,500
~140	18,500	23,800	28,400	34,700	42,200	56,300	64,300
~160		25,700	30,200	37,200	45,300	60,400	69,700
~180			32,400	39,900	48,700	65,000	75,500
~200				42,700	52,100	69,600	81,300

レースフレンジ style no.27

H \ W	60~100	~130	~160	~190	~240	~290	~330
80~100	15,000	19,200	22,700	27,700	33,700	45,000	51,300
~120	16,400	21,100	25,300	30,900	37,400	49,500	56,400
~140	17,900	23,000	27,500	33,700	40,900	54,500	62,000
~160		24,800	29,300	36,100	44,000	58,600	67,600
~180			31,600	38,900	47,400	63,200	73,400
~200				41,600	50,800	67,700	79,200

style no.60 プレーンシェード														
コード式					ドラム式									
H	W	30~45	~90	~140	~190	~240	30~45	~90	~140	~190	~240	~290	~340	~390
50~100		12,100	16,100	22,700	26,700	33,300	15,100	19,100	25,700	29,700	36,300	43,500	50,300	55,100
	~140	13,600	17,800	25,100	29,300	36,700	16,600	20,800	28,100	32,300	39,700	47,200	54,700	59,600
	~180	15,100	19,300	27,600	31,800	40,100	18,100	22,300	30,600	34,800	43,100	50,700	58,900	63,900
	~220	16,600	20,900	30,000	34,300	43,500	19,600	23,900	33,000	37,300	46,500	54,300	63,300	68,500
	~260	18,100	22,500	32,500	36,800	46,800	21,100	25,500	35,500	39,800	49,800	57,700	67,800	72,800
	~300	19,600	24,100	35,000	39,300	50,200	22,600	27,100	38,000	42,300	53,200	61,400	72,000	77,400

※ドラム式：仕上り巾39cm以下の場合、仕上り丈は200cmまでとなります。

スリムシェード	
コード式	
H	W
50~100	18~30
	16,900
	~140
	19,000
	~180
	20,600
	~220
	22,700
	~240
	24,000

style no.63 シャープシェード														
コード式					ドラム式									
H	W	30~45	~90	~140	~190	~240	30~45	~90	~140	~190	~240	~290	~340	~390
50~100		14,800	21,100	29,700	36,300	44,700	17,800	24,100	32,700	39,300	47,700	55,900	64,500	71,100
	~140	16,500	23,200	33,000	40,100	49,800	19,500	26,200	36,000	43,100	52,800	61,300	71,000	77,900
	~180	18,200	25,400	36,300	43,900	54,900	21,200	28,400	39,300	46,900	57,900	66,800	77,700	85,000
	~220	20,000	27,500	39,600	47,700	59,900	23,000	30,500	42,600	50,700	62,900	72,200	83,900	91,600
	~260	21,800	29,900	43,400	52,000	65,600	24,800	32,900	46,400	55,000	68,600	78,400	91,300	99,500
	~300	23,700	32,400	47,100	56,300	71,400	26,700	35,400	50,100	59,300	74,400	84,600	98,700	107,400

※ドラム式：仕上り巾39cm以下の場合、仕上り丈は200cmまでとなります。

style no.50 バルーンブレン														
コード式					ドラム式									
スワッグ数		1S	2S	3S	4S	5S	1S	2S	3S	4S	5S	6S	7S	8S
H	W	36~50	~100	~150	~200	~250	40~50	~100	~150	~200	~250	~300	~350	~400
100~140		22,000	32,600	44,100	55,600	71,300	25,000	35,600	47,100	58,600	74,300	87,600	100,900	114,100
	~180	25,200	37,200	50,200	63,200	81,300	28,200	40,200	53,200	66,200	84,300	99,300	114,300	129,300
	~220	28,500	41,900	56,400	70,900	91,300	31,500	44,900	59,400	73,900	94,300	110,800	127,700	144,500
	~260	31,000	46,500	62,500	78,500	101,400	34,000	49,500	65,500	81,500	104,400	122,500	141,100	155,700
	~300	35,000	51,100	68,600	86,100	111,400	38,000	54,100	71,600	89,100	114,400	134,100	154,500	174,900

※出窓の場合はコーナー1ヶ所につきコード式は3,500円、ドラム式は4,500円プラスになります。

style no.51 バルーンフリル														
コード式					ドラム式									
スワッグ数		1S	2S	3S	4S	5S	1S	2S	3S	4S	5S	6S	7S	8S
H	W	36~50	~100	~150	~200	~250	40~50	~100	~150	~200	~250	~300	~350	~400
100~140		23,500	35,500	48,400	61,200	78,300	26,500	38,500	51,400	64,200	81,300	96,000	110,600	125,200
	~180	26,700	40,100	54,500	68,900	88,300	29,700	43,100	57,500	71,900	91,300	107,600	124,000	140,400
	~220	30,000	44,700	60,600	76,500	98,300	33,000	47,700	63,600	79,500	101,300	119,200	137,400	155,600
	~260	32,500	49,400	66,700	84,100	108,400	35,500	52,400	69,700	87,100	111,400	130,800	150,800	166,800
	~300	36,600	54,000	72,900	91,800	118,400	39,600	57,000	75,900	94,800	121,400	142,400	164,200	186,000

※出窓の場合はコーナー1ヶ所につきコード式は3,500円、ドラム式は4,500円プラスになります。

style no.S01 ロールソフト				
スプリング・チェーンタイプ				
H	W	30~60	~80	~90
50~80		27,700	30,200	32,200
	~120	29,400	32,500	34,500
	~160	31,100	34,900	36,900
	~200	33,900	36,900	39,100
	~240		39,100	41,400

※丈は巾の3倍までが限度です。
 ※ロールソフト加工品は非防災品になります。

TM-54356

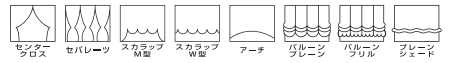

巾 ◇ 100cm 価格 ◇ 1,300円/m
組成 ◇ ポリエステル100%

リポート ◇ タテcm ヨコcm
寸法変化率 ◇ 水洗い/タテ -0.3% ヨコ -0.3%
ドライ/タテ -0.3% ヨコ 0.0%

取扱い表示 ◇ リ-30 40 炎 1 2 3 4 5 6 7 8 9 10
防炎性能 ◇ (イ) あて布使用
Made in Japan

標準仕様		レギュラー縫製仕様価格表 約2倍ヒダ (タッセルなし)							
H	W	~44 1巾(片開き)	~100 2巾	~150 3巾	~200 4巾	~250 5巾	~300 6巾	~350 7巾	~400 8巾
~100		3,500	7,000	10,500	14,000	17,500	21,000	24,500	28,000
~120		4,000	8,000	12,000	16,000	20,000	24,000	28,000	32,000
~140		4,500	9,000	13,500	18,000	22,500	27,000	31,500	36,000
~160		5,000	10,000	15,000	20,000	25,000	30,000	35,000	40,000
~180		5,500	11,000	16,500	22,000	27,500	33,000	38,500	44,000
~200		6,000	12,000	18,000	24,000	30,000	36,000	42,000	48,000
~220		6,500	13,000	19,500	26,000	32,500	39,000	45,500	52,000
~240		7,000	14,000	21,000	28,000	35,000	42,000	49,000	56,000
~260		7,500	15,000	22,500	30,000	37,500	45,000	52,500	60,000
~280		8,000	16,000	24,000	32,000	40,000	48,000	56,000	64,000
約1.5倍ヒダ		~56	~120	~200	~266	~333	~400	~466	~533
フラット約1倍ヒダ		~80	~160	~260	~360	~460	~560		

形態安定加工価格表 約2倍ヒダ (タッセルなし)									
H	W	~44 1巾(片開き)	~100 2巾	~150 3巾	~200 4巾	~250 5巾	~300 6巾	~350 7巾	~400 8巾
~100		3,800	7,600	11,400	15,200	19,000	22,700	26,500	30,300
~120		4,400	8,700	13,000	17,300	21,600	26,000	30,300	34,600
~140		4,900	9,800	14,600	19,500	24,300	29,200	34,100	38,900
~160		5,400	10,800	16,200	21,600	27,000	32,400	37,800	43,200
~180		6,000	11,900	17,900	23,800	29,700	35,700	41,600	47,600
~200		6,500	13,000	19,500	26,000	32,400	38,900	45,400	51,900
~220		7,100	14,100	21,100	28,100	35,100	42,200	49,200	56,200
~240		7,600	15,200	22,700	30,300	37,800	45,400	53,000	60,500
~260		8,100	16,200	24,300	32,400	40,500	48,600	56,700	64,800
~280		8,700	17,300	26,000	34,600	43,200	51,900	60,500	69,200
約1.5倍ヒダ		~56	~120	~200	~266	~333	~400	~466	~533

プライム縫製仕様価格表 約2倍ヒダ (タッセルなし)									
H	W	~44 1巾(片開き)	~100 2巾	~150 3巾	~200 4巾	~250 5巾	~300 6巾	~350 7巾	~400 8巾
~100		4,100	8,200	12,200	16,300	20,300	24,400	28,500	32,500
~120		4,700	9,300	14,000	18,600	23,200	27,900	32,500	37,200
~140		5,300	10,500	15,700	20,900	26,100	31,400	36,600	41,800
~160		5,800	11,600	17,400	23,200	29,000	34,800	40,600	46,400
~180		6,400	12,800	19,200	25,600	31,900	38,300	44,700	51,100
~200		7,000	14,000	20,900	27,900	34,800	41,800	48,800	55,700
~220		7,600	15,100	22,700	30,200	37,700	45,300	52,800	60,400
~240		8,200	16,300	24,400	32,500	40,600	48,800	56,900	65,000
~260		8,700	17,400	26,100	34,800	43,500	52,200	60,900	69,600
~280		9,300	18,600	27,900	37,200	46,400	55,700	65,000	74,300
約1.5倍ヒダ		~56	~120	~200	~266	~333	~400	~466	~533

形状記憶加工価格表 約2倍ヒダ (タッセルなし)									
H	W	~44 1巾(片開き)	~100 2巾	~150 3巾	~200 4巾	~250 5巾	~300 6巾	~350 7巾	~400 8巾
~100		4,700	9,300	13,900	18,500	23,100	27,800	32,400	37,000
~120		5,300	10,600	15,900	21,200	26,400	31,700	37,000	42,300
~140		6,000	11,900	17,900	23,800	29,700	35,700	41,600	47,600
~160		6,600	13,200	19,800	26,400	33,000	39,600	46,200	52,800
~180		7,300	14,600	21,800	29,100	36,300	43,600	50,900	58,100
~200		8,000	15,900	23,800	31,700	39,600	47,600	55,500	63,400
~220		8,600	17,200	25,800	34,400	42,900	51,500	60,100	68,700
~240		9,300	18,500	27,800	37,000	46,200	55,500	64,700	74,000
~260		9,900	19,800	29,700	39,600	49,500	59,400	69,300	79,200

センタークロス								
共生地フリル style no.11 (タッセル含む)								
H	W	~80	~120	~160	~200	~240	~280	~320
~100		9,300	12,100					
~120		10,300	13,700	18,500				
~140		11,300	15,400	20,700	25,800			
~160		12,100	17,000	23,000	28,500	33,100		
~180		13,300	18,700	25,100	31,200	36,200	43,900	
~200		14,600	20,300	27,300	33,400	40,400	47,700	54,800
~220		15,700	21,900	29,600	36,100	42,500	51,500	58,200
~240		16,900	23,600	31,700	38,800	45,700	55,300	62,500
~260		18,100	26,500	33,900	41,400	48,800	59,100	65,500
レースフレンジ style no.12 (タッセル含む)		~80	~120	~160	~200	~240	~280	~320
~100		12,600	16,500					
~120		13,900	18,400	24,500				
~140		15,000	20,300	27,000	33,200			
~160		16,200	22,200	29,500	36,200	41,800		
~180		17,600	24,100	31,900	39,100	45,200	54,500	
~200		19,100	26,000	34,300	41,600	49,700	58,600	66,900
~220		20,500	27,800	36,800	44,600	52,100	62,600	70,700
~240		21,900	29,800	39,300	47,500	55,400	66,700	75,200
~260		23,400	32,900	41,800	50,400	58,900	70,800	78,400

セバレーツ				
共生地フリル style no.15 (タッセル含む)				
H	W	~40(1P)	~50(1P)	~60(1P)
~100		10,800	13,400	14,700
~120		12,200	15,100	16,300
~140		13,500	16,700	17,900
~160		14,800	18,200	19,500
~180		16,200	19,900	21,100
~200		17,700	21,500	22,700
~220		18,700	22,900	24,200
~240		20,100	24,300	25,400
~260		21,600	25,800	26,600

スカラップM型						
共生地フリル style no.17						
ウェーブ数	3W	4W	5W	6W	7W	
80~100	15,400	18,700	22,700	27,800	36,700	42,000
~120	16,900	20,900	25,400	30,900	40,800	46,200
~140	18,500	22,800	27,700	33,800	44,500	51,000
~160	20,000	24,200	29,700	36,300	47,800	55,500
~180	26,100	32,000	39,100	51,600	60,400	
~200		34,300	42,000	55,400	65,300	
レースフレンジ style no.18		~4W	~5W	~6W	~7W	
80~100	18,000	21,400	26,100	31,800	42,400	48,400
~120	19,500	23,700	28,800	35,000	46,500	52,600
~140	21,000	25,500	31,100	37,900	50,300	57,500
~160	22,600	26,900	33,100	40,400	53,600	62,000
~180	28,800	35,400	43,200	57,300	66,800	
~200		37,700	46,100	61,100	71,800	

スカラップW型							
共生地フリル style no.19							
ウェーブ数	2W	3W	4W	5W	6W	7W	
80~100	12,200	15,400	18,700	22,700	27,800	36,700	42,000
~120	13,300	16,900	20,900	25,400	30,900	40,800	46,200
~140	14,500	18,500	22,800	27,700	33,800	44,500	51,000
~160	20,000	24,200	29,700	36,300	47,800	55,500	
~180	26,100	32,000	39,100	51,600	60,400		
~200		34,300	42,000	55,400	65,300		
レースフレンジ style no.20		~2W	~3W	~4W	~5W	~6W	~7W
80~100	14,100	18,000	21,400	26,100	31,800	42,400	48,400
~120	15,300	19,500	23,700	28,800	35,000	46,500	52,600
~140	16,500	21,000	25,500	31,100	37,900	50,300	57,500
~160	22,600	26,900	33,100	40,400	53,600	62,000	
~180	28,800	35,400	43,200	57,300	66,800		
~200		37,700	46,100	61,100	71,800		

アーチ								
共生地フリル style no.26								
H	W	60~100	~130	~160	~190	~240	~290	~330
80~100		11,900	15,000	18,300	22,200	27,100	35,800	41,000
~120		13,000	16,500	20,500	24,900	30,300	39,900	45,200
~140		14,200	18,100	22,400	27,200	33,200	43,700	50,100
~160		19,600	23,800	29,200	35,700	47,000	54,600	
~180		25,600	31,500	38,500	50,800	59,400		
~200			33,800	41,400	54,500	64,300		
レースフレンジ style no.27		~60~100	~130	~160	~190	~240	~290	~330
80~100		13,500	17,200	20,600	25,100	30,500	40,600	46,300
~120		14,700	18,700	22,800	27,800	33,700	44,700	50,500
~140		15,900	20,200	24,600	30,100	36,600	48,400	55,400
~160		21,700	26,100	32,000	39,100	51,700	59,900	
~180		27,900	34,300	41,900	55,500	64,800		
~200			36,600	44,800	59,300	69,700		

style no.60 プレーンシェード														
		コード式					ドラム式							
H	W	30~45	~90	~140	~190	~240	30~45	~90	~140	~190	~240	~290	~340	~390
50~100		11,400	15,500	21,400	25,500	31,500	14,400	18,500	24,400	28,500	34,500	41,700	47,800	52,600
	~140	12,800	16,900	23,500	27,600	34,300	15,800	19,900	26,500	30,600	37,300	44,700	51,400	56,300
	~180	14,000	18,300	25,500	29,700	37,100	17,000	21,300	28,500	32,700	40,100	47,600	54,800	59,800
	~220	15,400	19,700	27,600	31,900	39,800	18,400	22,700	30,600	34,900	42,800	50,600	58,400	63,500
	~260	16,600	21,000	29,600	34,000	42,500	19,600	24,000	32,600	37,000	45,500	53,400	62,000	67,000
	~300	17,900	22,500	31,700	36,100	45,400	20,900	25,500	34,700	39,100	48,400	56,500	65,400	70,700

※ドラム式：仕上り巾39cm以下の場合、仕上り丈は200cmまでとなります。

スリムシェード		コード式
H	W	
50~100		18~30
		16,300
	~140	18,200
	~180	19,600
	~220	21,500
	~240	22,800

style no.50 バルーンプレーン														
		コード式					ドラム式							
スワッグ数		1S	2S	3S	4S	5S	1S	2S	3S	4S	5S	6S	7S	8S
H	W	36~50	~100	~150	~200	~250	40~50	~100	~150	~200	~250	~300	~350	~400
100~140		20,400	30,300	41,000	51,800	65,900	23,400	33,300	44,000	54,800	68,900	81,500	93,900	106,400
	~180	23,300	34,400	46,400	58,400	74,600	26,300	37,400	49,400	61,400	77,600	91,600	105,600	119,700
	~220	26,200	38,400	51,800	65,100	83,300	29,200	41,400	54,800	68,100	86,300	101,600	117,300	133,000
	~260	28,300	42,400	57,100	71,800	92,000	31,300	45,400	60,100	74,800	95,000	111,700	129,000	142,300
	~300	32,000	46,500	62,500	78,500	100,700	35,000	49,500	65,500	81,500	103,700	121,800	140,700	159,500

※出窓の場合はコーナー1ヶ所につきコード式は3,500円、ドラム式は4,500円プラスになります。

style no.51 バルーンフリル														
		コード式					ドラム式							
スワッグ数		1S	2S	3S	4S	5S	1S	2S	3S	4S	5S	6S	7S	8S
H	W	36~50	~100	~150	~200	~250	40~50	~100	~150	~200	~250	~300	~350	~400
100~140		21,500	32,300	43,900	55,600	70,700	24,500	35,300	46,900	58,600	73,700	87,200	100,600	114,000
	~180	24,300	36,300	49,300	62,300	79,400	27,300	39,300	52,300	65,300	82,400	97,300	112,300	127,300
	~220	27,200	40,400	54,700	69,000	88,000	30,200	43,400	57,700	72,000	91,000	107,400	124,000	140,600
	~260	29,300	44,400	60,000	75,600	96,800	32,300	47,400	63,000	78,600	99,800	117,400	135,600	149,900
	~300	33,000	48,500	65,400	82,300	105,500	36,000	51,500	68,400	85,300	108,500	127,500	147,300	167,100

※出窓の場合はコーナー1ヶ所につきコード式は3,500円、ドラム式は4,500円プラスになります。

TM-54357



巾 ◇ 100cm 価格 ◇ 1,400円/m リポート ◇ タテ 29.4cm ヨコ 24.5cm 取扱い表示 ◇ リ-30 40 40 40 40 40 40
 組成 ◇ ポリエステル100% 寸法変化率 ◇ 水洗い/タテ 0.0% ヨコ 0.2% 防炎性能 ◇ (イ) あて布使用
 ドライ/タテ -0.5% ヨコ -0.7% Made in Japan

H	W	~44 1巾(片開き)	~100 2巾	~150 3巾	~200 4巾	~250 5巾	~300 6巾	~350 7巾	~400 8巾
~100		3,900	7,800	11,700	15,400	19,300	23,200	26,800	30,700
~120		4,700	9,400	13,800	18,500	23,200	27,600	32,300	37,000
~140		5,500	11,000	16,200	21,600	26,800	32,300	37,500	42,900
~160		5,500	11,000	16,200	21,600	26,800	32,300	37,500	42,900
~180		6,300	12,300	18,200	24,500	30,700	37,000	42,900	49,200
~200		7,100	13,800	20,800	27,600	34,600	41,400	48,400	55,200
~220		7,100	13,800	20,800	27,600	34,600	41,400	48,400	55,200
~240		7,800	15,400	23,200	30,700	38,300	46,100	53,600	61,400
~260		8,600	16,900	25,300	33,800	42,200	50,500	59,100	67,400
~280		8,600	16,900	25,300	33,800	42,200	50,500	59,100	67,400
約1.5倍ヒダ		~56	~120	~200	~266	~333	~400	~466	~533
フラット約1倍ヒダ		~80	~160	~260	~360	~460	~560		

H	W	~44 1巾(片開き)	~100 2巾	~150 3巾	~200 4巾	~250 5巾	~300 6巾	~350 7巾	~400 8巾
~100		4,200	8,400	12,600	16,600	20,800	25,000	28,900	33,100
~120		5,100	10,100	14,900	19,900	25,000	29,700	34,800	39,800
~140		5,900	11,800	17,400	23,300	28,900	34,800	40,400	46,200
~160		5,900	11,800	17,400	23,300	28,900	34,800	40,400	46,200
~180		6,800	13,200	19,900	26,400	33,100	39,800	46,200	53,000
~200		7,600	14,900	22,400	29,700	37,300	44,600	52,100	59,400
~220		7,600	14,900	22,400	29,700	37,300	44,600	52,100	59,400
~240		8,400	16,600	25,000	33,100	41,200	49,600	57,700	66,100
~260		9,300	18,200	27,200	36,400	45,400	54,400	63,600	72,600
~280		9,300	18,200	27,200	36,400	45,400	54,400	63,600	72,600
約1.5倍ヒダ		~56	~120	~200	~266	~333	~400	~466	~533

※片開きはW270cmまで

H	W	~44 1巾(片開き)	~100 2巾	~150 3巾	~200 4巾	~250 5巾	~300 6巾	~350 7巾	~400 8巾
~100		4,500	9,000	13,500	17,700	22,200	26,700	30,900	35,400
~120		5,400	10,800	15,900	21,300	26,700	31,800	37,200	42,600
~140		6,300	12,600	18,600	24,900	30,900	37,200	43,200	49,500
~160		6,300	12,600	18,600	24,900	30,900	37,200	43,200	49,500
~180		7,200	14,100	21,300	28,200	35,400	42,600	49,500	56,700
~200		8,100	15,900	24,000	31,800	39,900	47,700	55,800	63,600
~220		8,100	15,900	24,000	31,800	39,900	47,700	55,800	63,600
~240		9,000	17,700	26,700	35,400	44,100	53,100	61,800	70,800
~260		9,900	19,500	29,100	39,000	48,600	58,200	68,100	77,700
~280		9,900	19,500	29,100	39,000	48,600	58,200	68,100	77,700
約1.5倍ヒダ		~56	~120	~200	~266	~333	~400	~466	~533

※片開きはW270cmまで

H	W	~44 1巾(片開き)	~100 2巾	~150 3巾	~200 4巾	~250 5巾	~300 6巾	~350 7巾	~400 8巾
~100		5,100	10,200	15,300	20,100	25,200	30,300	35,100	40,200
~120		6,200	12,300	18,100	24,200	30,300	36,100	42,200	48,300
~140		7,200	14,300	21,100	28,300	35,100	42,200	49,000	56,100
~160		7,200	14,300	21,100	28,300	35,100	42,200	49,000	56,100
~180		8,200	16,000	24,200	32,000	40,200	48,300	56,100	64,300
~200		9,200	18,100	27,200	36,100	45,300	54,100	63,300	72,100
~220		9,200	18,100	27,200	36,100	45,300	54,100	63,300	72,100
~240		10,200	20,100	30,300	40,200	50,000	60,200	70,100	80,300
~260		11,300	22,100	33,000	44,200	55,100	66,000	77,200	88,100

※片開きはW300cmまで

		コード式					ドラム式							
H	W	30~45	~90	~140	~190	~240	30~45	~90	~140	~190	~240	~290	~340	~390
50~100		11,500	15,600	21,600	25,700	31,800	14,500	18,600	24,600	28,700	34,800	42,000	48,100	52,900
~140		13,100	17,300	24,200	28,400	35,300	16,100	20,300	27,200	31,400	38,300	45,700	52,800	57,700
~180		14,300	18,600	26,100	30,300	37,800	17,300	21,600	29,100	33,300	40,800	48,300	55,900	60,900
~220		15,900	20,200	28,600	32,800	41,400	18,900	23,200	31,600	35,800	44,400	52,200	60,400	65,500
~260		17,100	21,500	30,400	34,800	43,800	20,100	24,500	33,400	37,800	46,800	54,700	63,700	68,700
~300		18,300	22,900	32,300	36,700	46,300	21,300	25,900	35,300	39,700	49,300	57,400	66,700	72,100

※ドラム式: 仕上り巾39cm以下の場合、仕上り丈は200cmまでとなります。

		コード式
H	W	18~30
50~100		16,400
~140		18,600
~180		19,900
~220		22,100
~240		23,100

		コード式					ドラム式							
H	W	30~45	~90	~140	~190	~240	30~45	~90	~140	~190	~240	~290	~340	~390
50~100		14,200	20,500	28,600	35,200	43,100	17,200	23,500	31,600	38,200	46,100	54,300	62,300	68,800
~140		16,100	22,700	32,100	39,200	48,300	19,100	25,700	35,100	42,200	51,300	59,800	69,000	75,900
~180		17,500	24,600	34,800	42,400	52,400	20,500	27,600	37,800	45,400	55,400	64,300	74,500	81,800
~220		19,300	26,800	38,100	46,100	57,700	22,300	29,800	41,100	49,100	60,700	69,900	80,900	88,500
~260		20,800	28,900	41,200	49,900	62,500	23,800	31,900	44,200	52,900	65,500	75,300	87,100	95,200
~300		22,400	31,100	44,300	53,600	67,200	25,400	34,100	47,300	56,600	70,200	80,400	93,200	101,900

※ドラム式: 仕上り巾39cm以下の場合、仕上り丈は200cmまでとなります。

		スプリング・チェーンタイプ		
H	W	30~60	~80	~90
50~80		27,200	29,700	31,700
~120		29,000	32,100	34,100
~160		30,400	34,200	36,200
~200		33,300	36,300	38,500
~240			38,200	40,500

※丈は巾の3倍までが限度です。
 ※ロールソフト加工品は非防炎品になります。

TM-54358



巾 ◇ 100cm 価格 ◇ 1,400円/m
 組成 ◇ ポリエステル100%

リポート ◇ タテ cm ヨコ 0.5 cm
 寸法変化率 ◇ 水洗い/タテ 0.2% ヨコ -0.5%
 ドライ/タテ -0.5% ヨコ -1.0%

取扱い表示 ◇ リ-30
 防炎性能 ◇ (イ)
 Made in Japan

H	W	~44 1巾(片開き)	~100 2巾	~150 3巾	~200 4巾	~250 5巾	~300 6巾	~350 7巾	~400 8巾
~100		3,700	7,300	11,000	14,600	18,200	21,900	25,500	29,200
~120		4,200	8,400	12,500	16,700	20,800	25,000	29,200	33,300
~140		4,700	9,400	14,100	18,800	23,400	28,100	32,800	37,500
~160		5,200	10,400	15,600	20,800	26,000	31,200	36,400	41,600
~180		5,800	11,500	17,200	22,900	28,600	34,400	40,100	45,800
~200		6,300	12,500	18,800	25,000	31,200	37,500	43,700	50,000
~220		6,800	13,600	20,300	27,100	33,800	40,600	47,400	54,100
~240		7,300	14,600	21,900	29,200	36,400	43,700	51,000	58,300
~260		7,800	15,600	23,400	31,200	39,000	46,800	54,600	62,400
~280		8,400	16,700	25,000	33,300	41,600	50,000	58,300	66,600
約1.5倍ヒダ		~56	~120	~200	~266	~333	~400	~466	~533
フラット縫製		~80	~160	~260	~360	~460	~560		

H	W	~44 1巾(片開き)	~100 2巾	~150 3巾	~200 4巾	~250 5巾	~300 6巾	~350 7巾	~400 8巾
~100		4,000	7,900	11,800	15,700	19,600	23,600	27,500	31,400
~120		4,500	9,000	13,500	18,000	22,400	26,900	31,400	35,900
~140		5,100	10,100	15,200	20,200	25,200	30,300	35,300	40,400
~160		5,600	11,200	16,800	22,400	28,000	33,600	39,200	44,800
~180		6,200	12,400	18,500	24,700	30,800	37,000	43,200	49,300
~200		6,800	13,500	20,200	26,900	33,600	40,400	47,100	53,800
~220		7,300	14,600	21,900	29,200	36,400	43,700	51,000	58,300
~240		7,900	15,700	23,600	31,400	39,200	47,100	54,900	62,800
~260		8,400	16,800	25,200	33,600	42,000	50,400	58,800	67,200
~280		9,000	18,000	26,900	35,900	44,800	53,800	62,800	71,700
約1.5倍ヒダ		~56	~120	~200	~266	~333	~400	~466	~533

※片開きはW270cmまで

H	W	~44 1巾(片開き)	~100 2巾	~150 3巾	~200 4巾	~250 5巾	~300 6巾	~350 7巾	~400 8巾
~100		4,200	8,400	12,600	16,800	21,000	25,200	29,400	33,600
~120		4,800	9,600	14,400	19,200	24,000	28,800	33,600	38,400
~140		5,400	10,800	16,200	21,600	27,000	32,400	37,800	43,200
~160		6,000	12,000	18,000	24,000	30,000	36,000	42,000	48,000
~180		6,600	13,200	19,800	26,400	33,000	39,600	46,200	52,800
~200		7,200	14,400	21,600	28,800	36,000	43,200	50,400	57,600
~220		7,800	15,600	23,400	31,200	39,000	46,800	54,600	62,400
~240		8,400	16,800	25,200	33,600	42,000	50,400	58,800	67,200
~260		9,000	18,000	27,000	36,000	45,000	54,000	63,000	72,000
~280		9,600	19,200	28,800	38,400	48,000	57,600	67,200	76,800
約1.5倍ヒダ		~56	~120	~200	~266	~333	~400	~466	~533

※片開きはW270cmまで

H	W	~44 1巾(片開き)	~100 2巾	~150 3巾	~200 4巾	~250 5巾	~300 6巾	~350 7巾	~400 8巾
~100		4,800	9,600	14,300	19,100	23,800	28,600	33,400	38,100
~120		5,500	10,900	16,400	21,800	27,200	32,700	38,100	43,600
~140		6,200	12,300	18,400	24,500	30,600	36,800	42,900	49,000
~160		6,800	13,600	20,400	27,200	34,000	40,800	47,600	54,400
~180		7,500	15,000	22,500	30,000	37,400	44,900	52,400	59,900
~200		8,200	16,400	24,500	32,700	40,800	49,000	57,200	65,300
~220		8,900	17,700	26,600	35,400	44,200	53,100	61,900	70,800
~240		9,600	19,100	28,600	38,100	47,600	57,200	66,700	76,200
~260		10,200	20,400	30,600	40,800	51,000	61,200	71,400	81,600

※片開きはW300cmまで

		コード式					ドラム式							
		1S	2S	3S	4S	5S	1S	2S	3S	4S	5S	6S	7S	8S
スワッグ数	36~50	~100	~150	~200	~250	40~50	~100	~150	~200	~250	~300	~350	~400	
H	100-140	20,700	30,700	41,500	52,400	66,800	23,700	33,700	44,500	55,400	69,800	82,500	95,100	107,700
	~180	23,600	34,800	47,000	59,200	75,700	26,600	37,800	50,000	62,200	78,700	92,900	107,100	121,300
	~220	26,600	39,000	52,500	66,100	84,600	29,600	42,000	55,500	69,100	87,600	103,200	119,000	134,900
	~260	28,700	43,100	58,000	72,900	93,600	31,700	46,100	61,000	75,900	96,600	113,500	131,000	144,500
	~300	32,500	47,300	63,500	79,700	102,500	35,500	50,300	66,500	82,700	105,500	123,800	143,000	162,100

※出窓の場合はコーナー1ヶ所につきコード式は3,500円、ドラム式は4,500円プラスになります。

TM-54359

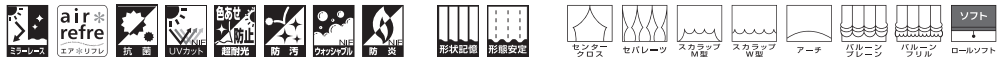

巾 ◇ 100cm 価格 ◇ 1,400円/m
組成 ◇ ポリエステル100%

リポート ◇ タテ cm ヨコ cm
寸法変化率 ◇ 水洗い/タテ 0.0% ヨコ -0.5%
ドライ/タテ 0.0% ヨコ 0.0%

取扱い表示 ◇ リ-30
防炎性能 ◇ (イ)
Made in Japan

H \ W	~44 1巾(片開き)	~100 2巾	~150 3巾	~200 4巾	~250 5巾	~300 6巾	~350 7巾	~400 8巾
~100	3,700	7,300	11,000	14,600	18,200	21,900	25,500	29,200
~120	4,200	8,400	12,500	16,700	20,800	25,000	29,200	33,300
~140	4,700	9,400	14,100	18,800	23,400	28,100	32,800	37,500
~160	5,200	10,400	15,600	20,800	26,000	31,200	36,400	41,600
~180	5,800	11,500	17,200	22,900	28,600	34,400	40,100	45,800
~200	6,300	12,500	18,800	25,000	31,200	37,500	43,700	50,000
~220	6,800	13,600	20,300	27,100	33,800	40,600	47,400	54,100
~240	7,300	14,600	21,900	29,200	36,400	43,700	51,000	58,300
~260	7,800	15,600	23,400	31,200	39,000	46,800	54,600	62,400
~280	8,400	16,700	25,000	33,300	41,600	50,000	58,300	66,600
約1.5倍ヒダ	~56	~120	~200	~266	~333	~400	~466	~533
フラット約1倍ヒダ	~80	~160	~260	~360	~460	~560		

H \ W	~44 1巾(片開き)	~100 2巾	~150 3巾	~200 4巾	~250 5巾	~300 6巾	~350 7巾	~400 8巾
~100	4,000	7,900	11,800	15,700	19,600	23,600	27,500	31,400
~120	4,500	9,000	13,500	18,000	22,400	26,900	31,400	35,900
~140	5,100	10,100	15,200	20,200	25,200	30,300	35,300	40,400
~160	5,600	11,200	16,800	22,400	28,000	33,600	39,200	44,800
~180	6,200	12,400	18,500	24,700	30,800	37,000	43,200	49,300
~200	6,800	13,500	20,200	26,900	33,600	40,400	47,100	53,800
~220	7,300	14,600	21,900	29,200	36,400	43,700	51,000	58,300
~240	7,900	15,700	23,600	31,400	39,200	47,100	54,900	62,800
~260	8,400	16,800	25,200	33,600	42,000	50,400	58,800	67,200
~280	9,000	18,000	26,900	35,900	44,800	53,800	62,800	71,700
約1.5倍ヒダ	~56	~120	~200	~266	~333	~400	~466	~533

H \ W	~44 1巾(片開き)	~100 2巾	~150 3巾	~200 4巾	~250 5巾	~300 6巾	~350 7巾	~400 8巾
~100	4,200	8,400	12,600	16,800	21,000	25,200	29,400	33,600
~120	4,800	9,600	14,400	19,200	24,000	28,800	33,600	38,400
~140	5,400	10,800	16,200	21,600	27,000	32,400	37,800	43,200
~160	6,000	12,000	18,000	24,000	30,000	36,000	42,000	48,000
~180	6,600	13,200	19,800	26,400	33,000	39,600	46,200	52,800
~200	7,200	14,400	21,600	28,800	36,000	43,200	50,400	57,600
~220	7,800	15,600	23,400	31,200	39,000	46,800	54,600	62,400
~240	8,400	16,800	25,200	33,600	42,000	50,400	58,800	67,200
~260	9,000	18,000	27,000	36,000	45,000	54,000	63,000	72,000
~280	9,600	19,200	28,800	38,400	48,000	57,600	67,200	76,800
約1.5倍ヒダ	~56	~120	~200	~266	~333	~400	~466	~533

H \ W	~44 1巾(片開き)	~100 2巾	~150 3巾	~200 4巾	~250 5巾	~300 6巾	~350 7巾	~400 8巾
~100	4,800	9,600	14,300	19,100	23,800	28,600	33,400	38,100
~120	5,500	10,900	16,400	21,800	27,200	32,700	38,100	43,600
~140	6,200	12,300	18,400	24,500	30,600	36,800	42,900	49,000
~160	6,800	13,600	20,400	27,200	34,000	40,800	47,600	54,400
~180	7,500	15,000	22,500	30,000	37,400	44,900	52,400	59,900
~200	8,200	16,400	24,500	32,700	40,800	49,000	57,200	65,300
~220	8,900	17,700	26,600	35,400	44,200	53,100	61,900	70,800
~240	9,600	19,100	28,600	38,100	47,600	57,200	66,700	76,200
~260	10,200	20,400	30,600	40,800	51,000	61,200	71,400	81,600

センタークロス

H \ W	~80	~120	~160	~200	~240	~280	~320
~100	9,600	12,500					
~120	10,600	14,200	19,100				
~140	11,700	15,900	21,400	26,600			
~160	12,500	17,500	23,800	29,400	34,200		
~180	13,800	19,300	26,000	32,300	37,500	45,400	
~200	15,100	21,000	28,200	34,500	41,700	49,400	56,700
~220	16,200	22,600	30,600	37,400	44,000	53,200	60,200
~240	17,500	24,400	32,800	40,100	47,200	57,200	64,700
~260	18,800	27,400	35,100	42,800	50,400	61,200	67,700

セバレーツ

H \ W	~40(1P)	~50(1P)	~60(1P)
~100	11,000	13,800	15,000
~120	12,400	15,500	16,700
~140	13,800	17,100	18,400
~160	15,100	18,700	19,900
~180	16,500	20,400	21,600
~200	18,100	22,100	23,300
~220	19,100	23,600	24,800
~240	20,500	25,000	26,100
~260	22,000	26,500	27,400

レースフレンジ style no.12 (タッセル含む)

H \ W	~80	~120	~160	~200	~240	~280	~320
~100	12,800	16,800					
~120	14,100	18,700	24,900				
~140	15,300	20,700	27,500	33,800			
~160	16,500	22,600	30,100	36,900	42,700		
~180	17,900	24,600	32,600	39,900	46,200	55,700	
~200	19,400	26,500	35,000	42,500	50,800	59,800	68,400
~220	20,800	28,400	37,600	45,500	53,200	64,000	72,200
~240	22,300	30,300	40,100	48,500	56,700	68,200	76,900
~260	23,800	33,500	42,600	51,500	60,200	72,400	80,200

スカラップM型

ウェーブ数	3W	4W	5W	6W	7W	
H \ W	100-130	~160	~190	~240	~290	~330
80-100	16,000	19,300	23,500	28,700	37,900	43,400
~120	17,600	21,600	26,300	31,900	42,200	47,700
~140	19,200	23,500	28,700	34,900	46,100	52,800
~160	20,700	25,000	30,700	37,500	49,500	57,400
~180	22,300	26,900	33,100	40,400	53,400	62,500
~200		35,400	43,400	57,300	67,500	

スカラップW型

ウェーブ数	2W	3W	4W	5W	6W	7W	
H \ W	60-100	~130	~160	~190	~240	~290	~330
80-100	12,600	16,000	19,300	23,500	28,700	37,900	43,400
~120	13,800	17,600	21,600	26,300	31,900	42,200	47,700
~140	15,100	19,200	23,500	28,700	34,900	46,100	52,800
~160	16,500	20,700	25,000	30,700	37,500	49,500	57,400
~180	18,100	22,300	26,900	33,100	40,400	53,400	62,500
~200		35,400	43,400	57,300	67,500		

アーチ

H \ W	60-100	~130	~160	~190	~240	~290	~330
80-100	12,300	15,600	18,900	22,900	28,000	37,000	42,300
~120	13,500	17,100	21,200	25,700	31,300	41,300	46,700
~140	14,700	18,700	23,100	28,100	34,200	45,100	51,700
~160	16,000	20,300	24,600	30,100	36,800	48,600	56,400
~180	17,300	22,000	26,500	32,500	39,800	52,500	61,400
~200		34,900	42,700	56,400	66,500		

レースフレンジ style no.18

ウェーブ数	3W	4W	5W	6W	7W	
H \ W	100-130	~160	~190	~240	~290	~330
80-100	18,400	21,800	26,600	32,400	43,100	49,200
~120	19,900	24,100	29,400	35,600	47,400	53,600
~140	21,500	26,000	31,700	38,600	51,300	58,600
~160	23,100	27,500	33,800	41,200	54,700	63,200
~180	24,700	29,400	36,100	44,100	58,600	68,300
~200		38,500	47,100	62,500	73,300	

レースフレンジ style no.20

ウェーブ数	2W	3W	4W	5W	6W	7W	
H \ W	60-100	~130	~160	~190	~240	~290	~330
80-100	14,300	18,400	21,800	26,600	32,400	43,100	49,200
~120	15,600	19,900	24,100	29,400	35,600	47,400	53,600
~140	16,800	21,500	26,000	31,700	38,600	51,300	58,600
~160	18,100	23,100	27,500	33,800	41,200	54,700	63,200
~180	19,400	24,700	29,400	36,100	44,100	58,600	68,300
~200		38,500	47,100	62,500	73,300		

レースフレンジ style no.27

H \ W	60-100	~130	~160	~190	~240	~290	~330
80-100	13,700	17,500	20,900	25,500	31,100	41,300	47,200
~120	15,000	19,100	23,200	28,300	34,300	45,600	51,500
~140	16,200	20,700	25,100	30,700	37,300	49,400	56,600
~160	17,400	22,200	26,600	32,700	39,900	52,900	61,200
~180	18,600	23,700	28,100	34,200	42,800	56,800	66,200
~200		37,400	45,800	60,700	71,300		

style no.50 バルーンプレーン													
	コード式					ドラム式							
スワッグ数	1S	2S	3S	4S	5S	1S	2S	3S	4S	5S	6S	7S	8S
H	36~50	~100	~150	~200	~250	40~50	~100	~150	~200	~250	~300	~350	~400
100~140	20,700	30,700	41,500	52,400	66,800	23,700	33,700	44,500	55,400	69,800	82,500	95,100	107,700
~180	23,600	34,800	47,000	59,200	75,700	26,600	37,800	50,000	62,200	78,700	92,900	107,100	121,300
~220	26,600	39,000	52,500	66,100	84,600	29,600	42,000	55,500	69,100	87,600	103,200	119,000	134,900
~260	28,700	43,100	58,000	72,900	93,600	31,700	46,100	61,000	75,900	96,600	113,500	131,000	144,500
~300	32,500	47,300	63,500	79,700	102,500	35,500	50,300	66,500	82,700	105,500	123,800	143,000	162,100

※出窓の場合はコーナー1ヶ所につきコード式は3,500円、ドラム式は4,500円プラスになります。

style no.51 バルーンフリル													
	コード式					ドラム式							
スワッグ数	1S	2S	3S	4S	5S	1S	2S	3S	4S	5S	6S	7S	8S
H	36~50	~100	~150	~200	~250	40~50	~100	~150	~200	~250	~300	~350	~400
100~140	21,800	32,800	44,700	56,500	71,900	24,800	35,800	47,700	59,500	74,900	88,700	102,300	115,900
~180	24,700	37,000	50,200	63,400	80,800	27,700	40,000	53,200	66,400	83,800	99,000	114,200	129,500
~220	27,700	41,100	55,700	70,200	89,800	30,700	44,100	58,700	73,200	92,800	109,300	126,200	143,100
~260	29,900	45,200	61,100	77,000	98,700	32,900	48,200	64,100	80,000	101,700	119,700	138,200	152,700
~300	33,600	49,400	66,700	83,900	107,600	36,600	52,400	69,700	86,900	110,600	130,000	150,100	170,200

※出窓の場合はコーナー1ヶ所につきコード式は3,500円、ドラム式は4,500円プラスになります。

style no.S01 ロールソフト			
スプリング・チェーンタイプ			
スワッグ数	30~60	~80	~90
H	30~60	~80	~90
50~80	27,200	29,700	31,700
~120	28,700	31,800	33,800
~160	30,300	34,100	36,100
~200	32,900	35,900	38,100
~240		38,000	40,300

※丈は巾の3倍までが限度です。

※ロールソフト加工品は非防炎品になります。

TM-54360

涼しゃ

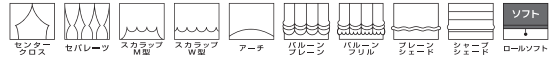

巾 ◇ 100cm 価格 ◇ 1,200円/m
組成 ◇ ポリエステル100%

リポート ◇ タテ 26.0cm ヨコ 24.7cm
寸法変化率 ◇ 水洗い/タテ -0.2% ヨコ 1.5%
ドライ/タテ -0.2% ヨコ -1.5%

取扱い表示 ◇ リ-30
防炎性能 ◇ (イ)
Made in Japan

H \ W	~44 1巾(片開き)	~100 2巾	~150 3巾	~200 4巾	~250 5巾	~300 6巾	~350 7巾	~400 8巾
~100	3,900	7,700	11,300	15,200	18,800	22,600	26,400	30,000
~120	4,600	8,900	13,200	17,600	21,900	26,400	30,800	35,100
~140	4,600	8,900	13,200	17,600	21,900	26,400	30,800	35,100
~160	5,100	10,100	15,200	20,200	25,000	30,000	35,100	40,100
~180	5,800	11,300	17,100	22,600	28,100	33,900	39,400	45,200
~200	6,300	12,500	18,800	25,000	31,200	37,500	43,700	50,000
~220	6,300	12,500	18,800	25,000	31,200	37,500	43,700	50,000
~240	7,000	14,000	20,700	27,600	34,400	41,300	48,300	55,000
~260	7,700	15,200	22,600	30,000	37,500	45,200	52,600	60,000
~280	8,200	16,400	24,500	32,700	40,600	48,800	56,900	65,100
約1.5倍ヒダ	~56	~120	~200	~266	~333	~400	~466	~533
フラット前ヒダ	~80	~160	~260	~360	~460	~560		

H \ W	~44 1巾(片開き)	~100 2巾	~150 3巾	~200 4巾	~250 5巾	~300 6巾	~350 7巾	~400 8巾
~100	4,200	8,400	12,300	16,400	20,300	24,500	28,600	32,500
~120	5,000	9,700	14,300	19,000	23,700	28,600	33,300	38,000
~140	5,000	9,700	14,300	19,000	23,700	28,600	33,300	38,000
~160	5,500	11,000	16,400	21,900	27,100	32,500	38,000	43,500
~180	6,300	12,300	18,500	24,500	30,500	36,700	42,700	48,900
~200	6,800	13,600	20,300	27,100	33,800	40,600	47,400	54,100
~220	6,800	13,600	20,300	27,100	33,800	40,600	47,400	54,100
~240	7,600	15,100	22,400	29,900	37,200	44,800	52,300	59,600
~260	8,400	16,400	24,500	32,500	40,600	48,900	57,000	65,000
~280	8,900	17,700	26,600	35,400	44,000	52,800	61,700	70,500
約1.5倍ヒダ	~56	~120	~200	~266	~333	~400	~466	~533

H \ W	~44 1巾(片開き)	~100 2巾	~150 3巾	~200 4巾	~250 5巾	~300 6巾	~350 7巾	~400 8巾
~100	4,500	9,000	13,200	17,700	21,900	26,400	30,800	35,000
~120	5,400	10,400	15,400	20,500	25,500	30,800	35,900	40,900
~140	5,400	10,400	15,400	20,500	25,500	30,800	35,900	40,900
~160	5,900	11,800	17,700	23,600	29,200	35,000	40,900	46,800
~180	6,800	13,200	19,900	26,400	32,800	39,500	46,000	52,700
~200	7,300	14,600	21,900	29,200	36,400	43,700	51,000	58,300
~220	7,300	14,600	21,900	29,200	36,400	43,700	51,000	58,300
~240	8,200	16,300	24,100	32,200	40,100	48,200	56,300	64,200
~260	9,000	17,700	26,400	35,000	43,700	52,700	61,400	70,000
~280	9,600	19,100	28,600	38,100	47,400	56,900	66,400	75,900
約1.5倍ヒダ	~56	~120	~200	~266	~333	~400	~466	~533

H \ W	~44 1巾(片開き)	~100 2巾	~150 3巾	~200 4巾	~250 5巾	~300 6巾	~350 7巾	~400 8巾
~100	5,200	10,300	15,100	20,200	25,000	30,100	35,200	40,000
~120	6,100	11,900	17,600	23,400	29,200	35,200	41,000	46,800
~140	6,100	11,900	17,600	23,400	29,200	35,200	41,000	46,800
~160	6,800	13,500	20,200	26,900	33,300	40,000	46,800	53,500
~180	7,700	15,100	22,800	30,100	37,500	45,200	52,500	60,200
~200	8,400	16,700	25,000	33,300	41,600	50,000	58,300	66,600
~220	8,400	16,700	25,000	33,300	41,600	50,000	58,300	66,600
~240	9,300	18,600	27,600	36,800	45,800	55,100	64,400	73,300
~260	10,300	20,200	30,100	40,000	50,000	60,200	70,100	80,000

センタークロス

H \ W	~80	~120	~160	~200	~240	~280	~320
~100	9,400	12,200					
~120	10,000	13,300	17,800				
~140	11,100	15,100	20,300	25,200			
~160	12,000	16,700	22,700	28,100	32,700		
~180	13,200	18,600	25,000	31,000	36,100	43,700	
~200	14,000	19,600	26,300	32,100	39,000	46,000	52,900
~220	15,200	21,300	28,800	35,100	41,300	50,000	56,600
~240	16,500	23,000	31,000	38,000	44,700	54,100	61,200
~260	17,800	26,100	33,400	40,700	48,100	58,300	64,500

セバレーツ

H \ W	~40(1P)	~50(1P)	~60(1P)
~100	10,800	13,600	14,800
~120	11,900	14,800	15,900
~140	13,300	16,400	17,700
~160	14,600	18,000	19,300
~180	16,000	19,700	20,900
~200	17,200	20,800	22,000
~220	18,300	22,400	23,600
~240	19,800	23,900	25,000
~260	21,300	25,400	26,300

レースフレンジ style no.12 (タッセル含む)

H \ W	~80	~120	~160	~200	~240	~280	~320
~100	12,800	16,800					
~120	13,700	18,100	24,100				
~140	15,000	20,200	26,800	32,900			
~160	16,200	22,100	29,400	36,000	41,800		
~180	17,700	24,200	32,100	39,200	45,400	54,700	
~200	18,700	25,500	33,600	40,600	48,600	57,200	65,400
~220	20,200	27,500	36,300	43,800	51,200	61,600	69,500
~240	21,700	29,400	38,900	47,000	54,800	66,000	74,300
~260	23,300	32,700	41,500	50,100	58,500	70,400	77,800

スカラップM型

ウェーブ数	3W	4W	5W	6W	7W	
H \ W	100-130	~160	~190	~240	~290	~330
80-100	15,600	18,900	22,900	28,000	37,000	42,300
~120	16,300	20,300	24,600	29,900	39,400	44,600
~140	18,000	22,300	27,100	33,100	43,500	49,900
~160	19,700	23,900	29,200	35,900	47,200	54,800
~180		26,000	31,800	38,900	51,300	60,100
~200			33,000	40,500	53,300	63,000

スカラップW型

ウェーブ数	2W	3W	4W	5W	6W	7W	
H \ W	60-100	~130	~160	~190	~240	~290	~330
80-100	12,300	15,600	18,900	22,900	28,000	37,000	42,300
~120	12,900	16,300	20,300	24,600	29,900	39,400	44,600
~140	14,200	18,000	22,300	27,100	33,100	43,500	49,900
~160		19,700	23,900	29,200	35,900	47,200	54,800
~180			26,000	31,800	38,900	51,300	60,100
~200				33,000	40,500	53,300	63,000

アーチ

H \ W	60-100	~130	~160	~190	~240	~290	~330
80-100	12,000	15,200	18,500	22,500	27,400	36,200	41,400
~120	12,600	15,900	19,900	24,100	29,300	38,600	43,700
~140	13,900	17,700	21,900	26,600	32,500	42,700	49,000
~160		19,300	23,500	28,800	35,300	46,400	53,800
~180			25,600	31,300	38,300	50,500	59,200
~200				32,500	39,900	52,500	62,100

レースフレンジ style no.18

ウェーブ数	3W	4W	5W	6W	7W	
H \ W	100-130	~160	~190	~240	~290	~330
80-100	18,400	21,800	26,700	32,500	43,300	49,400
~120	19,100	23,200	28,300	34,400	45,600	51,600
~140	20,900	25,300	30,800	37,500	49,800	56,900
~160	22,500	26,900	33,000	40,300	53,400	61,800
~180		28,900	35,500	43,400	57,600	67,100
~200			36,700	45,000	59,600	70,100

レースフレンジ style no.20

ウェーブ数	2W	3W	4W	5W	6W	7W	
H \ W	60-100	~130	~160	~190	~240	~290	~330
80-100	14,400	18,400	21,800	26,700	32,500	43,300	49,400
~120	15,000	19,100	23,200	28,300	34,400	45,600	51,600
~140	16,300	20,900	25,300	30,800	37,500	49,800	56,900
~160		22,500	26,900	33,000	40,300	53,400	61,800
~180			28,900	35,500	43,400	57,600	67,100
~200				36,700	45,000	59,600	70,100

レースフレンジ style no.27

H \ W	60-100	~130	~160	~190	~240	~290	~330
80-100	13,800	17,600	21,000	25,600	31,200	41,400	47,300
~120	14,400	18,300	22,400	27,200	33,100	43,800	49,600
~140	15,700	20,000	24,400	29,700	36,200	47,900	54,900
~160		21,700	26,000	31,900	39,000	51,600	59,700
~180			28,100	34,400	42,100	55,800	65,100
~200				35,700	43,700	57,800	68,000

style no.60 プレーンシェード														
コード式					ドラム式									
H	W	30~45	~90	~140	~190	~240	30~45	~90	~140	~190	~240	~290	~340	~390
50~100		11,400	15,500	21,400	25,500	31,500	14,400	18,500	24,400	28,500	34,500	41,700	47,800	52,600
	~140	12,900	17,100	23,700	27,900	34,600	15,900	20,100	26,700	30,900	37,600	45,000	51,800	56,700
	~180	14,000	18,200	25,400	29,600	36,900	17,000	21,200	28,400	32,600	39,900	47,300	54,500	59,500
	~220	15,400	19,700	27,600	31,900	39,800	18,400	22,700	30,600	34,900	42,800	50,600	58,400	63,500
	~260	16,500	20,900	29,300	33,700	42,000	19,500	23,900	32,300	36,700	45,000	52,900	61,400	66,400
	~300	17,900	22,400	31,500	35,900	45,200	20,900	25,400	34,500	38,900	48,200	56,300	65,100	70,500

※ドラム式：仕上り巾39cm以下の場合、仕上り丈は200cmまでとなります。

スリムシェード	
コード式	
H	W
50~100	18~30
	16,300
	~140
	18,400
	~180
	19,600
	~220
	21,500
	~240
	22,500

style no.63 シャープシェード														
コード式					ドラム式									
H	W	30~45	~90	~140	~190	~240	30~45	~90	~140	~190	~240	~290	~340	~390
50~100		14,100	20,400	28,400	35,000	42,800	17,100	23,400	31,400	38,000	45,800	54,000	62,000	68,500
	~140	15,800	22,500	31,600	38,600	47,500	18,800	25,500	34,600	41,600	50,500	59,100	67,900	74,800
	~180	17,100	24,200	34,000	41,600	51,400	20,100	27,200	37,000	44,600	54,400	63,300	73,100	80,400
	~220	18,700	26,200	37,100	45,100	56,000	21,700	29,200	40,100	48,100	59,000	68,300	78,700	86,400
	~260	20,100	28,300	40,100	48,700	60,600	23,100	31,300	43,100	51,700	63,600	73,300	84,600	92,800
	~300	21,900	30,600	43,500	52,700	66,000	24,900	33,600	46,500	55,700	69,000	79,200	91,500	100,200

※ドラム式：仕上り巾39cm以下の場合、仕上り丈は200cmまでとなります。

style no.50 バルーンブレン														
コード式					ドラム式									
スワッグ数		1S	2S	3S	4S	5S	1S	2S	3S	4S	5S	6S	7S	8S
H	W	36~50	~100	~150	~200	~250	40~50	~100	~150	~200	~250	~300	~350	~400
100~140		20,700	30,600	41,400	52,200	66,500	23,700	33,600	44,400	55,200	69,500	82,200	94,700	107,200
	~180	23,200	34,200	46,100	58,000	74,000	26,200	37,200	49,100	61,000	77,000	91,000	105,000	118,900
	~220	26,200	38,400	51,800	65,100	83,300	29,200	41,400	54,800	68,100	86,300	101,600	117,300	133,000
	~260	28,000	42,000	56,500	70,900	90,900	31,000	45,000	59,500	73,900	93,900	110,400	127,500	140,600
	~300	31,800	46,300	62,200	78,000	100,100	34,800	49,300	65,200	81,000	103,100	121,200	140,000	158,700

※出窓の場合はコーナー1ヶ所につきコード式は3,500円、ドラム式は4,500円プラスになります。

style no.51 バルーンフリル														
コード式					ドラム式									
スワッグ数		1S	2S	3S	4S	5S	1S	2S	3S	4S	5S	6S	7S	8S
H	W	36~50	~100	~150	~200	~250	40~50	~100	~150	~200	~250	~300	~350	~400
100~140		21,600	32,400	44,100	55,700	70,900	24,600	35,400	47,100	58,700	73,900	87,500	100,900	114,200
	~180	24,100	36,000	48,800	61,600	78,400	27,100	39,000	51,800	64,600	81,400	96,300	111,100	125,900
	~220	27,100	40,200	54,500	68,700	87,700	30,100	43,200	57,500	71,700	90,700	106,900	123,400	140,000
	~260	29,000	43,800	59,200	74,500	95,300	32,000	46,800	62,200	77,500	98,300	115,700	133,700	147,600
	~300	32,800	48,100	64,900	81,600	104,500	35,800	51,100	67,900	84,600	107,500	126,500	146,100	165,700

※出窓の場合はコーナー1ヶ所につきコード式は3,500円、ドラム式は4,500円プラスになります。

style no.S01 ロールソフト		
スプリング・チェーンタイプ		
H	W	
		30~60
		~80
		~90
50~80		27,100
		29,600
		31,600
	~120	28,800
		31,900
		33,900
	~160	30,100
		33,900
		35,900
	~200	32,700
		35,700
		37,900
	~240	37,600
		39,900

※丈は巾の3倍までが限度です。

※ロールソフト加工品は非防炎品になります。

style no.50 バルーンプレーン													
	コード式					ドラム式							
スワッグ数	1S	2S	3S	4S	5S	1S	2S	3S	4S	5S	6S	7S	8S
H	36~50	~100	~150	~200	~250	40~50	~100	~150	~200	~250	~300	~350	~400
100~140	20,700	30,700	41,500	52,400	66,800	23,700	33,700	44,500	55,400	69,800	82,500	95,100	107,700
~180	23,600	34,800	47,000	59,200	75,700	26,600	37,800	50,000	62,200	78,700	92,900	107,100	121,300
~220	26,600	39,000	52,500	66,100	84,600	29,600	42,000	55,500	69,100	87,600	103,200	119,000	134,900
~260	28,700	43,100	58,000	72,900	93,600	31,700	46,100	61,000	75,900	96,600	113,500	131,000	144,500
~300	32,500	47,300	63,500	79,700	102,500	35,500	50,300	66,500	82,700	105,500	123,800	143,000	162,100

※ 出窓の場合はコーナー1ヶ所につきコード式は3,500円、ドラム式は4,500円プラスになります。

style no.51 バルーンフリル													
	コード式					ドラム式							
スワッグ数	1S	2S	3S	4S	5S	1S	2S	3S	4S	5S	6S	7S	8S
H	36~50	~100	~150	~200	~250	40~50	~100	~150	~200	~250	~300	~350	~400
100~140	21,800	32,800	44,700	56,500	71,900	24,800	35,800	47,700	59,500	74,900	88,700	102,300	115,900
~180	24,700	37,000	50,200	63,400	80,800	27,700	40,000	53,200	66,400	83,800	99,000	114,200	129,500
~220	27,700	41,100	55,700	70,200	89,800	30,700	44,100	58,700	73,200	92,800	109,300	126,200	143,100
~260	29,900	45,200	61,100	77,000	98,700	32,900	48,200	64,100	80,000	101,700	119,700	138,200	152,700
~300	33,600	49,400	66,700	83,900	107,600	36,600	52,400	69,700	86,900	110,600	130,000	150,100	170,200

※ 出窓の場合はコーナー1ヶ所につきコード式は3,500円、ドラム式は4,500円プラスになります。

TM-54362



巾 ◇ 100cm 価格 ◇ 1,350円/m リポート ◇ タテ cm ヨコ 1.1 cm 取扱い表示 ◇ リ-30 40 炎 1 2 3 4 5 6 7 8 9 10 11 12 13 14 15 16 17 18 19 20 21 22 23 24 25 26 27 28 29 30 31 32 33 34 35 36 37 38 39 40 41 42 43 44 45 46 47 48 49 50 51 52 53 54 55 56 57 58 59 60 61 62 63 64 65 66 67 68 69 70 71 72 73 74 75 76 77 78 79 80 81 82 83 84 85 86 87 88 89 90 91 92 93 94 95 96 97 98 99 100
 組成 ◇ ポリエステル100% 寸法変化率 ◇ 水洗い/タテ 0.0% ヨコ 0.0% 防炎性能 ◇ (イ) 乾燥/タテ 0.0% ヨコ 0.0% Made in Japan

H	W	~44 1巾(片開き)	~100 2巾	~150 3巾	~200 4巾	~250 5巾	~300 6巾	~350 7巾	~400 8巾
~100		3,600	7,200	10,800	14,300	17,900	21,500	25,000	28,600
~120		4,100	8,200	12,300	16,400	20,400	24,500	28,600	32,700
~140		4,600	9,200	13,800	18,400	23,000	27,600	32,200	36,800
~160		5,100	10,200	15,300	20,400	25,500	30,600	35,700	40,800
~180		5,700	11,300	16,900	22,500	28,100	33,700	39,300	44,900
~200		6,200	12,300	18,400	24,500	30,600	36,800	42,900	49,000
~220		6,700	13,300	19,900	26,600	33,200	39,800	46,500	53,100
~240		7,200	14,300	21,500	28,600	35,700	42,900	50,000	57,200
~260		7,700	15,300	23,000	30,600	38,300	45,900	53,600	61,200
~280		8,200	16,400	24,500	32,700	40,800	49,000	57,200	65,300
約1.5倍ヒダ		~56	~120	~200	~266	~333	~400	~466	~533
フラット前ヒダ		~80	~160	~260	~360	~460	~560		

H	W	~44 1巾(片開き)	~100 2巾	~150 3巾	~200 4巾	~250 5巾	~300 6巾	~350 7巾	~400 8巾
~100		3,900	7,700	11,600	15,400	19,300	23,100	27,000	30,800
~120		4,400	8,800	13,200	17,600	22,000	26,400	30,800	35,200
~140		5,000	9,900	14,900	19,800	24,800	29,700	34,700	39,600
~160		5,500	11,000	16,500	22,000	27,500	33,000	38,500	44,000
~180		6,100	12,100	18,200	24,200	30,300	36,300	42,400	48,400
~200		6,600	13,200	19,800	26,400	33,000	39,600	46,200	52,800
~220		7,200	14,300	21,500	28,600	35,800	42,900	50,100	57,200
~240		7,700	15,400	23,100	30,800	38,500	46,200	53,900	61,600
~260		8,300	16,500	24,800	33,000	41,300	49,500	57,800	66,000
~280		8,800	17,600	26,400	35,200	44,000	52,800	61,600	70,400
約1.5倍ヒダ		~56	~120	~200	~266	~333	~400	~466	~533

H	W	~44 1巾(片開き)	~100 2巾	~150 3巾	~200 4巾	~250 5巾	~300 6巾	~350 7巾	~400 8巾
~100		4,200	8,300	12,400	16,600	20,700	24,800	29,000	33,100
~120		4,800	9,500	14,200	18,900	23,600	28,400	33,100	37,800
~140		5,400	10,700	16,000	21,300	26,600	31,900	37,200	42,500
~160		5,900	11,800	17,700	23,600	29,500	35,400	41,300	47,200
~180		6,500	13,000	19,500	26,000	32,500	39,000	45,500	52,000
~200		7,100	14,200	21,300	28,400	35,400	42,500	49,600	56,700
~220		7,700	15,400	23,100	30,700	38,400	46,100	53,700	61,400
~240		8,300	16,600	24,800	33,100	41,300	49,600	57,900	66,100
~260		8,900	17,700	26,600	35,400	44,300	53,100	62,000	70,800
~280		9,500	18,900	28,400	37,800	47,200	56,700	66,100	75,600
約1.5倍ヒダ		~56	~120	~200	~266	~333	~400	~466	~533

H	W	~44 1巾(片開き)	~100 2巾	~150 3巾	~200 4巾	~250 5巾	~300 6巾	~350 7巾	~400 8巾
~100		4,700	9,400	14,100	18,800	23,500	28,200	32,900	37,600
~120		5,400	10,800	16,100	21,500	26,800	32,200	37,600	42,900
~140		6,100	12,100	18,100	24,200	30,200	36,200	42,300	48,300
~160		6,700	13,400	20,100	26,800	33,500	40,200	46,900	53,600
~180		7,400	14,800	22,200	29,500	36,900	44,300	51,600	59,000
~200		8,100	16,100	24,200	32,200	40,200	48,300	56,300	64,400
~220		8,800	17,500	26,200	34,900	43,600	52,300	61,000	69,700
~240		9,400	18,800	28,200	37,600	46,900	56,300	65,700	75,100
~260		10,100	20,100	30,200	40,200	50,300	60,300	70,400	80,400

センタークロス

H	W	~80	~120	~160	~200	~240	~280	~320
~100		9,400	12,300					
~120		10,500	14,000	18,800				
~140		11,500	15,700	21,100	26,200			
~160		12,300	17,300	23,400	29,000	33,600		
~180		13,600	19,000	25,600	31,700	36,900	44,700	
~200		14,800	20,700	27,800	33,900	41,100	48,600	55,800
~220		15,900	22,200	30,100	36,700	43,200	52,300	59,200
~240		17,200	24,000	32,300	39,500	46,400	56,300	63,600
~260		18,400	27,000	34,500	42,100	49,600	60,200	66,600

セバレーツ

H	W	~40(1P)	~50(1P)	~60(1P)
~100		10,900	13,600	14,800
~120		12,300	15,300	16,500
~140		13,600	16,900	18,100
~160		15,000	18,400	19,700
~180		16,300	20,100	21,400
~200		17,900	21,800	23,000
~220		18,900	23,300	24,500
~240		20,300	24,700	25,700
~260		21,800	26,200	27,000

レースフレンジ style no.12 (タッセル含む)

H	W	~80	~120	~160	~200	~240	~280	~320
~100		12,700	16,700					
~120		14,000	18,600	24,700				
~140		15,200	20,500	27,200	33,500			
~160		16,300	22,400	29,800	36,500	42,300		
~180		17,800	24,300	32,300	39,500	45,700	55,100	
~200		19,200	26,200	34,700	42,000	50,300	59,200	67,700
~220		20,700	28,100	37,200	45,100	52,600	63,300	71,400
~240		22,100	30,000	39,700	48,000	56,000	67,500	76,100
~260		23,600	33,200	42,200	51,000	59,500	71,600	79,300

スカラップM型

ウェーブ数	3W	4W	5W	6W	7W	
H	100-130	~160	~190	~240	~290	~330
80-100	15,700	19,000	23,100	28,200	37,300	42,700
~120	17,200	21,300	25,900	31,400	41,500	47,000
~140	18,800	23,100	28,200	34,300	45,300	51,900
~160	20,300	24,600	30,200	36,900	48,700	56,500
~180		26,500	32,500	39,800	52,500	61,400
~200			34,900	42,700	56,400	66,400

スカラップW型

ウェーブ数	2W	3W	4W	5W	6W	7W	
H	60-100	~130	~160	~190	~240	~290	~330
80-100	12,400	15,700	19,000	23,100	28,200	37,300	42,700
~120	13,600	17,200	21,300	25,900	31,400	41,500	47,000
~140	14,800	18,800	23,100	28,200	34,300	45,300	51,900
~160		20,300	24,600	30,200	36,900	48,700	56,500
~180			26,500	32,500	39,800	52,500	61,400
~200				34,900	42,700	56,400	66,400

アーチ

H	W	60-100	~130	~160	~190	~240	~290	~330	
80-100		12,100	15,300	18,600	22,600	27,600	36,400	41,700	
~120		13,300	16,800	20,800	25,300	30,800	40,600	45,900	
~140		14,500	18,400	22,700	27,700	33,700	44,400	50,900	
~160			19,900	24,200	29,600	36,200	47,800	55,500	
~180				26,100	32,000	39,100	51,600	60,400	
~200						34,300	42,000	55,400	65,400

レースフレンジ style no.18

ウェーブ数	3W	4W	5W	6W	7W	
H	100-130	~160	~190	~240	~290	~330
80-100	18,200	21,600	26,400	32,100	42,700	48,800
~120	19,700	23,900	29,100	35,300	46,900	53,100
~140	21,300	25,700	31,400	38,200	50,800	58,000
~160	22,800	27,200	33,400	40,800	54,100	62,600
~180		29,100	35,800	43,700	58,000	67,600
~200			38,100	46,600	61,800	72,500

レースフレンジ style no.20

ウェーブ数	2W	3W	4W	5W	6W	7W	
H	60-100	~130	~160	~190	~240	~290	~330
80-100	14,200	18,200	21,600	26,400	32,100	42,700	48,800
~120	15,400	19,700	23,900	29,100	35,300	46,900	53,100
~140	16,700	21,300	25,700	31,400	38,200	50,800	58,000
~160		22,800	27,200	33,400	40,800	54,100	62,600
~180			29,100	35,800	43,700	58,000	67,600
~200				38,100	46,600	61,800	72,500

レースフレンジ style no.27

H	W	60-100	~130	~160	~190	~240	~290	~330
80-100		13,600	17,400	20,700	25,300	30,800	40,900	46,800
~120		14,800	18,900	23,000	28,000	34,000	45,100	51

style no.60 プレーンシェード														
コード式					ドラム式									
H	W	30~45	~90	~140	~190	~240	30~45	~90	~140	~190	~240	~290	~340	~390
50	~100	11,500	15,600	21,500	25,600	31,700	14,500	18,600	24,500	28,600	34,700	41,800	48,000	52,800
	~140	12,800	17,000	23,600	27,800	34,500	15,800	20,000	26,600	30,800	37,500	44,900	51,700	56,600
	~180	14,100	18,400	25,700	29,900	37,300	17,100	21,400	28,700	32,900	40,300	47,800	55,100	60,200
	~220	15,500	19,800	27,800	32,100	40,100	18,500	22,800	30,800	35,100	43,100	50,900	58,800	63,900
	~260	16,700	21,200	29,800	34,200	42,900	19,700	24,200	32,800	37,200	45,900	53,800	62,500	67,500
	~300	18,100	22,600	31,900	36,300	45,800	21,100	25,600	34,900	39,300	48,800	56,900	65,900	71,300

※ドラム式：仕上り巾39cm以下の場合、仕上り丈は200cmまでとなります。

スリムシェード	
コード式	
H	W
50	~100
	~140
	~180
	~220
	~240

style no.63 シャープシェード														
コード式					ドラム式									
H	W	30~45	~90	~140	~190	~240	30~45	~90	~140	~190	~240	~290	~340	~390
50	~100	14,200	20,500	28,500	35,100	43,000	17,200	23,500	31,500	38,100	46,000	54,100	62,200	68,700
	~140	15,700	22,400	31,500	38,500	47,400	18,700	25,400	34,500	41,500	50,400	59,000	67,800	74,700
	~180	17,200	24,400	34,300	41,900	51,900	20,200	27,400	37,300	44,900	54,900	63,800	73,800	81,000
	~220	18,800	26,300	37,300	45,300	56,300	21,800	29,300	40,300	48,300	59,300	68,600	79,200	86,800
	~260	20,400	28,600	40,600	49,200	61,500	23,400	31,600	43,600	52,200	64,500	74,200	85,800	93,900
	~300	22,100	30,800	43,900	53,200	66,600	25,100	33,800	46,900	56,200	69,600	79,900	92,400	101,100

※ドラム式：仕上り巾39cm以下の場合、仕上り丈は200cmまでとなります。

style no.50 バルーンブレン														
コード式					ドラム式									
スワッグ数		1S	2S	3S	4S	5S	1S	2S	3S	4S	5S	6S	7S	8S
H	W	36~50	~100	~150	~200	~250	40~50	~100	~150	~200	~250	~300	~350	~400
100	~140	20,600	30,500	41,300	52,100	66,300	23,600	33,500	44,300	55,100	69,300	82,000	94,500	107,000
	~180	23,500	34,600	46,700	58,800	75,100	26,500	37,600	49,700	61,800	78,100	92,200	106,300	120,500
	~220	26,400	38,700	52,100	65,600	83,900	29,400	41,700	55,100	68,600	86,900	102,400	118,200	133,900
	~260	28,500	42,800	57,600	72,300	92,800	31,500	45,800	60,600	75,300	95,800	112,600	130,000	143,400
	~300	32,200	46,900	63,000	79,100	101,600	35,200	49,900	66,000	82,100	104,600	122,800	141,800	160,800

※出窓の場合はコーナー1ヶ所につきコード式は3,500円、ドラム式は4,500円プラスになります。

style no.51 バルーンフリル														
コード式					ドラム式									
スワッグ数		1S	2S	3S	4S	5S	1S	2S	3S	4S	5S	6S	7S	8S
H	W	36~50	~100	~150	~200	~250	40~50	~100	~150	~200	~250	~300	~350	~400
100	~140	21,600	32,500	44,300	56,100	71,300	24,600	35,500	47,300	59,100	74,300	87,900	101,400	114,900
	~180	24,500	36,600	49,700	62,800	80,100	27,500	39,600	52,700	65,800	83,100	98,200	113,300	128,400
	~220	27,500	40,700	55,200	69,600	88,900	30,500	43,700	58,200	72,600	91,900	108,300	125,100	141,800
	~260	29,600	44,800	60,600	76,300	97,700	32,600	47,800	63,600	79,300	100,700	118,600	136,900	151,300
	~300	33,300	48,900	66,000	83,100	106,500	36,300	51,900	69,000	86,100	109,500	128,700	148,700	168,700

※出窓の場合はコーナー1ヶ所につきコード式は3,500円、ドラム式は4,500円プラスになります。

style no.S01 ロールソフト		
スプリング・チェーンタイプ		
H	W	
50	~80	30~60
	~120	~80
	~160	~90
	~200	
	~240	

※丈は巾の3倍までが限度です。
 ※ロールソフト加工品は非防炎品になります。

TM-54363



巾 ◇ 100cm 価格 ◇ 1,800円/m
組成 ◇ ポリエステル100%

リポート ◇ タテ cm ヨコ cm
寸法変化率 ◇ 水洗い/タテ -1.0% ヨコ -1.0%
ドライ/タテ -1.0% ヨコ -1.0%

取扱い表示 ◇ リ-30 40 50 60 70 80 90 100
防炎性能 ◇ (イ) あて布使用
Made in Japan

H \ W	~44 1巾(片開き)	~100 2巾	~150 3巾	~200 4巾	~250 5巾	~300 6巾	~350 7巾	~400 8巾
~100	4,200	8,400	12,600	16,800	21,000	25,200	29,400	33,600
~120	4,800	9,600	14,400	19,200	24,000	28,800	33,600	38,400
~140	5,400	10,800	16,200	21,600	27,000	32,400	37,800	43,200
~160	6,000	12,000	18,000	24,000	30,000	36,000	42,000	48,000
~180	6,600	13,200	19,800	26,400	33,000	39,600	46,200	52,800
~200	7,200	14,400	21,600	28,800	36,000	43,200	50,400	57,600
~220	7,800	15,600	23,400	31,200	39,000	46,800	54,600	62,400
~240	8,400	16,800	25,200	33,600	42,000	50,400	58,800	67,200
~260	9,000	18,000	27,000	36,000	45,000	54,000	63,000	72,000
~280	9,600	19,200	28,800	38,400	48,000	57,600	67,200	76,800
約1.5倍ヒダ	~56	~120	~200	~266	~333	~400	~466	~533
フラット約1倍ヒダ	~80	~160	~260	~360	~460	~560		

H \ W	~44 1巾(片開き)	~100 2巾	~150 3巾	~200 4巾	~250 5巾	~300 6巾	~350 7巾	~400 8巾
~100	4,500	9,000	13,500	18,000	22,400	26,900	31,400	35,900
~120	5,200	10,300	15,400	20,500	25,600	30,800	35,900	41,000
~140	5,800	11,600	17,300	23,100	28,800	34,600	40,400	46,100
~160	6,400	12,800	19,200	25,600	32,000	38,400	44,800	51,200
~180	7,100	14,100	21,200	28,200	35,200	42,300	49,300	56,400
~200	7,700	15,400	23,100	30,800	38,400	46,100	53,800	61,500
~220	8,400	16,700	25,000	33,300	41,600	50,000	58,300	66,600
~240	9,000	18,000	26,900	35,900	44,800	53,800	62,800	71,700
~260	9,600	19,200	28,800	38,400	48,000	57,600	67,200	76,800
~280	10,300	20,500	30,800	41,000	51,200	61,500	71,700	82,000
約1.5倍ヒダ	~56	~120	~200	~266	~333	~400	~466	~533

※片開きはW270cmまで

H \ W	~44 1巾(片開き)	~100 2巾	~150 3巾	~200 4巾	~250 5巾	~300 6巾	~350 7巾	~400 8巾
~100	4,800	9,600	14,300	19,100	23,800	28,600	33,400	38,100
~120	5,500	10,900	16,400	21,800	27,200	32,700	38,100	43,600
~140	6,200	12,300	18,400	24,500	30,600	36,800	42,900	49,000
~160	6,800	13,600	20,400	27,200	34,000	40,800	47,600	54,400
~180	7,500	15,000	22,500	30,000	37,400	44,900	52,400	59,900
~200	8,200	16,400	24,500	32,700	40,800	49,000	57,200	65,300
~220	8,900	17,700	26,600	35,400	44,200	53,100	61,900	70,800
~240	9,600	19,100	28,600	38,100	47,600	57,200	66,700	76,200
~260	10,200	20,400	30,600	40,800	51,000	61,200	71,400	81,600
~280	10,900	21,800	32,700	43,600	54,400	65,300	76,200	87,100
約1.5倍ヒダ	~56	~120	~200	~266	~333	~400	~466	~533

※片開きはW270cmまで

H \ W	~44 1巾(片開き)	~100 2巾	~150 3巾	~200 4巾	~250 5巾	~300 6巾	~350 7巾	~400 8巾
~100	5,400	10,700	16,000	21,300	26,600	32,000	37,300	42,600
~120	6,100	12,200	18,300	24,400	30,400	36,500	42,600	48,700
~140	6,900	13,700	20,600	27,400	34,200	41,100	47,900	54,800
~160	7,600	15,200	22,800	30,400	38,000	45,600	53,200	60,800
~180	8,400	16,800	25,100	33,500	41,800	50,200	58,600	66,900
~200	9,200	18,300	27,400	36,500	45,600	54,800	63,900	73,000
~220	9,900	19,800	29,700	39,600	49,400	59,300	69,200	79,100
~240	10,700	21,300	32,000	42,600	53,200	63,900	74,500	85,200
~260	11,400	22,800	34,200	45,600	57,000	68,400	79,800	91,200

※片開きはW300cmまで

		コード式				ドラム式								
H \ W		30~45	~90	~140	~190	~240	30~45	~90	~140	~190	~240	~290	~340	~390
50~100		12,000	16,000	22,500	26,500	33,000	15,000	19,000	25,500	29,500	36,000	43,200	49,900	54,700
~140		13,500	17,600	24,800	29,000	36,300	16,500	20,600	27,800	32,000	39,300	46,800	54,200	59,100
~180		14,900	19,100	27,200	31,400	39,600	17,900	22,100	30,200	34,400	42,600	50,100	58,200	63,300
~220		16,400	20,700	29,600	33,900	42,800	19,400	23,700	32,600	36,900	45,800	53,700	62,500	67,600
~260		17,900	22,300	32,000	36,300	46,100	20,900	25,300	35,000	39,300	49,100	57,000	66,800	71,800
~300		19,400	23,800	34,400	38,800	49,400	22,400	26,800	37,400	41,800	52,400	60,600	70,900	76,200

※ドラム式: 仕上り巾39cm以下の場合、仕上り巾は200cmまでとなります。

		コード式
H \ W		18~30
50~100		16,800
~140		18,900
~180		20,400
~220		22,500
~240		23,800

		コード式				ドラム式								
H \ W		30~45	~90	~140	~190	~240	30~45	~90	~140	~190	~240	~290	~340	~390
50~100		14,700	20,900	29,500	36,100	44,400	17,700	23,900	32,500	39,100	47,400	55,600	64,100	70,700
~140		16,400	23,100	32,800	39,800	49,400	19,400	26,100	35,800	42,800	52,400	60,900	70,400	77,300
~180		18,000	25,200	36,000	43,500	54,300	21,000	28,200	39,000	46,500	57,300	66,200	77,000	84,300
~220		19,800	27,300	39,200	47,200	59,300	22,800	30,300	42,200	50,200	62,300	71,500	83,100	90,700
~260		21,500	29,700	42,900	51,500	64,900	24,500	32,700	45,900	54,500	67,900	77,600	90,300	98,500
~300		23,400	32,100	46,500	55,700	70,500	26,400	35,100	49,500	58,700	73,500	83,800	97,600	106,200

※ドラム式: 仕上り巾39cm以下の場合、仕上り巾は200cmまでとなります。

		スプリング・チェーンタイプ	
H \ W		30~60	~80
50~80		27,600	30,100
~120		29,300	32,400
~160		30,900	34,700
~200		33,700	38,900
~240			38,900

※丈は巾の3倍までが限度です。
※ロールソフト加工品は非防炎品となります。

TM-54364



巾 ◇ 100cm 価格 ◇ 1,600円/m
 組成 ◇ ポリエステル100%

リポート ◇ タテ cm ヨコ 1.5cm
 寸法変化率 ◇ 水洗い/タテ -0.2% ヨコ -0.3%
 ドライ/タテ -0.3% ヨコ -1.0%

取扱い表示 ◇ リ-30
 防炎性能 ◇ (イ) あて布使用
 Made in Japan

H	W	~44 1巾(片開き)	~100 2巾	~150 3巾	~200 4巾	~250 5巾	~300 6巾	~350 7巾	~400 8巾
~100		4,000	7,900	11,800	15,700	19,600	23,600	27,500	31,400
~120		4,500	9,000	13,500	18,000	22,400	26,900	31,400	35,900
~140		5,100	10,100	15,200	20,200	25,200	30,300	35,300	40,400
~160		5,600	11,200	16,800	22,400	28,000	33,600	39,200	44,800
~180		6,200	12,400	18,500	24,700	30,800	37,000	43,200	49,300
~200		6,800	13,500	20,200	26,900	33,600	40,400	47,100	53,800
~220		7,300	14,600	21,900	29,200	36,400	43,700	51,000	58,300
~240		7,900	15,700	23,600	31,400	39,200	47,100	54,900	62,800
~260		8,400	16,800	25,200	33,600	42,000	50,400	58,800	67,200
~280		9,000	18,000	26,900	35,900	44,800	53,800	62,800	71,700
約1.5倍ヒダ		~56	~120	~200	~266	~333	~400	~466	~533
フラット縫製		~80	~160	~260	~360	~460	~560		

H	W	~44 1巾(片開き)	~100 2巾	~150 3巾	~200 4巾	~250 5巾	~300 6巾	~350 7巾	~400 8巾
~100		4,200	8,400	12,600	16,800	21,000	25,200	29,400	33,600
~120		4,800	9,600	14,400	19,200	24,000	28,800	33,600	38,400
~140		5,400	10,800	16,200	21,600	27,000	32,400	37,800	43,200
~160		6,000	12,000	18,000	24,000	30,000	36,000	42,000	48,000
~180		6,600	13,200	19,800	26,400	33,000	39,600	46,200	52,800
~200		7,200	14,400	21,600	28,800	36,000	43,200	50,400	57,600
~220		7,800	15,600	23,400	31,200	39,000	46,800	54,600	62,400
~240		8,400	16,800	25,200	33,600	42,000	50,400	58,800	67,200
~260		9,000	18,000	27,000	36,000	45,000	54,000	63,000	72,000
~280		9,600	19,200	28,800	38,400	48,000	57,600	67,200	76,800
約1.5倍ヒダ		~56	~120	~200	~266	~333	~400	~466	~533

※片開きはW270cmまで

H	W	~44 1巾(片開き)	~100 2巾	~150 3巾	~200 4巾	~250 5巾	~300 6巾	~350 7巾	~400 8巾
~100		4,500	9,000	13,500	18,000	22,400	26,900	31,400	35,900
~120		5,200	10,300	15,400	20,500	25,600	30,800	35,900	41,000
~140		5,800	11,600	17,300	23,100	28,800	34,600	40,400	46,100
~160		6,400	12,800	19,200	25,600	32,000	38,400	44,800	51,200
~180		7,100	14,100	21,200	28,200	35,200	42,300	49,300	56,400
~200		7,700	15,400	23,100	30,800	38,400	46,100	53,800	61,500
~220		8,400	16,700	25,000	33,300	41,600	50,000	58,300	66,600
~240		9,000	18,000	26,900	35,900	44,800	53,800	62,800	71,700
~260		9,600	19,200	28,800	38,400	48,000	57,600	67,200	76,800
~280		10,300	20,500	30,800	41,000	51,200	61,500	71,700	82,000
約1.5倍ヒダ		~56	~120	~200	~266	~333	~400	~466	~533

※片開きはW270cmまで

H	W	~44 1巾(片開き)	~100 2巾	~150 3巾	~200 4巾	~250 5巾	~300 6巾	~350 7巾	~400 8巾
~100		5,100	10,100	15,200	20,200	25,200	30,300	35,300	40,400
~120		5,800	11,600	17,300	23,100	28,800	34,600	40,400	46,100
~140		6,500	13,000	19,500	26,000	32,400	38,900	45,400	51,900
~160		7,200	14,400	21,600	28,800	36,000	43,200	50,400	57,600
~180		8,000	15,900	23,800	31,700	39,600	47,600	55,500	63,400
~200		8,700	17,300	26,000	34,600	43,200	51,900	60,500	69,200
~220		9,400	18,800	28,100	37,500	46,800	56,200	65,600	74,900
~240		10,100	20,200	30,300	40,400	50,400	60,500	70,600	80,700
~260		10,800	21,600	32,400	43,200	54,000	64,800	75,600	86,400

※片開きはW300cmまで

コード式					ドラム式									
H	W	30~45	~90	~140	~190	~240	30~45	~90	~140	~190	~240	~290	~340	~390
50~100		11,700	15,800	22,000	26,100	32,400	14,700	18,800	25,000	29,100	35,400	42,600	49,000	53,800
~140		13,200	17,300	24,300	28,400	35,500	16,200	20,300	27,300	31,400	38,500	46,000	53,100	58,000
~180		14,600	18,800	26,500	30,800	38,600	17,600	21,800	29,500	33,800	41,600	49,100	56,900	61,900
~220		16,000	20,300	28,800	33,100	41,600	19,000	23,300	31,800	36,100	44,600	52,400	60,900	66,000
~260		17,400	21,800	31,000	35,400	44,700	20,400	24,800	34,000	38,400	47,700	55,600	64,900	69,900
~300		18,800	23,300	33,300	37,700	47,800	21,800	26,300	36,300	40,700	50,800	58,900	68,700	74,000

※ドラム式: 仕上り巾39cm以下の場合、仕上り丈は200cmまでとなります。

コード式	
H	W
50~100	18~30
~140	16,600
~180	18,600
~220	20,100
~240	22,100
~240	23,400

コード式					ドラム式									
H	W	30~45	~90	~140	~190	~240	30~45	~90	~140	~190	~240	~290	~340	~390
50~100		14,400	20,700	29,100	35,700	43,800	17,400	23,700	32,100	38,700	46,800	55,000	63,300	69,800
~140		16,100	22,800	32,200	39,200	48,500	19,100	25,800	35,200	42,200	51,500	60,100	69,300	76,100
~180		17,700	24,800	35,200	42,800	53,200	20,700	27,800	38,200	45,800	56,200	65,100	75,600	82,800
~220		19,300	26,900	38,400	46,400	58,000	22,300	29,900	41,400	49,400	61,000	70,200	81,300	89,000
~260		21,000	29,200	41,900	50,500	63,400	24,000	32,200	44,900	53,500	66,400	76,100	88,300	96,500
~300		22,800	31,500	45,400	54,600	68,800	25,800	34,500	48,400	57,600	71,800	82,000	95,300	103,900

※ドラム式: 仕上り巾39cm以下の場合、仕上り丈は200cmまでとなります。

スプリング・チェーンタイプ		
H	W	~90
50~80		27,400
~120		29,900
~160		31,900
~200		34,100
~240		36,400
~240		38,500
~240		40,700

※丈は巾の3倍までが限度です。
 ※ロールソフト加工品は非防炎品になります。

TM-54365



巾 ◇ 100cm 価 格 ◇ 1,300円/m リポート ◇ タテ cm ヨコ 1.8cm 取扱表示 ◇ リ-30 40 50 60 70 80 90 100 110 120 130 140 150 160 170 180 190 200 210 220 230 240 250 260 270 280 290 300 310 320 330 340 350 360 370 380 390 400 410 420 430 440 450 460 470 480 490 500 510 520 530 540 550 560 570 580 590 600 610 620 630 640 650 660 670 680 690 700 710 720 730 740 750 760 770 780 790 800 810 820 830 840 850 860 870 880 890 900 910 920 930 940 950 960 970 980 990 1000
 組 成 ◇ ポリエステル100% 寸法変化率 ◇ 水洗い/タテ -0.2% ヨコ 0.0% 防炎性能 ◇ (イ) 乾燥/タテ 0.0% ヨコ -0.5% Made in Japan

H	W	~44 1巾(片開き)	~100 2巾	~150 3巾	~200 4巾	~250 5巾	~300 6巾	~350 7巾	~400 8巾
~100		3,500	7,000	10,500	14,000	17,500	21,000	24,500	28,000
~120		4,000	8,000	12,000	16,000	20,000	24,000	28,000	32,000
~140		4,500	9,000	13,500	18,000	22,500	27,000	31,500	36,000
~160		5,000	10,000	15,000	20,000	25,000	30,000	35,000	40,000
~180		5,500	11,000	16,500	22,000	27,500	33,000	38,500	44,000
~200		6,000	12,000	18,000	24,000	30,000	36,000	42,000	48,000
~220		6,500	13,000	19,500	26,000	32,500	39,000	45,500	52,000
~240		7,000	14,000	21,000	28,000	35,000	42,000	49,000	56,000
~260		7,500	15,000	22,500	30,000	37,500	45,000	52,500	60,000
~280		8,000	16,000	24,000	32,000	40,000	48,000	56,000	64,000
約1.5倍ヒダ		~56	~120	~200	~266	~333	~400	~466	~533
フラット約1倍ヒダ		~80	~160	~260	~360	~460	~560		

H	W	~44 1巾(片開き)	~100 2巾	~150 3巾	~200 4巾	~250 5巾	~300 6巾	~350 7巾	~400 8巾
~100		3,800	7,600	11,400	15,200	18,900	22,700	26,500	30,300
~120		4,400	8,700	13,000	17,300	21,600	26,000	30,300	34,600
~140		4,900	9,800	14,600	19,500	24,300	29,200	34,100	38,900
~160		5,400	10,800	16,200	21,600	27,000	32,400	37,800	43,200
~180		6,000	11,900	17,900	23,800	29,700	35,700	41,600	47,600
~200		6,500	13,000	19,500	26,000	32,400	38,900	45,400	51,900
~220		7,100	14,100	21,100	28,100	35,100	42,200	49,200	56,200
~240		7,600	15,200	22,700	30,300	37,800	45,400	53,000	60,500
~260		8,100	16,200	24,300	32,400	40,500	48,600	56,700	64,800
~280		8,700	17,300	26,000	34,600	43,200	51,900	60,500	69,200
約1.5倍ヒダ		~56	~120	~200	~266	~333	~400	~466	~533

※片開きはW270cmまで

H	W	~44 1巾(片開き)	~100 2巾	~150 3巾	~200 4巾	~250 5巾	~300 6巾	~350 7巾	~400 8巾
~100		4,100	8,200	12,200	16,300	20,300	24,400	28,500	32,500
~120		4,700	9,300	14,000	18,600	23,200	27,900	32,500	37,200
~140		5,300	10,500	15,700	20,900	26,100	31,400	36,600	41,800
~160		5,800	11,600	17,400	23,200	29,000	34,800	40,600	46,400
~180		6,400	12,800	19,200	25,600	31,900	38,300	44,700	51,100
~200		7,000	14,000	20,900	27,900	34,800	41,800	48,800	55,700
~220		7,600	15,100	22,700	30,200	37,700	45,300	52,800	60,400
~240		8,200	16,300	24,400	32,500	40,600	48,800	56,900	65,000
~260		8,700	17,400	26,100	34,800	43,500	52,200	60,900	69,600
~280		9,300	18,600	27,900	37,200	46,400	55,700	65,000	74,300
約1.5倍ヒダ		~56	~120	~200	~266	~333	~400	~466	~533

※片開きはW270cmまで

H	W	~44 1巾(片開き)	~100 2巾	~150 3巾	~200 4巾	~250 5巾	~300 6巾	~350 7巾	~400 8巾
~100		4,700	9,300	13,900	18,500	23,100	27,800	32,400	37,000
~120		5,300	10,600	15,900	21,200	26,400	31,700	37,000	42,300
~140		6,000	11,900	17,900	23,800	29,700	35,700	41,600	47,600
~160		6,600	13,200	19,800	26,400	33,000	39,600	46,200	52,800
~180		7,300	14,600	21,800	29,100	36,300	43,600	50,900	58,100
~200		8,000	15,900	23,800	31,700	39,600	47,600	55,500	63,400
~220		8,600	17,200	25,800	34,400	42,900	51,500	60,100	68,700
~240		9,300	18,500	27,800	37,000	46,200	55,500	64,700	74,000
~260		9,900	19,800	29,700	39,600	49,500	59,400	69,300	79,200

※片開きはW300cmまで

		コード式					ドラム式							
H	W	30~45	~90	~140	~190	~240	30~45	~90	~140	~190	~240	~290	~340	~390
50~100		11,400	15,500	21,400	25,500	31,500	14,400	18,500	24,400	28,500	34,500	41,700	47,800	52,600
~140		12,800	16,900	23,500	27,600	34,300	15,800	19,900	26,500	30,600	37,300	44,700	51,400	56,300
~180		14,000	18,300	25,500	29,700	37,100	17,000	21,300	28,500	32,700	40,100	47,600	54,800	59,800
~220		15,400	19,700	27,600	31,900	39,800	18,400	22,700	30,600	34,900	42,800	50,600	58,400	63,500
~260		16,600	21,000	29,600	34,000	42,500	19,600	24,000	32,600	37,000	45,500	53,400	62,000	67,000
~300		17,900	22,500	31,700	36,100	45,400	20,900	25,500	34,700	39,100	48,400	56,500	65,400	70,700

※ドラム式: 仕上り巾39cm以下の場合、仕上り丈は200cmまでとなります。

		コード式
H	W	18~30
50~100		16,300
~140		18,200
~180		19,600
~220		21,500
~240		22,800

		コード式					ドラム式							
H	W	30~45	~90	~140	~190	~240	30~45	~90	~140	~190	~240	~290	~340	~390
50~100		14,100	20,400	28,400	35,000	42,800	17,100	23,400	31,400	38,000	45,800	54,000	62,000	68,500
~140		15,700	22,300	31,300	38,400	47,200	18,700	25,300	34,300	41,400	50,200	58,800	67,600	74,400
~180		17,100	24,300	34,200	41,700	51,600	20,100	27,300	37,200	44,700	54,600	63,500	73,400	80,700
~220		18,700	26,200	37,100	45,100	56,000	21,700	29,200	40,100	48,100	59,000	68,300	78,700	86,400
~260		20,300	28,400	40,300	49,000	61,100	23,300	31,400	43,300	52,000	64,100	73,900	85,300	93,400
~300		22,000	30,600	43,600	52,900	66,200	25,000	33,600	46,600	55,900	69,200	79,400	91,800	100,500

※ドラム式: 仕上り巾39cm以下の場合、仕上り丈は200cmまでとなります。

		スプリング・チェーンタイプ		
H	W	30~60	~80	~90
50~80		27,100	29,600	31,600
~120		28,600	31,700	33,700
~160		30,100	33,900	35,900
~200		32,700	35,700	37,900
~240			37,800	40,100

※丈は巾の3倍までが限度です。
 ※ロールソフト加工品は非防炎品になります。

TM-54366



巾 ◇ 100cm 価格 ◇ 1,500円/m
 組成 ◇ タテ: ポリエステル100%
 ヨコ: ポリエステル96.8% アクリル1.9%
 ナイロン1.3%

リピート ◇ タテ cm ヨコ 9.7 cm
 寸法変化率 ◇ 水洗い/タテ 0.5% ヨコ 0.0%
 ドライ/タテ -0.8% ヨコ -0.2%

取扱い表示 ◇ リ-30
 防炎性能 ◇ (イ)
 Made in Japan

H	W	~44 1巾(片開き)	~100 2巾	~150 3巾	~200 4巾	~250 5巾	~300 6巾	~350 7巾	~400 8巾
~100		3,800	7,600	11,400	15,200	18,900	22,700	26,500	30,300
~120		4,400	8,700	13,000	17,300	21,600	26,000	30,300	34,600
~140		4,900	9,800	14,600	19,500	24,300	29,200	34,100	38,900
~160		5,400	10,800	16,200	21,600	27,000	32,400	37,800	43,200
~180		6,000	11,900	17,900	23,800	29,700	35,700	41,600	47,600
~200		6,500	13,000	19,500	26,000	32,400	38,900	45,400	51,900
~220		7,100	14,100	21,100	28,100	35,100	42,200	49,200	56,200
~240		7,600	15,200	22,700	30,300	37,800	45,400	53,000	60,500
~260		8,100	16,200	24,300	32,400	40,500	48,600	56,700	64,800
~280		8,700	17,300	26,000	34,600	43,200	51,900	60,500	69,200
約1.5倍ヒダ		~56	~120	~200	~266	~333	~400	~466	~533
フラット前ヒダ		~80	~160	~260	~360	~460	~560		

センタークロス

H	W	~80	~120	~160	~200	~240	~280	~320
~100		9,900	12,900					
~120		11,000	14,700	19,700				
~140		12,000	16,500	22,100	27,500			
~160		13,000	18,100	24,600	30,400	35,300		
~180		14,300	20,000	26,900	33,300	38,700	46,900	
~200		15,600	21,700	29,200	35,600	43,100	51,000	58,500
~220		16,800	23,400	31,600	38,600	45,400	55,000	62,200
~240		18,100	25,200	33,900	41,500	48,800	59,100	66,800
~260		19,400	28,300	36,300	44,200	52,100	63,200	70,000

H	W	~80	~120	~160	~200	~240	~280	~320
~100		13,000	17,100					
~120		14,300	19,100	25,400				
~140		15,500	21,000	28,000	34,500			
~160		16,700	23,000	30,600	37,600	43,500		
~180		18,200	25,000	33,200	40,700	47,100	56,800	
~200		19,700	27,000	35,700	43,300	51,800	61,100	69,800
~220		21,200	28,900	38,400	46,500	54,300	65,400	73,800
~240		22,700	30,900	40,900	49,500	57,900	69,700	78,700
~260		24,200	34,200	43,500	52,600	61,500	74,000	82,100

セパレーツ

H	W	~40(1P)	~50(1P)	~60(1P)
~100		11,200	14,100	15,300
~120		12,700	15,900	17,100
~140		14,000	17,500	18,800
~160		15,500	19,100	20,400
~180		16,800	20,900	22,200
~200		18,400	22,700	23,900
~220		19,500	24,200	25,500
~240		20,900	25,700	26,800
~260		22,500	27,300	28,100

スカラップM型

ウェーブ数	3W	4W	5W	6W	7W	
80~100	16,600	19,900	24,300	29,600	39,200	44,800
~120	18,200	22,300	27,100	32,900	43,600	49,300
~140	19,900	24,300	29,600	36,000	47,600	54,500
~160	21,500	25,800	31,700	38,700	51,200	59,300
~180	27,800	34,100	41,700	55,300	64,500	
~200		36,600	44,800	59,300	69,700	

ウェーブ数	3W	4W	5W	6W	7W	
80~100	18,700	22,100	27,000	32,900	43,900	50,100
~120	20,300	24,500	29,900	36,200	48,300	54,600
~140	22,000	26,500	32,300	39,300	52,300	59,700
~160	23,600	28,000	34,400	42,000	55,800	64,500
~180		30,000	36,900	45,000	59,900	69,700
~200		39,400	48,100	63,900	74,900	

スカラップW型

ウェーブ数	2W	3W	4W	5W	6W	7W	
80~100	13,000	16,600	19,900	24,300	29,600	39,200	44,800
~120	14,300	18,200	22,300	27,100	32,900	43,600	49,300
~140	15,600	19,900	24,300	29,600	36,000	47,600	54,500
~160		21,500	25,800	31,700	38,700	51,200	59,300
~180		27,800	34,100	41,700	55,300	64,500	
~200			36,600	44,800	59,300	69,700	

ウェーブ数	2W	3W	4W	5W	6W	7W	
80~100	14,600	18,700	22,100	27,000	32,900	43,900	50,100
~120	15,900	20,300	24,500	29,900	36,200	48,300	54,600
~140	17,200	22,000	26,500	32,300	39,300	52,300	59,700
~160		23,600	28,000	34,400	42,000	55,800	64,500
~180		30,000	36,900	45,000	59,900	69,700	
~200		39,400	48,100	63,900	74,900		

アーチ

H	W	60~100	~130	~160	~190	~240	~290	~330
80~100		12,700	16,100	19,400	23,700	28,900	38,200	43,700
~120		13,900	17,700	21,800	26,500	32,200	42,600	48,200
~140		15,200	19,400	23,800	29,000	35,300	46,600	53,400
~160			21,000	25,300	31,100	38,000	50,200	58,200
~180				27,300	33,500	41,000	54,300	63,400
~200					36,000	44,100	58,300	68,600

H	W	60~100	~130	~160	~190	~240	~290	~330
80~100		14,000	17,900	21,300	25,900	31,600	42,000	48,000
~120		15,200	19,500	23,600	28,800	35,000	46,400	52,500
~140		16,500	21,100	25,600	31,300	38,000	50,500	57,700
~160			22,800	27,200	33,400	40,700	54,000	62,500
~180				29,100	35,800	43,700	58,100	67,700
~200					38,300	46,800	62,100	72,900

レース

 style no.50 バルーンプレーン

スラッグ数 H \ W	コード式					ドラム式							
	1S	2S	3S	4S	5S	1S	2S	3S	4S	5S	6S	7S	8S
36~50	~100	~150	~200	~250		40~50	~100	~150	~200	~250	~300	~350	~400
100-140	20,900	31,100	42,100	53,000	67,700	23,900	34,100	45,100	56,000	70,700	83,500	96,200	109,000
~180	23,900	35,300	47,700	60,000	76,800	26,900	38,300	50,700	63,000	79,800	94,100	108,500	122,900
~220	27,000	39,600	53,300	67,100	85,900	30,000	42,600	56,300	70,100	88,900	104,700	120,800	136,800
~260	29,200	43,800	58,900	74,000	95,100	32,200	46,800	61,900	77,000	98,100	115,300	133,000	146,800
~300	33,000	48,000	64,500	81,000	104,300	36,000	51,000	67,500	84,000	107,300	125,900	145,300	164,600

※ 出窓の場合はコーナー1ヶ所につきコード式は3,500円、ドラム式は4,500円プラスになります。

 style no.51 バルーンフリル

スラッグ数 H \ W	コード式					ドラム式							
	1S	2S	3S	4S	5S	1S	2S	3S	4S	5S	6S	7S	8S
36~50	~100	~150	~200	~250		40~50	~100	~150	~200	~250	~300	~350	~400
100-140	22,100	33,400	45,400	57,500	73,200	25,100	36,400	48,400	60,500	76,200	90,100	103,900	117,700
~180	25,100	37,600	51,000	64,500	82,300	28,100	40,600	54,000	67,500	85,300	100,700	116,200	131,700
~220	28,200	41,800	56,700	71,500	91,500	31,200	44,800	59,700	74,500	94,500	111,300	128,400	145,600
~260	30,400	46,100	62,300	78,500	100,600	33,400	49,100	65,300	81,500	103,600	121,900	140,700	155,500
~300	34,200	50,300	67,900	85,500	109,800	37,200	53,300	70,900	88,500	112,800	132,500	153,000	173,400

※ 出窓の場合はコーナー1ヶ所につきコード式は3,500円、ドラム式は4,500円プラスになります。

 style no.50 バルーンプレーン

スラッグ数 H \ W	コード式					ドラム式							
	1S	2S	3S	4S	5S	1S	2S	3S	4S	5S	6S	7S	8S
36~50	~100	~150	~200	~250		40~50	~100	~150	~200	~250	~300	~350	~400
100-140	20,700	30,700	41,500	52,400	66,800	23,700	33,700	44,500	55,400	69,800	82,500	95,100	107,700
~180	23,600	34,800	47,000	59,200	75,700	26,600	37,800	50,000	62,200	78,700	92,900	107,100	121,300
~220	26,600	39,000	52,500	66,100	84,600	29,600	42,000	55,500	69,100	87,600	103,200	119,000	134,900
~260	28,700	43,100	58,000	72,900	93,600	31,700	46,100	61,000	75,900	96,600	113,500	131,000	144,500
~300	32,500	47,300	63,500	79,700	102,500	35,500	50,300	66,500	82,700	105,500	123,800	143,000	162,100

※ 出窓の場合はコーナー1ヶ所につきコード式は3,500円、ドラム式は4,500円プラスになります。

 style no.51 バルーンフリル

スラッグ数 H \ W	コード式					ドラム式							
	1S	2S	3S	4S	5S	1S	2S	3S	4S	5S	6S	7S	8S
36~50	~100	~150	~200	~250		40~50	~100	~150	~200	~250	~300	~350	~400
100-140	21,800	32,800	44,700	56,500	71,900	24,800	35,800	47,700	59,500	74,900	88,700	102,300	115,900
~180	24,700	37,000	50,200	63,400	80,800	27,700	40,000	53,200	66,400	83,800	99,000	114,200	129,500
~220	27,700	41,100	55,700	70,200	89,800	30,700	44,100	58,700	73,200	92,800	109,300	126,200	143,100
~260	29,900	45,200	61,100	77,000	98,700	32,900	48,200	64,100	80,000	101,700	119,700	138,200	152,700
~300	33,600	49,400	66,700	83,900	107,600	36,600	52,400	69,700	86,900	110,600	130,000	150,100	170,200

※ 出窓の場合はコーナー1ヶ所につきコード式は3,500円、ドラム式は4,500円プラスになります。

TM-54368



巾 ◇ 150cm 価格 ◇ 3,150円/m
組成 ◇ ポリエステル100%

リポート ◇ タテ cm ヨコ cm
寸法変化率 ◇ 水洗い/タテ 0.0% ヨコ -0.2%
ドライ/タテ 0.7% ヨコ 0.0%

取扱い表示 ◇ リ-30 30 30 30 30 30 30
防炎性能 ◇ (イ) あて布使用
Made in Japan

H	W	~67 1巾(片開き)	~150 2巾	~225 3巾	~300 4巾	~375 5巾	~450 6巾	~525 7巾	~600 8巾
~100		7,000	13,900	20,800	27,800	34,700	41,600	48,600	55,500
~120		8,000	15,900	23,800	31,700	39,600	47,600	55,500	63,400
~140		9,000	17,900	26,800	35,700	44,600	53,500	62,400	71,300
~160		9,900	19,800	29,700	39,600	49,500	59,400	69,300	79,200
~180		10,900	21,800	32,700	43,600	54,500	65,400	76,300	87,200
~200		11,900	23,800	35,700	47,600	59,400	71,300	83,200	95,100
~220		12,900	25,800	38,700	51,500	64,400	77,300	90,100	103,000
~240		13,900	27,800	41,600	55,500	69,300	83,200	97,100	110,900
~260		14,900	29,700	44,600	59,400	74,300	89,100	104,000	118,800
~280		15,900	31,700	47,600	63,400	79,200	95,100	110,900	126,800
約1.5倍ヒダ		~88	~200	~300	~400	~500	~600	~700	~800
フラット前ヒダ		~130	~260	~410	~560				

H	W	~67 1巾(片開き)	~150 2巾	~225 3巾	~300 4巾	~375 5巾	~450 6巾	~525 7巾
~100		7,400	14,700	22,100	29,400	36,800	44,100	51,500
~120		8,400	16,800	25,200	33,600	42,000	50,400	58,800
~140		9,500	18,900	28,400	37,800	47,300	56,700	66,200
~160		10,500	21,000	31,500	42,000	52,500	63,000	73,500
~180		11,600	23,100	34,700	46,200	57,800	69,300	80,900
~200		12,600	25,200	37,800	50,400	63,000	75,600	88,200
~220		13,700	27,300	41,000	54,600	68,300	81,900	95,600
~240		14,700	29,400	44,100	58,800	73,500	88,200	102,900
~260		15,800	31,500	47,300	63,000	78,800	94,500	110,300
~280		16,800	33,600	50,400	67,200	84,000	100,800	117,600
約1.5倍ヒダ		~88	~200	~300	~400	~500		

※片開きはW270cmまで

H	W	~67 1巾(片開き)	~150 2巾	~225 3巾	~300 4巾	~375 5巾	~450 6巾	~525 7巾
~100		7,800	15,600	23,400	31,100	38,900	46,700	54,400
~120		8,900	17,800	26,700	35,600	44,400	53,300	62,200
~140		10,000	20,000	30,000	40,000	50,000	60,000	70,000
~160		11,100	22,200	33,300	44,400	55,500	66,600	77,700
~180		12,300	24,500	36,700	48,900	61,100	73,300	85,500
~200		13,400	26,700	40,000	53,300	66,600	80,000	93,300
~220		14,500	28,900	43,300	57,800	72,200	86,600	101,100
~240		15,600	31,100	46,700	62,200	77,700	93,300	108,800
~260		16,700	33,300	50,000	66,600	83,300	99,900	116,600
~280		17,800	35,600	53,300	71,100	88,800	106,600	124,400
約1.5倍ヒダ		~88	~200	~300	~400	~500		

※片開きはW270cmまで

H	W	~67 1巾(片開き)	~150 2巾	~225 3巾	~300 4巾	~375 5巾	~450 6巾	~525 7巾	~600 8巾
~100		8,700	17,300	25,900	34,500	43,100	51,700	60,300	68,900
~120		9,900	19,700	29,600	39,400	49,200	59,100	68,900	78,800
~140		11,100	22,200	33,300	44,300	55,400	66,500	77,500	88,600
~160		12,300	24,600	36,900	49,200	61,500	73,800	86,100	98,400
~180		13,600	27,100	40,600	54,200	67,700	81,200	94,800	108,300
~200		14,800	29,600	44,300	59,100	73,800	88,600	103,400	118,100
~220		16,000	32,000	48,000	64,000	80,000	96,000	112,000	128,000
~240		17,300	34,500	51,700	68,900	86,100	103,400	120,600	137,800
~260		18,500	36,900	55,400	73,800	92,300	110,700	129,200	147,600

※片開きはW300cmまで

センタークロス

H	W	~80	~120	~160	~200	~240	~280	~320
~100		14,100	15,300					
~120		15,900	17,700	25,100				
~140		17,500	19,800	28,100	35,900			
~160		19,000	21,800	31,100	39,700	42,100		
~180		20,900	23,900	34,100	43,400	46,100	57,800	
~200		22,700	26,000	36,900	46,700	51,200	63,100	74,000
~220		24,500	28,000	40,000	50,700	54,300	68,100	79,000
~240		26,300	30,100	42,900	54,500	58,300	73,100	84,800
~260		28,200	33,500	46,100	58,200	62,300	78,100	89,200

H	W	~80	~120	~160	~200	~240	~280	~320
~100		16,900	18,800					
~120		18,700	21,100	29,800				
~140		20,400	23,300	32,900	42,100			
~160		22,100	25,600	36,100	46,000	48,800		
~180		24,200	27,900	39,200	49,900	53,000	66,200	
~200		26,100	30,100	42,300	53,400	58,200	71,300	83,700
~220		28,100	32,300	45,500	57,300	61,300	76,500	88,800
~240		30,100	34,600	48,600	61,200	65,500	81,700	94,800
~260		32,100	38,100	51,800	65,100	69,700	86,900	99,400

セパレーツ

H	W	~40(1P)	~50(1P)	~60(1P)
~100		13,800	15,200	16,300
~120		15,500	17,000	18,000
~140		17,200	18,600	20,000
~160		19,100	20,500	21,900
~180		20,800	22,200	23,600
~200		23,000	24,100	25,500
~220		24,500	25,700	27,100
~240		26,200	27,200	28,400
~260		28,200	29,200	30,000

スカラップM型

ウェーブ数	3W	4W	5W	6W	7W	
80~100	21,600	25,200	32,000	35,100	45,200	53,500
~120	23,700	28,100	35,700	39,000	50,200	58,900
~140	25,900	30,600	39,000	42,600	54,900	64,900
~160	28,000	32,700	41,900	45,900	59,100	70,700
~180	35,200	45,100	49,500	53,000	63,800	76,700
~200		48,400	53,100	58,400	64,900	82,900

ウェーブ数	3W	4W	5W	6W	7W	
80~100	22,300	25,900	33,000	36,100	46,500	55,000
~120	24,400	28,800	36,700	40,000	51,600	60,400
~140	26,600	31,400	40,000	43,600	56,200	66,500
~160	28,800	33,500	42,900	46,900	60,400	72,200
~180	36,000	46,200	50,500	55,100	65,100	78,300
~200		49,400	54,100	59,700	64,500	84,500

スカラップW型

ウェーブ数	2W	3W	4W	5W	6W	7W	
80~100	15,600	21,600	25,200	32,000	35,100	45,200	53,500
~120	17,200	23,700	28,100	35,700	39,000	50,200	58,900
~140	18,700	25,900	30,600	39,000	42,600	54,900	64,900
~160	20,800	32,700	41,900	45,900	59,100	70,700	
~180	35,200	45,100	49,500	53,000	63,800	76,700	
~200		48,400	53,100	58,400	64,900	82,900	

ウェーブ数	2W	3W	4W	5W	6W	7W	
80~100	16,100	22,300	25,900	33,000	36,100	46,500	55,000
~120	17,600	24,400	28,800	36,700	40,000	51,600	60,400
~140	19,200	26,600	31,400	40,000	43,600	56,200	66,500
~160	20,800	33,500	42,900	46,900	60,400	72,200	
~180	36,000	46,200	50,500	55,100	65,100	78,300	
~200		49,400	54,100	59,700	64,500	84,500	

アーチ

H	W	60~100	~130	~160	~190	~240	~290	~330
80~100		15,100	20,900	24,400	31,000	34,100	43,900	51,900
~120		16,700	23,000	27,300	34,700	38,000	48,900	57,300
~140		18,300	25,200	29,800	37,900	41,600	53,600	63,400
~160			27,300	32,000	40,900	44,900	57,800	69,100
~180				34,500	44,100	48,500	62,400	75,200
~200					47,400	52,100	67,100	81,300

H	W	60~100	~130	~160	~190	~240	~290	~330
80~100		15,500	21,400	24,900	31,700	34,800	44,800	53,000
~120		17,000	23,500	27,900	35,400	38,700	49,900	58,400
~140		18,600	25,700	30,400	38,700	42,300	53,600	64,500
~160			27,800	32,500	41,600	45,600	58,700	70,200
~180				35,000	44,900	49,200	63,400	76,300
~200					48,100	52,800	68,000	82,400

レース



style no.50 バルーンプレーン

スラッグ数 H \ W	コード式					ドラム式							
	1S	2S	3S	4S	5S	1S	2S	3S	4S	5S	6S	7S	8S
36~50	~100	~150	~200	~250		40~50	~100	~150	~200	~250	~300	~350	~400
100~140	21,100	33,400	46,500	59,600	74,400	24,100	36,400	49,500	62,600	77,400	88,300	103,200	118,000
~180	24,200	38,200	53,200	68,200	85,200	27,200	41,200	56,200	71,200	88,200	100,100	117,100	134,200
~220	27,200	43,000	59,900	76,800	96,000	30,200	46,000	62,900	79,800	99,000	111,900	131,100	150,300
~260	29,500	47,800	66,600	85,400	106,900	32,500	50,800	69,600	88,400	109,900	123,700	145,100	162,600
~300	33,400	52,600	73,400	94,100	117,700	36,400	55,600	76,400	97,100	120,700	135,500	159,100	182,700

※ 出窓の場合はコーナー1ヶ所につきコード式は3,500円、ドラム式は4,500円プラスになります。



style no.51 バルーンフリル

スラッグ数 H \ W	コード式					ドラム式							
	1S	2S	3S	4S	5S	1S	2S	3S	4S	5S	6S	7S	8S
36~50	~100	~150	~200	~250		40~50	~100	~150	~200	~250	~300	~350	~400
100~140	22,700	36,700	51,300	65,900	82,200	25,700	39,700	54,300	68,900	85,200	97,700	114,000	130,300
~180	25,700	41,500	58,000	74,500	93,000	28,700	44,500	61,000	77,500	96,000	109,500	128,000	146,500
~220	28,800	46,300	64,700	83,100	103,800	31,800	49,300	67,700	86,100	106,800	121,200	142,000	162,700
~260	31,000	51,100	71,400	91,700	114,700	34,000	54,100	74,400	94,700	117,700	133,000	155,900	174,900
~300	34,900	55,900	78,200	100,400	125,500	37,900	58,900	81,200	103,400	128,500	144,800	169,900	195,000

※ 出窓の場合はコーナー1ヶ所につきコード式は3,500円、ドラム式は4,500円プラスになります。

style no.60 プレーンシェード														
コード式						ドラム式								
H	W	30~45	~90	~140	~190	~240	30~45	~90	~140	~190	~240	~290	~340	~390
50~100		11,400	15,500	21,400	25,500	31,500	14,400	18,500	24,400	28,500	34,500	41,700	47,800	52,600
	~140	12,800	16,900	23,500	27,600	34,300	15,800	19,900	26,500	30,600	37,300	44,700	51,400	56,300
	~180	14,000	18,300	25,500	29,700	37,100	17,000	21,300	28,500	32,700	40,100	47,600	54,800	59,800
	~220	15,400	19,700	27,600	31,900	39,800	18,400	22,700	30,600	34,900	42,800	50,600	58,400	63,500
	~260	16,600	21,000	29,600	34,000	42,500	19,600	24,000	32,600	37,000	45,500	53,400	62,000	67,000
	~300	17,900	22,500	31,700	36,100	45,400	20,900	25,500	34,700	39,100	48,400	56,500	65,400	70,700

※ドラム式：仕上り巾39cm以下の場合、仕上り丈は200cmまでとなります。

スリムシェード		コード式
H	W	18~30
50~100		16,300
	~140	18,200
	~180	19,600
	~220	21,500
	~240	22,800

style no.63 シャープシェード														
コード式						ドラム式								
H	W	30~45	~90	~140	~190	~240	30~45	~90	~140	~190	~240	~290	~340	~390
50~100		14,100	20,400	28,400	35,000	42,800	17,100	23,400	31,400	38,000	45,800	54,000	62,000	68,500
	~140	15,700	22,300	31,300	38,400	47,200	18,700	25,300	34,300	41,400	50,200	58,800	67,600	74,400
	~180	17,100	24,300	34,200	41,700	51,600	20,100	27,300	37,200	44,700	54,600	63,500	73,400	80,700
	~220	18,700	26,200	37,100	45,100	56,000	21,700	29,200	40,100	48,100	59,000	68,300	78,700	86,400
	~260	20,300	28,400	40,300	49,000	61,100	23,300	31,400	43,300	52,000	64,100	73,900	85,300	93,400
	~300	22,000	30,600	43,600	52,900	66,200	25,000	33,600	46,600	55,900	69,200	79,400	91,800	100,500

※ドラム式：仕上り巾39cm以下の場合、仕上り丈は200cmまでとなります。

style no.50 バルーンプレーン														
コード式						ドラム式								
スラッグ数	1S	2S	3S	4S	5S	1S	2S	3S	4S	5S	6S	7S	8S	
H	W	36~50	~100	~150	~200	~250	40~50	~100	~150	~200	~250	~300	~350	~400
100~140		20,400	30,300	41,000	51,800	65,900	23,400	33,300	44,000	54,800	68,900	81,500	93,900	106,400
	~180	23,300	34,400	46,400	58,400	74,600	26,300	37,400	49,400	61,400	77,600	91,600	105,600	119,700
	~220	26,200	38,400	51,800	65,100	83,300	29,200	41,400	54,800	68,100	86,300	101,600	117,300	133,000
	~260	28,300	42,400	57,100	71,800	92,000	31,300	45,400	60,100	74,800	95,000	111,700	129,000	142,300
	~300	32,000	46,500	62,500	78,500	100,700	35,000	49,500	65,500	81,500	103,700	121,800	140,700	159,500

※出窓の場合はコーナー1ヶ所につきコード式は3,500円、ドラム式は4,500円プラスになります。

style no.51 バルーンフリル														
コード式						ドラム式								
スラッグ数	1S	2S	3S	4S	5S	1S	2S	3S	4S	5S	6S	7S	8S	
H	W	36~50	~100	~150	~200	~250	40~50	~100	~150	~200	~250	~300	~350	~400
100~140		21,500	32,300	43,900	55,600	70,700	24,500	35,300	46,900	58,600	73,700	87,200	100,600	114,000
	~180	24,300	36,300	49,300	62,300	79,400	27,300	39,300	52,300	65,300	82,400	97,300	112,300	127,300
	~220	27,200	40,400	54,700	69,000	88,000	30,200	43,400	57,700	72,000	91,000	107,400	124,000	140,600
	~260	29,300	44,400	60,000	75,600	96,800	32,300	47,400	63,000	78,600	99,800	117,400	135,600	149,900
	~300	33,000	48,500	65,400	82,300	105,500	36,000	51,500	68,400	85,300	108,500	127,500	147,300	167,100

※出窓の場合はコーナー1ヶ所につきコード式は3,500円、ドラム式は4,500円プラスになります。

style no.S01 ロールソフト				
スプリング・チェーンタイプ				
H	W	30~60	~80	~90
50~80		27,100	29,600	31,600
	~120	28,600	31,700	33,700
	~160	30,100	33,900	35,900
	~200	32,700	35,700	37,900
	~240		37,800	40,100

※丈は巾の3倍までが限度です。

※ロールソフト加工品は非防災品になります。

TM-54370・54371

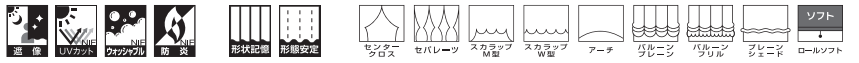

巾 ◇ 288cm ヨコ使い 価格 ◇ 9,600円/m リピート ◇ タテ12.0cm ヨコ25.2cm 取扱い表示 ◇ リ-30
 組成 ◇ ポリエステル100% 寸法変化率 ◇ 水洗い/タテ -0.5% ヨコ 0.0% 防炎性能 ◇ (イ)
 ドライ/タテ 0.0% ヨコ 0.0% Made in Japan

H	W	~50 (片開き)	~100	~150	~200	~250	~300	~350	~400
~100	12,400	23,700	35,000	46,200	57,500	68,800	80,100	91,400	
~120	12,800	24,300	35,800	47,300	58,800	70,400	81,900	93,400	
~140	13,000	24,800	36,500	48,300	60,000	71,800	83,600	95,300	
~160	13,200	25,200	37,200	49,200	61,200	73,200	85,200	97,200	
~180	13,500	25,700	38,000	50,200	62,400	74,700	86,900	99,200	
~200	13,700	26,200	38,700	51,200	63,600	76,100	88,600	101,100	
~220	14,100	26,800	39,500	52,200	65,000	77,700	90,400	103,100	
~240	14,300	27,300	40,200	53,200	66,200	79,100	92,100	105,000	
~248	14,400	27,400	40,500	53,600	66,600	79,700	92,700	105,800	
約1.5倍ヒダ	~60	~120	~200	~266	~333	~400	~466	~533	
フラット前ヒダ	~90	~160	~260	~360	~460	~560			

H	W	~50 (片開き)	~100	~150	~200	~250	~300	~350	~400
~100	13,000	24,800	36,700	48,500	60,400	72,200	84,000	95,900	
~120	13,500	25,600	37,800	50,000	62,100	74,300	86,400	98,600	
~140	13,800	26,300	38,800	51,200	63,700	76,200	88,700	101,200	
~160	14,100	26,900	39,700	52,500	65,300	78,100	90,900	103,700	
~180	14,400	27,600	40,700	53,800	66,900	80,000	93,200	106,300	
~200	14,800	28,200	41,600	55,100	68,500	82,000	95,400	108,800	
~220	15,200	29,000	42,800	56,500	70,300	84,000	97,800	111,600	
~240	15,600	29,600	43,700	57,800	71,900	86,000	100,000	114,100	
~260	15,700	29,800	44,000	58,300	72,500	86,800	100,800	115,100	
~268	15,700	29,800	44,000	58,300	72,500	86,800	100,800	115,100	
約1.5倍ヒダ	~60	~120	~200	~266	~333	~400	~466	~533	
フラット前ヒダ	~90	~160	~260	~360	~460	~560			

H	W	~50 (片開き)	~100	~150	~200	~250	~300	~350	~400
~100	12,700	24,300	35,800	47,400	58,900	70,500	82,100	93,600	
~120	13,100	25,000	36,800	48,600	60,500	72,300	84,200	96,000	
~140	13,400	25,500	37,600	49,800	61,900	74,000	86,100	98,200	
~160	13,700	26,100	38,500	50,900	63,300	75,700	88,100	100,500	
~180	14,000	26,600	39,300	52,000	64,700	77,400	90,000	102,700	
~200	14,200	27,200	40,200	53,100	66,100	79,000	92,000	105,000	
~220	14,700	27,900	41,100	54,400	67,600	80,900	94,100	107,300	
~240	14,900	28,500	42,000	55,500	69,000	82,500	96,100	109,600	
~248	15,100	28,600	42,300	55,900	69,600	83,200	96,800	110,400	
約1.5倍ヒダ	~60	~120	~200	~266	~333	~400	~466	~533	

H	W	~50 (片開き)	~100	~150	~200	~250	~300	~350	~400
~100	13,300	25,400	37,500	49,700	61,800	73,900	86,000	98,100	
~120	13,800	26,300	38,800	51,300	63,800	76,200	88,700	101,200	
~140	14,200	27,000	39,900	52,700	65,600	78,400	91,200	104,100	
~160	14,600	27,800	41,000	54,200	67,400	80,600	93,800	107,000	
~180	14,900	28,500	42,000	55,600	69,200	82,700	96,300	109,800	
~200	15,300	29,200	43,100	57,000	71,000	84,900	98,800	112,700	
~220	15,800	30,100	44,400	58,700	72,900	87,200	101,500	115,800	
~240	16,200	30,800	45,500	60,100	74,700	89,400	104,000	118,700	
~260	16,400	31,000	45,800	60,600	75,500	90,300	104,900	119,700	
~268	16,400	31,000	45,800	60,600	75,500	90,300	104,900	119,700	
約1.5倍ヒダ	~60	~120	~200	~266	~333	~400	~466	~533	

H	W	~50 (片開き)	~100	~150	~200	~250	~300	~350	~400
~100	13,000	24,800	36,700	48,500	60,400	72,200	84,000	95,900	
~120	13,500	25,600	37,800	50,000	62,100	74,300	86,400	98,600	
~140	13,800	26,300	38,800	51,200	63,700	76,200	88,700	101,200	
~160	14,100	26,900	39,700	52,500	65,300	78,100	90,900	103,700	
~180	14,400	27,600	40,700	53,800	66,900	80,000	93,200	106,300	
~200	14,800	28,200	41,600	55,100	68,500	82,000	95,400	108,800	
~220	15,200	29,000	42,800	56,500	70,300	84,000	97,800	111,600	
~240	15,600	29,600	43,700	57,800	71,900	86,000	100,000	114,100	
~248	15,700	29,800	44,000	58,300	72,500	86,800	100,800	115,100	
約1.5倍ヒダ	~60	~120	~200	~266	~333	~400	~466	~533	

H	W	~50 (片開き)	~100	~150	~200	~250	~300	~350	~400
~100	13,600	26,000	38,400	50,800	63,200	75,600	88,000	100,400	
~120	14,200	27,000	39,800	52,600	65,400	78,200	91,000	103,800	
~140	14,600	27,800	41,000	54,200	67,400	80,600	93,800	107,000	
~160	15,000	28,600	42,200	55,800	69,400	83,000	96,600	110,200	
~180	15,400	29,400	43,400	57,400	71,400	85,400	99,400	113,400	
~200	15,800	30,200	44,600	59,000	73,400	87,800	102,200	116,600	
~220	16,400	31,200	46,000	60,800	75,600	90,400	105,200	120,000	
~240	16,800	32,000	47,200	62,400	77,600	92,800	108,000	123,200	
~248	17,000	32,200	47,600	63,000	78,400	93,800	109,000	124,400	
約1.5倍ヒダ	~60	~120	~200	~266	~333	~400	~466	~533	

H	W	~80	~120	~160	~200	~240	~280	~320
~100	17,800	24,200						
~120	19,000	25,100	34,100					
~140	27,400	38,400	52,200	63,700				
~160	27,700	40,000	53,400	65,900	77,500			
~180	29,100	40,900	55,400	67,400	80,000	96,200		
~200	29,700	42,500	56,500	69,200	82,800	99,100	113,200	
~220	31,100	43,400	58,500	70,700	84,200	101,200	115,500	
~240	31,700	45,000	59,700	72,900	86,700	104,100	118,700	
~260	33,100	47,900	61,700	75,100	88,500	107,000	119,600	

H	W	~40(1P)	~50(1P)	~60(1P)
~100	17,200	19,200	22,600	
~120	18,200	20,900	23,500	
~140	24,400	27,900	32,200	
~160	26,100	29,600	33,100	
~180	27,000	31,300	34,700	
~200	28,800	32,200	36,400	
~220	29,500	33,800	37,300	
~240	31,200	34,600	38,600	
~260	33,000	36,100	39,100	

H	W	~80	~120	~160	~200	~240	~280	~320
~100	19,200	26,400						
~120	20,000	27,700	36,800					
~140	28,100	40,700	54,500	67,600				
~160	28,900	42,000	56,200	69,500	81,900			
~180	29,900	43,300	57,800	71,400	84,100	101,300		
~200	31,000	44,600	59,400	72,800	87,300	103,800	119,600	
~220	32,000	45,800	61,100	74,800	88,400	106,400	121,500	
~240	33,100	47,200	62,700	76,600	90,500	108,900	124,400	
~260	34,100	49,700	64,300	78,500	92,700	111,500	125,800	

ウェーブ数	3W	4W	5W	6W	7W
100~130	~160	~190	~240	~290	~330
80~100	27,600	36,100	42,800	54,300	67,600
~120	28,300	37,500	44,500	56,200	70,000
~140	29,100	38,600	45,700	57,800	72,000
~160	42,200	55,300	65,800	82,900	104,200
~180	56,300	67,100	84,500	106,300	122,600
~200		68,300	86,100	108,300	125,500

ウェーブ数	2W	3W	4W	5W	6W	7W
60~100	~130	~160	~190	~240	~290	~330
80~100	21,800	27,600	36,100	42,800	54,300	67,600
~120	22,400	28,300	37,500	44,500	56,200	70,000
~140	23,000	29,100	38,600	45,700	57,800	72,000
~160		42,200	55,300	65,800	82,900	104,200
~180			56,300	67,100	84,500	106,300
~200				68,300	86,100	108,300

ウェーブ数	60~100	~130	~160	~190	~240	~290	~330
80~100	21,100	26,900	35,400	41,300	52,800	66,000	74,900
~120	21,700	27,600	36,800	42,900	54,700	68,400	77,100
~140	22,300	28,300	37,800	44,200	56,300	70,400	80,000
~160		41,500					

		style no.60 プレーンシェード												
		コード式					ドラム式							
H	W	30~45	~90	~140	~190	~240	30~45	~90	~140	~190	~240	~290	~340	~390
50~100		20,200	24,100	28,600	32,600	37,300	23,200	27,100	31,600	35,600	40,300	57,500	62,200	67,000
	~140	25,300	29,200	33,900	37,900	42,800	28,300	32,200	36,900	40,900	45,800	67,400	72,300	77,200
	~180	29,500	33,400	38,400	42,300	47,400	32,500	36,400	41,400	45,300	50,400	74,700	79,700	84,700
	~220	32,900	36,800	42,000	46,000	51,300	35,900	39,800	45,000	49,000	54,300	82,200	87,300	92,400
	~260	37,900	41,900	47,300	51,200	56,800	40,900	44,900	50,300	54,200	59,800	91,900	97,400	102,400
	~268	42,200	46,100	51,700	55,700	61,500	45,200	49,100	54,700	58,700	64,500	99,400	104,700	110,100

※ドラム式：仕上り巾39cm以下の場合、仕上り丈は200cmまでとなります。

		スリムシェード	
		コード式	
H	W	18~30	
50~100		24,300	
	~140	29,600	
	~180	33,700	
	~220	37,500	
	~240	40,800	

		style no.50 バルーンプレーン												
		コード式					ドラム式							
		1S	2S	3S	4S	5S	1S	2S	3S	4S	5S	6S	7S	8S
H	W	36~50	~100	~150	~200	~250	40~50	~100	~150	~200	~250	~300	~350	~400
100~140		27,100	45,300	64,300	83,400	104,200	30,100	48,300	67,300	86,400	107,200	128,100	148,900	169,600
	~180	29,100	48,100	68,000	88,000	109,900	32,100	51,100	71,000	91,000	112,900	134,800	156,800	178,800
	~220	31,200	50,900	71,700	92,600	115,700	34,200	53,900	74,700	95,600	118,700	141,600	164,700	187,900
	~260	32,400	53,700	75,400	97,200	121,500	35,400	56,700	78,400	100,200	124,500	148,300	172,700	193,000
	~268	35,300	56,500	79,100	101,800	127,300	38,300	59,500	82,100	104,800	130,300	155,100	180,600	206,100

※出窓の場合はコーナー1ヶ所につきコード式は3,500円、ドラム式は4,500円プラスになります。

		style no.51 バルーンフリル												
		コード式					ドラム式							
		1S	2S	3S	4S	5S	1S	2S	3S	4S	5S	6S	7S	8S
H	W	36~50	~100	~150	~200	~250	40~50	~100	~150	~200	~250	~300	~350	~400
100~140		30,200	50,700	72,000	93,400	116,400	33,200	53,700	75,000	96,400	119,400	142,700	166,500	189,600
	~180	32,200	53,500	75,700	98,000	122,200	35,200	56,500	78,700	101,000	125,200	149,400	174,500	198,700
	~220	34,200	56,300	79,400	102,600	128,000	37,200	59,300	82,400	105,600	131,000	156,200	182,400	207,900
	~260	35,500	59,100	83,100	107,100	133,800	38,500	62,100	86,100	110,100	136,800	162,900	190,300	213,000
	~268	38,400	61,900	86,800	111,700	139,600	41,400	64,900	89,800	114,700	142,600	169,700	198,300	226,100

※出窓の場合はコーナー1ヶ所につきコード式は3,500円、ドラム式は4,500円プラスになります。

		style no.S01 ロールソフト							
		スプリング・チェーンタイプ							
H	W	30~60	~80	~100	~120	~140	~160	~180	~190
50~80		35,100	37,600	39,600	40,800	42,500	45,000	47,600	50,100
	~120	40,000	43,100	45,100	46,200	48,100	50,600	53,000	55,600
	~160	44,200	48,000	50,000	51,200	52,500	54,900	57,400	59,900
	~200	48,700	51,700	53,900	55,100	56,400	59,000	61,500	64,000
	~240		57,100	59,400	60,600	62,000	64,500	67,000	69,600

※丈は巾の3倍までが限度です。

※ロールソフト加工品は非防炎品になります。

style no.60 プレーンシェード														
コード式						ドラム式								
H	W	30~45	~90	~140	~190	~240	30~45	~90	~140	~190	~240	~290	~340	~390
50~100		15,400	19,400	24,000	28,100	32,700	18,400	22,400	27,000	31,100	35,700	42,900	53,000	57,800
	~140	18,100	22,200	26,900	31,000	35,900	21,100	25,200	29,900	34,000	38,900	46,400	58,300	63,200
	~180	20,700	24,800	29,800	33,900	39,100	23,700	27,800	32,800	36,900	42,100	49,600	63,400	68,400
	~220	23,400	27,500	32,700	36,900	42,200	26,400	30,500	35,700	39,900	45,200	53,100	68,700	73,800
	~260	26,000	30,200	35,600	39,800	45,400	29,000	33,200	38,600	42,800	48,400	56,300	74,000	79,000
	~280	28,600	32,900	38,500	42,800	48,600	31,600	35,900	41,500	45,800	51,600	59,800	79,200	84,500

※ドラム式：仕上り巾39cm以下の場合、仕上り丈は200cmまでとなります。

スリムシェード		コード式
H	W	18~30
50~100		19,900
	~140	23,100
	~180	25,700
	~220	28,800
	~240	30,700

style no.63 シャープシェード														
コード式						ドラム式								
H	W	30~45	~90	~140	~190	~240	30~45	~90	~140	~190	~240	~290	~340	~390
50~100		18,200	24,500	31,100	37,700	44,100	21,200	27,500	34,100	40,700	47,100	55,300	67,400	73,900
	~140	21,100	27,800	34,900	42,000	48,900	24,100	30,800	37,900	45,000	51,900	60,500	74,800	81,600
	~180	24,000	31,100	38,700	46,200	53,800	27,000	34,100	41,700	49,200	56,800	65,700	82,400	89,700
	~220	26,900	34,400	42,500	50,500	58,600	29,900	37,400	45,500	53,500	61,600	70,900	89,500	97,200
	~260	29,900	38,000	46,600	55,300	64,100	32,900	41,000	49,600	58,300	67,100	76,900	97,900	106,000
	~280	32,900	41,600	50,800	60,100	69,600	35,900	44,600	53,800	63,100	72,600	82,900	106,200	114,900

※ドラム式：仕上り巾39cm以下の場合、仕上り丈は200cmまでとなります。

style no.50 バルーンプレーン														
コード式							ドラム式							
スラッグ数	1S	2S	3S	4S	5S		1S	2S	3S	4S	5S	6S	7S	8S
H	W	36~50	~100	~150	~200	~250	40~50	~100	~150	~200	~250	~300	~350	~400
100~140		22,400	35,900	50,300	64,700	80,800	25,400	38,900	53,300	67,700	83,800	100,000	116,100	132,200
	~180	24,400	38,700	54,000	69,300	86,500	27,400	41,700	57,000	72,300	89,500	106,800	124,000	141,300
	~220	26,500	41,500	57,700	73,900	92,300	29,500	44,500	60,700	76,900	95,300	113,500	132,000	150,400
	~260	27,800	44,300	61,400	78,400	98,100	30,800	47,300	64,400	81,400	101,100	120,300	139,900	155,600
	~280	30,600	47,100	65,100	83,000	103,900	33,600	50,100	68,100	86,000	106,900	127,000	147,800	168,700

※出窓の場合はコーナー1ヶ所につきコード式は3,500円、ドラム式は4,500円プラスになります。

style no.51 バルーンフリル														
コード式							ドラム式							
スラッグ数	1S	2S	3S	4S	5S		1S	2S	3S	4S	5S	6S	7S	8S
H	W	36~50	~100	~150	~200	~250	40~50	~100	~150	~200	~250	~300	~350	~400
100~140		23,600	38,400	54,400	70,000	87,300	26,600	41,400	57,400	73,000	90,300	107,700	125,100	142,400
	~180	25,700	41,200	58,100	74,600	93,100	28,700	44,200	61,100	77,600	96,100	114,500	133,000	151,500
	~220	27,700	44,000	61,800	79,200	98,800	30,700	47,000	64,800	82,200	101,800	121,200	140,900	160,600
	~260	29,000	46,800	65,500	83,700	104,600	32,000	49,800	68,500	86,700	107,600	128,000	148,900	165,800
	~280	31,800	49,600	69,200	88,300	110,400	34,800	52,600	72,200	91,300	113,400	134,700	156,800	178,900

※出窓の場合はコーナー1ヶ所につきコード式は3,500円、ドラム式は4,500円プラスになります。

style no.S01 ロールソフト									
スプリング・チェーンタイプ									
H	W	30~60	~80	~100	~120	~140	~160	~180	~190
50~80		30,700	33,200	35,200	36,400	38,100	40,600	43,200	45,700
	~120	33,500	36,600	38,600	39,700	41,600	44,100	46,500	49,100
	~160	36,200	40,000	42,000	43,200	44,500	46,900	49,400	51,900
	~200	40,000	43,000	45,200	46,400	47,700	50,300	52,800	55,300
	~240		46,300	48,600	49,800	51,200	53,700	56,200	58,800

※丈は巾の3倍までが限度です。

※ロールソフト加工品は非防炎品になります。

TM-54373・54374

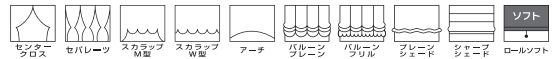

巾 ◇ 300cm ヨコ使い 価格 ◇ 6,000円/m リピート ◇ タテ cm ヨコ 1.6 cm 取扱い表示 ◇ リ-30 組成 ◇ ポリエステル100% 寸法変化率 ◇ 水洗い/タテ 0.0% ヨコ 0.0% 防炎性能 ◇ (イ) あて布使用
 ドライ/タテ 0.0% ヨコ 0.0% Made in Japan

H	W	~50 (片開き)	~100	~150	~200	~250	~300	~350	~400
~100		8,400	16,100	23,800	31,500	39,200	46,800	54,500	62,200
~120		8,800	16,700	24,600	32,600	40,500	48,400	56,300	64,200
~140		9,000	17,200	25,400	33,500	41,700	49,800	58,000	66,200
~160		9,300	17,700	26,100	34,500	42,900	51,300	59,700	68,100
~180		9,500	18,200	26,800	35,400	44,100	52,700	61,400	70,000
~200		9,800	18,600	27,500	36,400	45,300	54,200	63,000	71,900
~220		10,100	19,200	28,400	37,500	46,600	55,700	64,800	74,000
~240		10,400	19,700	29,100	38,400	47,800	57,200	66,500	75,900
~260		10,600	20,200	29,800	39,400	49,000	58,600	68,200	77,800
約1.5倍ヒダ	~60	~120	~200	~266	~333	~400	~466	~533	
フラット前ヒダ	~90	~160	~260	~360	~460	~560			

H	W	~50 (片開き)	~100	~150	~200	~250	~300	~350	~400
~100		9,000	17,300	25,500	33,800	42,000	50,200	58,500	66,700
~120		9,500	18,100	26,600	35,200	43,800	52,300	60,900	69,400
~140		9,800	18,700	27,600	36,500	45,400	54,200	63,100	72,000
~160		10,200	19,400	28,600	37,800	47,000	56,200	65,400	74,600
~180		10,500	20,000	29,500	39,000	48,600	58,100	67,600	77,100
~200		10,800	20,600	30,500	40,300	50,200	60,000	69,800	79,700
~220		11,300	21,400	31,600	41,800	51,900	62,100	72,200	82,400
~240		11,600	22,100	32,600	43,000	53,500	64,000	74,500	85,000
~260		11,900	22,700	33,500	44,300	55,100	65,900	76,700	87,500
~280		11,900	22,700	33,500	44,300	55,100	65,900	76,700	87,500
約1.5倍ヒダ	~60	~120	~200	~266	~333	~400	~466	~533	
フラット前ヒダ	~90	~160	~260	~360	~460	~560			

H	W	~50 (片開き)	~100	~150	~200	~250	~300	~350	~400
~100		8,700	16,700	24,700	32,600	40,600	48,500	56,500	64,500
~120		9,200	17,400	25,600	33,900	42,100	50,400	58,600	66,800
~140		9,400	18,000	26,500	35,000	43,500	52,000	60,600	69,100
~160		9,700	18,500	27,300	36,100	44,900	53,700	62,500	71,300
~180		10,000	19,100	28,200	37,200	46,300	55,400	64,500	73,600
~200		10,300	19,600	29,000	38,400	47,700	57,100	66,400	75,800
~220		10,700	20,300	30,000	39,600	49,300	58,900	68,500	78,200
~240		11,000	20,900	30,800	40,700	50,700	60,600	70,500	80,400
~260		11,300	21,500	31,700	41,900	52,100	62,300	72,500	82,700
約1.5倍ヒダ	~60	~120	~200	~266	~333	~400	~466	~533	

H	W	~50 (片開き)	~100	~150	~200	~250	~300	~350	~400
~100		9,300	17,900	26,400	34,900	43,400	51,900	60,500	69,000
~120		9,900	18,800	27,600	36,500	45,400	54,300	63,200	72,000
~140		10,200	19,500	28,700	38,000	47,200	56,400	65,700	74,900
~160		10,600	20,200	29,800	39,400	49,000	58,600	68,200	77,800
~180		11,000	20,900	30,900	40,800	50,800	60,800	70,700	80,700
~200		11,300	21,600	32,000	42,300	52,600	62,900	73,200	83,600
~220		11,900	22,500	33,200	43,900	54,600	65,300	75,900	86,600
~240		12,200	23,300	34,300	45,300	56,400	67,400	78,500	89,500
~260		12,600	24,000	35,400	46,800	58,200	69,600	81,000	92,400
~280		12,600	24,000	35,400	46,800	58,200	69,600	81,000	92,400
約1.5倍ヒダ	~60	~120	~200	~266	~333	~400	~466	~533	

H	W	~50 (片開き)	~100	~150	~200	~250	~300	~350	~400
~100		9,000	17,300	25,500	33,800	42,000	50,200	58,500	66,700
~120		9,500	18,100	26,600	35,200	43,800	52,300	60,900	69,400
~140		9,800	18,700	27,600	36,500	45,400	54,200	63,100	72,000
~160		10,200	19,400	28,600	37,800	47,000	56,200	65,400	74,600
~180		10,500	20,000	29,500	39,000	48,600	58,100	67,600	77,100
~200		10,800	20,600	30,500	40,300	50,200	60,000	69,800	79,700
~220		11,300	21,400	31,600	41,800	51,900	62,100	72,200	82,400
~240		11,600	22,100	32,600	43,000	53,500	64,000	74,500	85,000
~260		11,900	22,700	33,500	44,300	55,100	65,900	76,700	87,500
約1.5倍ヒダ	~60	~120	~200	~266	~333	~400	~466	~533	

H	W	~50 (片開き)	~100	~150	~200	~250	~300	~350	~400
~100		9,600	18,400	27,200	36,000	44,800	53,600	62,400	71,200
~120		10,200	19,400	28,600	37,800	47,000	56,200	65,400	74,600
~140		10,600	20,200	29,800	39,400	49,000	58,600	68,200	77,800
~160		11,000	21,000	31,000	41,000	51,000	61,000	71,000	81,000
~180		11,400	21,800	32,200	42,600	53,000	63,400	73,800	84,200
~200		11,800	22,600	33,400	44,200	55,000	65,800	76,600	87,400
~220		12,400	23,600	34,800	46,000	57,200	68,400	79,600	90,800
~240		12,800	24,400	36,000	47,600	59,200	70,800	82,400	94,000
~260		13,200	25,200	37,200	49,200	61,200	73,200	85,200	97,200
約1.5倍ヒダ	~60	~120	~200	~266	~333	~400	~466	~533	

H	W	~80	~120	~160	~200	~240	~280	~320
~100		13,200	17,700					
~120		14,100	18,600	25,100				
~140		14,400	19,900	26,300	32,800			
~160		19,800	28,100	38,100	46,700	55,400		
~180		20,400	29,400	39,300	48,700	57,100	69,300	
~200		21,500	30,300	40,900	49,700	60,400	71,400	82,300
~220		22,100	31,600	42,200	51,700	61,000	74,000	83,800
~240		23,200	32,500	43,900	53,100	63,200	76,100	86,700
~260		24,300	35,100	45,500	55,000	65,000	78,700	87,700

H	W	~40(1P)	~50(1P)	~60(1P)
~100		13,800	15,400	17,500
~120		14,700	16,900	18,900
~140		16,100	17,800	20,400
~160		19,900	23,000	25,600
~180		21,300	23,900	27,000
~200		22,300	25,300	27,800
~220		23,500	26,100	29,200
~240		24,900	27,400	29,800
~260		25,900	28,600	30,800

H	W	~80	~120	~160	~200	~240	~280	~320
~100		15,900	21,500					
~120		16,800	22,800	30,200				
~140		17,600	24,100	31,800	39,200			
~160		22,900	32,700	43,500	53,600	62,900		
~180		23,900	34,000	45,200	55,500	65,100	78,300	
~200		25,000	35,300	46,700	57,000	68,300	80,800	93,000
~220		26,000	36,500	48,400	58,900	69,400	83,400	94,900
~240		27,000	37,900	50,000	60,800	71,500	85,900	97,800
~260		28,100	40,400	51,600	62,700	73,700	88,500	99,200

ウェーブ数	3W	4W	5W	6W	7W
100~130	~160	~190	~240	~290	~330
80~100	17,500	22,800	27,700	34,100	43,800
~120	20,500	27,600	33,200	41,300	52,200
~140	21,200	28,600	34,500	43,000	54,200
~160	29,700	39,300	47,400	59,100	74,900
~180	40,300	48,700	60,700	76,900	88,800
~200		49,900	62,300	78,900	91,800

ウェーブ数	2W	3W	4W	5W	6W	7W
60~100	~130	~160	~190	~240	~290	~330
80~100	13,800	17,500	22,800	27,700	34,100	43,800
~120	16,200	20,500	27,600	33,200	41,300	52,200
~140	16,800	21,200	28,600	34,500	43,000	54,200
~160		29,700	39,300	47,400	59,100	74,900
~180		40,300	48,700	60,700	76,900	88,800
~200			49,900	62,300	78,900	91,800

H	W	60~100	~130	~160	~190	~240	~290	~330
80~100		13,400	17,100	22,300	26,800	33,200	42,200	48,000
~120		15,800	20,000	27,100	32,300	40,400	50,700	57,300
~140		16,400	20,800	28,100	33,500	42,000	52,700	60,200
~160			29,200	38,800	46,400	58,100	73,400	84,400

style no.60 プレーンシェード														
コード式						ドラム式								
H	W	30~45	~90	~140	~190	~240	30~45	~90	~140	~190	~240	~290	~340	~390
50~100		16,400	20,400	24,900	29,000	33,600	19,400	23,400	27,900	32,000	36,600	43,800	54,800	59,600
	~140	19,400	23,400	28,100	32,200	37,200	22,400	26,400	31,100	35,200	40,200	47,600	60,800	65,700
	~180	22,300	26,300	31,400	35,500	40,600	25,300	29,300	34,400	38,500	43,600	51,200	66,500	71,500
	~220	25,300	29,400	34,600	38,700	44,100	28,300	32,400	37,600	41,700	47,100	54,900	72,400	77,500
	~260	28,200	32,400	37,800	42,000	47,500	31,200	35,400	40,800	45,000	50,500	58,500	78,400	83,400
	~280	31,200	35,400	41,000	45,200	51,000	34,200	38,400	44,000	48,200	54,000	62,200	84,100	89,500

※ドラム式：仕上り巾39cm以下の場合、仕上り丈は200cmまでとなります。

スリムシェード		コード式
H	W	18~30
50~100		20,800
	~140	24,200
	~180	27,100
	~220	30,600
	~240	32,500

style no.63 シャープシェード														
コード式						ドラム式								
H	W	30~45	~90	~140	~190	~240	30~45	~90	~140	~190	~240	~290	~340	~390
50~100		19,200	25,500	32,100	38,700	45,100	22,200	28,500	35,100	41,700	48,100	56,200	69,300	75,900
	~140	22,400	29,100	36,200	43,300	50,200	25,400	32,100	39,200	46,300	53,200	61,800	77,300	84,200
	~180	25,600	32,700	40,300	47,900	55,400	28,600	35,700	43,300	50,900	58,400	67,300	85,600	92,900
	~220	28,800	36,400	44,400	52,400	60,600	31,800	39,400	47,400	55,400	63,600	72,800	93,400	101,100
	~260	32,100	40,300	48,900	57,600	66,400	35,100	43,300	51,900	60,600	69,400	79,200	102,400	110,600
	~280	35,500	44,200	53,400	62,700	72,200	38,500	47,200	56,400	65,700	75,200	85,500	111,400	120,100

※ドラム式：仕上り巾39cm以下の場合、仕上り丈は200cmまでとなります。

style no.50 バルーンブレン														
コード式							ドラム式							
スラッグ数	1S	2S	3S	4S	5S		1S	2S	3S	4S	5S	6S	7S	8S
H	W	36~50	~100	~150	~200	~250	40~50	~100	~150	~200	~250	~300	~350	~400
100~140		23,300	37,800	53,100	68,400	85,400	26,300	40,800	56,100	71,400	88,400	105,600	122,600	139,700
	~180	25,400	40,600	56,800	73,000	91,200	28,400	43,600	59,800	76,000	94,200	112,400	130,600	148,800
	~220	27,400	43,400	60,500	77,600	97,000	30,400	46,400	63,500	80,600	100,000	119,100	138,500	157,900
	~260	28,700	46,200	64,200	82,200	102,800	31,700	49,200	67,200	85,200	105,800	125,900	146,500	163,100
	~280	31,600	49,000	67,900	86,800	108,600	34,600	52,000	70,900	89,800	111,600	132,600	154,400	176,100

※出窓の場合はコーナー1ヶ所につきコード式は3,500円、ドラム式は4,500円プラスになります。

style no.51 バルーンフリル														
コード式							ドラム式							
スラッグ数	1S	2S	3S	4S	5S		1S	2S	3S	4S	5S	6S	7S	8S
H	W	36~50	~100	~150	~200	~250	40~50	~100	~150	~200	~250	~300	~350	~400
100~140		24,800	40,700	57,900	74,600	93,100	27,800	43,700	60,900	77,600	96,100	114,700	133,200	151,700
	~180	26,800	43,500	61,600	79,200	98,900	29,800	46,500	64,600	82,200	101,900	121,500	141,100	160,800
	~220	28,900	46,300	65,300	83,900	104,700	31,900	49,300	68,300	86,900	107,700	128,200	149,100	169,900
	~260	30,100	49,100	69,000	88,400	110,500	33,100	52,100	72,000	91,400	113,500	135,000	157,000	175,100
	~280	33,000	51,900	72,700	93,000	116,300	36,000	54,900	75,700	96,000	119,300	141,700	165,000	188,100

※出窓の場合はコーナー1ヶ所につきコード式は3,500円、ドラム式は4,500円プラスになります。

style no.S01 ロールソフト									
スプリング・チェーンタイプ									
H	W	30~60	~80	~100	~120	~140	~160	~180	~190
50~80		31,600	34,100	36,100	37,300	39,000	41,500	44,100	46,600
	~120	34,600	37,700	39,700	40,800	42,700	45,200	47,600	50,200
	~160	37,600	41,400	43,400	44,600	45,900	48,300	50,800	53,300
	~200	41,800	44,800	47,000	48,200	49,500	52,100	54,600	57,100
	~240		48,300	50,600	51,800	53,200	55,700	58,200	60,800

※丈は巾の3倍までが限度です。

※ロールソフト加工品は非防炎品になります。

TM-54375



巾 ◇ 148cm 価格 ◇ 4,150円/m リポート ◇ タテ cm ヨコ cm 取扱い表示 ◇ リ-30 防炎性能 ◇ (イ) あて布使用
 組成 ◇ ポリエステル100% 寸法変化率 ◇ 水洗い/タテ 0.0% ヨコ 0.0% 防炎性能 ◇ (イ) あて布使用
 ドライ/タテ 0.0% ヨコ 0.0% Made in Japan

H	W	~65 1巾(片開き)	~148 2巾	~222 3巾	~296 4巾	~370 5巾	~444 6巾	~518 7巾	~592 8巾
~100		8,400	16,600	24,900	33,200	41,600	49,800	58,100	66,400
~120		9,600	19,000	28,500	38,000	47,400	56,900	66,400	75,800
~140		10,800	21,300	32,100	42,800	53,400	64,100	74,700	85,400
~160		11,900	23,700	35,600	47,400	59,300	71,200	83,000	94,900
~180		13,100	26,100	39,200	52,200	65,300	78,200	91,300	104,300
~200		14,300	28,500	42,800	56,900	71,200	85,400	99,600	113,800
~220		15,400	30,900	46,200	61,700	77,000	92,500	107,900	123,300
~240		16,600	33,200	49,800	66,400	83,000	99,600	116,200	132,800
~260		17,800	35,600	53,400	71,200	88,900	106,700	124,500	142,200
~280		19,000	38,000	56,900	75,800	94,900	113,800	132,800	151,800
約1.5倍ヒダ		~86	~192	~296	~394	~493	~592	~690	~789
フラット前ヒダ		~128	~256	~404	~552				

H	W	~65 1巾(片開き)	~148 2巾	~222 3巾	~296 4巾	~370 5巾	~444 6巾	~518 7巾	~592 8巾
~100		8,800	17,400	26,200	34,900	43,700	52,300	61,000	69,800
~120		10,000	19,900	29,900	39,900	49,800	59,800	69,800	79,800
~140		11,300	22,400	33,700	44,900	56,000	67,300	78,400	89,500
~160		12,500	24,900	37,400	49,800	62,300	74,800	87,100	99,400
~180		13,800	27,400	41,200	54,800	68,500	82,100	95,900	109,700
~200		15,000	29,900	44,900	59,800	74,800	89,600	104,600	119,600
~220		16,200	32,400	48,500	64,800	80,900	97,100	113,200	129,400
~240		17,400	34,900	52,300	69,800	87,100	104,600	122,000	140,000
~260		18,700	37,400	56,000	74,800	93,400	112,000	130,700	151,400
~280		19,900	39,900	59,800	79,600	99,600	119,500	139,500	162,800
約1.5倍ヒダ		~86	~192	~296	~394	~493			

※片開きはW270cmまで

H	W	~65 1巾(片開き)	~148 2巾	~222 3巾	~296 4巾	~370 5巾	~444 6巾	~518 7巾
~100		9,200	18,200	27,400	36,600	45,700	54,700	63,900
~120		10,500	20,800	31,300	41,800	52,100	62,600	73,100
~140		11,800	23,500	35,300	47,000	58,700	70,500	82,100
~160		13,100	26,100	39,200	52,100	65,200	78,300	91,300
~180		14,500	28,700	43,100	57,400	71,800	86,000	100,400
~200		15,800	31,300	47,000	62,600	78,300	93,900	109,600
~220		16,900	33,900	50,800	67,800	84,700	101,700	118,600
~240		18,200	36,600	54,700	73,100	91,300	109,600	127,800
~260		19,500	39,200	58,700	78,300	97,800	117,300	137,000
~280		20,800	41,800	62,600	83,400	104,400	125,200	146,100
約1.5倍ヒダ		~86	~192	~296	~394	~493		

※片開きはW270cmまで

H	W	~65 1巾(片開き)	~148 2巾	~222 3巾	~296 4巾	~370 5巾	~444 6巾	~518 7巾	~592 8巾
~100		10,100	19,900	29,900	39,900	49,900	59,700	69,700	79,700
~120		11,500	22,700	34,200	45,600	56,800	68,300	79,700	91,000
~140		12,900	25,600	38,500	51,300	64,000	76,900	89,500	102,400
~160		14,300	28,400	42,700	56,800	71,100	85,400	99,500	113,800
~180		15,800	31,300	47,000	62,600	78,300	93,800	109,600	125,100
~200		17,200	34,200	51,300	68,300	85,400	102,400	119,600	136,500
~220		18,400	37,000	55,400	74,000	92,400	111,000	129,400	148,000
~240		19,900	39,900	59,700	79,700	99,500	119,600	139,400	159,400
~260		21,300	42,700	64,000	85,400	106,700	127,900	149,400	170,600

※片開きはW300cmまで

		コード式				ドラム式								
H	W	30~45	~90	~140	~190	30~45	~90	~140	~190	~240	~290	~340	~390	
50~100		14,400	18,500	27,300	31,300	36,000	17,400	21,500	30,300	34,300	39,000	50,500	55,300	60,100
~140		16,800	20,900	31,300	35,300	40,200	19,800	23,900	34,300	38,300	43,200	56,500	61,400	66,300
~180		19,100	23,200	35,300	39,300	44,400	22,100	26,200	38,300	42,300	47,400	62,300	67,300	72,300
~220		21,400	25,600	39,300	43,300	48,700	24,400	28,600	42,300	46,300	51,700	68,200	73,400	78,500
~260		23,600	27,900	43,300	47,400	52,900	26,600	30,900	46,300	50,400	55,900	74,000	79,500	84,500
~300		26,000	30,300	47,300	51,400	57,200	29,000	33,300	50,300	54,400	60,200	80,000	85,300	90,700

※ドラム式: 仕上り巾39cm以下の場合、仕上り丈は200cmまでとなります。

		コード式
H	W	18~30
50~100		19,000
~140		21,900
~180		24,200
~220		27,000
~240		28,700

		コード式				ドラム式								
H	W	30~45	~90	~140	~190	30~45	~90	~140	~190	~240	~290	~340	~390	
50~100		17,200	23,500	34,600	41,200	47,600	20,200	26,500	37,600	44,200	50,600	63,200	69,800	76,400
~140		19,800	26,500	39,500	46,600	53,500	22,800	29,500	42,500	49,600	56,500	71,100	78,000	84,800
~180		22,300	29,400	44,400	52,000	59,500	25,300	32,400	47,400	55,000	62,500	78,900	86,400	93,700
~220		24,800	32,400	49,400	57,400	65,500	27,800	35,400	52,400	60,400	68,500	86,800	94,400	102,100
~260		27,500	35,600	54,700	63,400	72,200	30,500	38,600	57,700	66,400	75,200	95,400	103,600	111,700
~300		30,200	38,900	60,100	69,300	78,900	33,200	41,900	63,100	72,300	81,900	104,100	112,700	121,400

※ドラム式: 仕上り巾39cm以下の場合、仕上り丈は200cmまでとなります。

		コード式					ドラム式							
スワッグ数		1S	2S	3S	4S	5S	1S	2S	3S	4S	5S	6S	7S	8S
H	W	36~50	~100	~150	~200	~250	40~50	~100	~150	~200	~250	~300	~350	~400
100~140		22,400	35,900	50,300	64,700	80,800	25,400	38,900	53,300	67,700	83,800	94,700	110,800	126,900
~180		25,800	41,400	58,000	74,600	93,200	28,800	44,400	61,000	77,600	96,200	108,100	126,700	145,400
~220		29,200	46,800	65,700	84,500	105,600	32,200	49,800	68,700	87,500	108,600	121,500	142,600	163,800
~260		31,800	52,300	73,400	94,400	118,100	34,800	55,300	76,400	97,400	121,100	134,900	158,600	178,200
~300		35,900	57,800	81,100	104,300	130,500	38,900	60,800	84,100	107,300	133,500	148,300	174,500	200,600

※出窓の場合はコーナー1ヶ所につきコード式は3,500円、ドラム式は4,500円プラスになります。

style no.60 プレーンシェード														
コード式						ドラム式								
H	W	30~45	~90	~140	~190	~240	30~45	~90	~140	~190	~240	~290	~340	~390
50~100		15,400	19,400	24,000	28,100	32,700	18,400	22,400	27,000	31,100	35,700	42,900	53,000	57,800
	~140	18,100	22,200	26,900	31,000	35,900	21,100	25,200	29,900	34,000	38,900	46,400	58,300	63,200
	~180	20,700	24,800	29,800	33,900	39,100	23,700	27,800	32,800	36,900	42,100	49,600	63,400	68,400
	~220	23,400	27,500	32,700	36,900	42,200	26,400	30,500	35,700	39,900	45,200	53,100	68,700	73,800
	~260	26,000	30,200	35,600	39,800	45,400	29,000	33,200	38,600	42,800	48,400	56,300	74,000	79,000
	~280	28,600	32,900	38,500	42,800	48,600	31,600	35,900	41,500	45,800	51,600	59,800	79,200	84,500

※ドラム式：仕上り巾39cm以下の場合、仕上り巾は200cmまでとなります。

スリムシェード		
コード式		
H	W	18~30
50~100		19,900
	~140	23,100
	~180	25,700
	~220	28,800
	~240	30,700

style no.50 バルーンプレーン														
コード式							ドラム式							
スワッグ数	1S	2S	3S	4S	5S		1S	2S	3S	4S	5S	6S	7S	8S
H	36~50	~100	~150	~200	~250		40~50	~100	~150	~200	~250	~300	~350	~400
100~140	22,400	35,900	50,300	64,700	80,800		25,400	38,900	53,300	67,700	83,800	100,000	116,100	132,200
	~180	24,400	38,700	54,000	69,300	86,500	27,400	41,700	57,000	72,300	89,500	106,800	124,000	141,300
	~220	26,500	41,500	57,700	73,900	92,300	29,500	44,500	60,700	76,900	95,300	113,500	132,000	150,400
	~260	27,800	44,300	61,400	78,400	98,100	30,800	47,300	64,400	81,400	101,100	120,300	139,900	155,600
	~280	30,600	47,100	65,100	83,000	103,900	33,600	50,100	68,100	86,000	106,900	127,000	147,800	168,700

※出窓の場合はコーナー1ヶ所につきコード式は3,500円、ドラム式は4,500円プラスになります。

style no.51 バルーンフリル														
コード式							ドラム式							
スワッグ数	1S	2S	3S	4S	5S		1S	2S	3S	4S	5S	6S	7S	8S
H	36~50	~100	~150	~200	~250		40~50	~100	~150	~200	~250	~300	~350	~400
100~140	23,600	38,400	54,400	70,000	87,300		26,600	41,400	57,400	73,000	90,300	107,700	125,100	142,400
	~180	25,700	41,200	58,100	74,600	93,100	28,700	44,200	61,100	77,600	96,100	114,500	133,000	151,500
	~220	27,700	44,000	61,800	79,200	98,800	30,700	47,000	64,800	82,200	101,800	121,200	140,900	160,600
	~260	29,000	46,800	65,500	83,700	104,600	32,000	49,800	68,500	86,700	107,600	128,000	148,900	165,800
	~280	31,800	49,600	69,200	88,300	110,400	34,800	52,600	72,200	91,300	113,400	134,700	156,800	178,900

※出窓の場合はコーナー1ヶ所につきコード式は3,500円、ドラム式は4,500円プラスになります。

style no.60 プレーンシェード														
	コード式					ドラム式								
H	W	30~45	~90	~140	~190	~240	30~45	~90	~140	~190	~240	~290	~340	~390
50~100		15,400	19,400	24,000	28,100	32,700	18,400	22,400	27,000	31,100	35,700	42,900	53,000	57,800
	~140	18,100	22,200	26,900	31,000	35,900	21,100	25,200	29,900	34,000	38,900	46,400	58,300	63,200
	~180	20,700	24,800	29,800	33,900	39,100	23,700	27,800	32,800	36,900	42,100	49,600	63,400	68,400
	~220	23,400	27,500	32,700	36,900	42,200	26,400	30,500	35,700	39,900	45,200	53,100	68,700	73,800
	~260	26,000	30,200	35,600	39,800	45,400	29,000	33,200	38,600	42,800	48,400	56,300	74,000	79,000
	~280	28,600	32,900	38,500	42,800	48,600	31,600	35,900	41,500	45,800	51,600	59,800	79,200	84,500

※ドラム式：仕上り巾39cm以下の場合、仕上り丈は200cmまでとなります。

スリムシェード		コード式
H	W	18~30
50~100		19,900
	~140	23,100
	~180	25,700
	~220	28,800
	~240	30,700

style no.63 シャープシェード														
	コード式					ドラム式								
H	W	30~45	~90	~140	~190	~240	30~45	~90	~140	~190	~240	~290	~340	~390
50~100		18,200	24,500	31,100	37,700	44,100	21,200	27,500	34,100	40,700	47,100	55,300	67,400	73,900
	~140	21,100	27,800	34,900	42,000	48,900	24,100	30,800	37,900	45,000	51,900	60,500	74,800	81,600
	~180	24,000	31,100	38,700	46,200	53,800	27,000	34,100	41,700	49,200	56,800	65,700	82,400	89,700
	~220	26,900	34,400	42,500	50,500	58,600	29,900	37,400	45,500	53,500	61,600	70,900	89,500	97,200
	~260	29,900	38,000	46,600	55,300	64,100	32,900	41,000	49,600	58,300	67,100	76,900	97,900	106,000
	~280	32,900	41,600	50,800	60,100	69,600	35,900	44,600	53,800	63,100	72,600	82,900	106,200	114,900

※ドラム式：仕上り巾39cm以下の場合、仕上り丈は200cmまでとなります。

style no.50 バルーンブレン														
	コード式					ドラム式								
スワッグ数	1S	2S	3S	4S	5S	1S	2S	3S	4S	5S	6S	7S	8S	
H	W	36~50	~100	~150	~200	~250	40~50	~100	~150	~200	~250	~300	~350	~400
100~140		22,400	35,900	50,300	64,700	80,800	25,400	38,900	53,300	67,700	83,800	100,000	116,100	132,200
	~180	24,400	38,700	54,000	69,300	86,500	27,400	41,700	57,000	72,300	89,500	106,800	124,000	141,300
	~220	26,500	41,500	57,700	73,900	92,300	29,500	44,500	60,700	76,900	95,300	113,500	132,000	150,400
	~260	27,800	44,300	61,400	78,400	98,100	30,800	47,300	64,400	81,400	101,100	120,300	139,900	155,600
	~280	30,600	47,100	65,100	83,000	103,900	33,600	50,100	68,100	86,000	106,900	127,000	147,800	168,700

※出窓の場合はコーナー1ヶ所につきコード式は3,500円、ドラム式は4,500円プラスになります。

style no.51 バルーンフリル														
	コード式					ドラム式								
スワッグ数	1S	2S	3S	4S	5S	1S	2S	3S	4S	5S	6S	7S	8S	
H	W	36~50	~100	~150	~200	~250	40~50	~100	~150	~200	~250	~300	~350	~400
100~140		23,600	38,400	54,400	70,000	87,300	26,600	41,400	57,400	73,000	90,300	107,700	125,100	142,400
	~180	25,700	41,200	58,100	74,600	93,100	28,700	44,200	61,100	77,600	96,100	114,500	133,000	151,500
	~220	27,700	44,000	61,800	79,200	98,800	30,700	47,000	64,800	82,200	101,800	121,200	140,900	160,600
	~260	29,000	46,800	65,500	83,700	104,600	32,000	49,800	68,500	86,700	107,600	128,000	148,900	165,800
	~280	31,800	49,600	69,200	88,300	110,400	34,800	52,600	72,200	91,300	113,400	134,700	156,800	178,900

※出窓の場合はコーナー1ヶ所につきコード式は3,500円、ドラム式は4,500円プラスになります。

style no.S01 ロールソフト									
	スプリング・チェーンタイプ								
H	W	30~60	~80	~100	~120	~140	~160	~180	~190
50~80		30,700	33,200	35,200	36,400	38,100	40,600	43,200	45,700
	~120	33,500	36,600	38,600	39,700	41,600	44,100	46,500	49,100
	~160	36,200	40,000	42,000	43,200	44,500	46,900	49,400	51,900
	~200	40,000	43,000	45,200	46,400	47,700	50,300	52,800	55,300
	~240		46,300	48,600	49,800	51,200	53,700	56,200	58,800

※丈は巾の3倍までが限度です。
 ※ロールソフト加工品は非防災品になります。

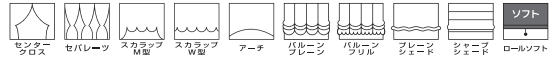

巾 ◇ 150cm 価格 ◇ 2,550円/m
組成 ◇ ポリエステル100%

リポート ◇ タテ cm ヨコ cm
寸法変化率 ◇ 水洗い/タテ -0.3% ヨコ -0.6%
ドライ/タテ -0.1% ヨコ -0.6%

取扱い表示 ◇ リ-30
防炎性能 ◇ (イ)
Made in Japan

標準仕様 レギュラー縫製仕様価格表 約2倍ヒダ (タッセルなし)

形態安定加工価格表 約2倍ヒダ (タッセルなし)

プライム縫製仕様価格表 約2倍ヒダ (タッセルなし)

形状記憶加工価格表 約2倍ヒダ (タッセルなし)

センタークロス style no.11 (タッセル含む)

セパレーツ style no.15 (タッセル含む)

レースフレンジ style no.12 (タッセル含む)

スカラップM型 style no.17

スカラップW型 style no.19

アーチ style no.26

レースフレンジ style no.27

レース

style no.60 プレーンシェード														
コード式					ドラム式									
H	W	30~45	~90	~140	~190	~240	30~45	~90	~140	~190	~240	~290	~340	~390
50~100		12,700	16,800	21,400	28,100	32,700	15,700	19,800	24,400	31,100	35,700	42,900	50,300	55,100
	~140	14,500	18,700	23,400	31,000	35,900	17,500	21,700	26,400	34,000	38,900	46,400	54,800	59,700
	~180	16,200	20,400	25,400	33,900	39,100	19,200	23,400	28,400	36,900	42,100	49,600	59,000	64,000
	~220	18,000	22,300	27,500	36,900	42,200	21,000	25,300	30,500	39,900	45,200	53,100	63,400	68,600
	~260	19,700	24,100	29,500	39,800	45,400	22,700	27,100	32,500	42,800	48,400	56,300	67,900	72,900
	~300	21,500	25,900	31,500	42,800	48,600	24,500	28,900	34,500	45,800	51,600	59,800	72,100	77,500

※ドラム式：仕上り巾39cm以下の場合、仕上り丈は200cmまでとなります。

スリムシェード	
コード式	
H	W
50~100	18~30
	17,500
	~140
	19,800
	~180
	21,600
	~220
	23,900
	~240
	25,400

style no.63 シャープシェード														
コード式					ドラム式									
H	W	30~45	~90	~140	~190	~240	30~45	~90	~140	~190	~240	~290	~340	~390
50~100		15,500	21,800	28,400	37,700	44,100	18,500	24,800	31,400	40,700	47,100	55,300	64,600	71,200
	~140	17,500	24,100	31,200	42,000	48,900	20,500	27,100	34,200	45,000	51,900	60,500	71,100	77,900
	~180	19,400	26,500	34,100	46,200	53,800	22,400	29,500	37,100	49,200	56,800	65,700	77,800	85,100
	~220	21,400	28,900	36,900	50,500	58,600	24,400	31,900	39,900	53,500	61,600	70,900	84,000	91,700
	~260	23,400	31,600	40,200	55,300	64,100	26,400	34,600	43,200	58,300	67,100	76,900	91,500	99,600
	~300	25,600	34,200	43,500	60,100	69,600	28,600	37,200	46,500	63,100	72,600	82,900	98,900	107,500

※ドラム式：仕上り巾39cm以下の場合、仕上り丈は200cmまでとなります。

style no.50 バルーンブレン														
コード式					ドラム式									
スワッグ数		1S	2S	3S	4S	5S	1S	2S	3S	4S	5S	6S	7S	8S
H	W	36~50	~100	~150	~200	~250	40~50	~100	~150	~200	~250	~300	~350	~400
100~140		20,400	31,800	44,200	56,500	70,600	23,400	34,800	47,200	59,500	73,600	84,500	98,600	112,600
	~180	23,200	36,300	50,300	64,400	80,400	26,200	39,300	53,300	67,400	83,400	95,300	111,400	127,500
	~220	26,100	40,700	56,500	72,200	90,300	29,100	43,700	59,500	75,200	93,300	106,100	124,200	142,300
	~260	28,200	45,100	62,600	80,100	100,200	31,200	48,100	65,600	83,100	103,200	117,000	137,000	153,100
	~300	31,800	49,600	68,800	87,900	110,000	34,800	52,600	71,800	90,900	113,000	127,800	149,900	171,900

※出窓の場合はコーナー1ヶ所につきコード式は3,500円、ドラム式は4,500円プラスになります。

style no.51 バルーンフリル														
コード式					ドラム式									
スワッグ数		1S	2S	3S	4S	5S	1S	2S	3S	4S	5S	6S	7S	8S
H	W	36~50	~100	~150	~200	~250	40~50	~100	~150	~200	~250	~300	~350	~400
100~140		21,600	34,500	48,000	61,600	76,900	24,600	37,500	51,000	64,600	79,900	92,000	107,300	122,600
	~180	24,400	38,900	54,200	69,500	86,700	27,400	41,900	57,200	72,500	89,700	102,900	120,200	137,500
	~220	27,300	43,400	60,300	77,300	96,600	30,300	46,400	63,300	80,300	99,600	113,700	133,000	152,300
	~260	29,400	47,800	66,500	85,200	106,500	32,400	50,800	69,500	88,200	109,500	124,500	145,800	163,100
	~300	33,100	52,200	72,600	93,000	116,300	36,100	55,200	75,600	96,000	119,300	135,300	158,700	181,900

※出窓の場合はコーナー1ヶ所につきコード式は3,500円、ドラム式は4,500円プラスになります。

style no.S01 ロールソフト						
スプリング・チェーンタイプ						
H	W	30~60	~80	~100	~120	~140
50~80		28,300	30,800	32,800	34,000	35,700
	~120	30,200	33,300	35,300	36,400	38,300
	~160	32,100	35,900	37,900	39,100	40,400
	~200	35,100	38,100	40,300	41,500	42,800
	~240		40,600	42,900	44,100	45,500

※丈は巾の3倍までが限度です。

※ロールソフト加工品は非防炎品になります。

TM-54380

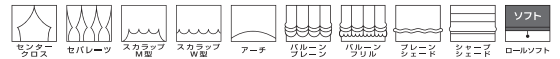

巾 ◇ 150cm 価格 ◇ 2,700円/m
組成 ◇ ポリエステル100%

リポート ◇ タテ cm ヨコ cm
寸法変化率 ◇ 水洗い/タテ 0.3% ヨコ -0.3%
ドライ/タテ 0.3% ヨコ -0.5%

取扱い表示 ◇ リ-30 40 50 60 70 80 90 100 110 120 130 140 150 160 170 180 190 200
防炎性能 ◇ (イ) 200 250 300 350 400 450 500 550 600 650 700 750 800 850 900 950 1000
Made in Japan

H \ W	~67 1巾(片開き)	~150 2巾	~225 3巾	~300 4巾	~375 5巾	~450 6巾	~525 7巾	~600 8巾
~100	6,300	12,600	18,900	25,200	31,500	37,800	44,100	50,400
~120	7,200	14,400	21,600	28,800	36,000	43,200	50,400	57,600
~140	8,100	16,200	24,300	32,400	40,500	48,600	56,700	64,800
~160	9,000	18,000	27,000	36,000	45,000	54,000	63,000	72,000
~180	9,900	19,800	29,700	39,600	49,500	59,400	69,300	79,200
~200	10,800	21,600	32,400	43,200	54,000	64,800	75,600	86,400
~220	11,700	23,400	35,100	46,800	58,500	70,200	81,900	93,600
~240	12,600	25,200	37,800	50,400	63,000	75,600	88,200	100,800
~260	13,500	27,000	40,500	54,000	67,500	81,000	94,500	108,000
~280	14,400	28,800	43,200	57,600	72,000	86,400	100,800	115,200
約1.5倍ヒダ	~88	~200	~300	~400	~500	~600	~700	~800
フラット約1倍ヒダ	~130	~260	~410	~560				

H \ W	~67 1巾(片開き)	~150 2巾	~225 3巾	~300 4巾	~375 5巾	~450 6巾	~525 7巾	~600 8巾
~100	6,800	13,500	20,200	26,900	33,600	40,400	47,100	53,800
~120	7,700	15,400	23,100	30,800	38,400	46,100	53,800	61,500
~140	8,700	17,300	26,000	34,600	43,200	51,900	60,500	69,200
~160	9,600	19,200	28,800	38,400	48,000	57,600	67,200	76,800
~180	10,600	21,200	31,700	42,300	52,800	63,400	74,000	84,600
~200	11,600	23,100	34,600	46,100	57,600	69,200	80,700	92,400
~220	12,500	25,000	37,500	50,000	62,400	74,900	87,400	100,000
~240	13,500	26,900	40,400	53,800	67,200	80,700	94,100	107,600
~260	14,400	28,800	43,200	57,600	72,000	86,400	100,800	115,200
~280	15,400	30,800	46,100	61,500	76,800	92,200	107,600	125,200
約1.5倍ヒダ	~88	~200	~300	~400	~500			

H \ W	~67 1巾(片開き)	~150 2巾	~225 3巾	~300 4巾	~375 5巾	~450 6巾	~525 7巾	~600 8巾
~100	7,200	14,300	21,500	28,600	35,700	42,900	50,000	57,100
~120	8,200	16,400	24,500	32,700	40,800	49,000	57,200	65,300
~140	9,200	18,400	27,600	36,800	45,900	55,100	64,300	73,700
~160	10,200	20,400	30,600	40,800	51,000	61,200	71,400	82,600
~180	11,300	22,500	33,700	44,900	56,100	67,400	78,600	90,800
~200	12,300	24,500	36,800	49,000	61,200	73,500	85,700	98,900
~220	13,300	26,600	39,800	53,100	66,300	79,600	92,900	107,000
~240	14,300	28,600	42,900	57,200	71,400	85,700	100,000	115,100
~260	15,300	30,600	45,900	61,200	76,500	91,800	107,100	125,200
~280	16,400	32,700	49,000	65,300	81,600	98,000	114,300	135,400
約1.5倍ヒダ	~88	~200	~300	~400	~500			

H \ W	~67 1巾(片開き)	~150 2巾	~225 3巾	~300 4巾	~375 5巾	~450 6巾	~525 7巾	~600 8巾
~100	8,000	16,000	24,000	32,000	39,900	47,900	55,900	63,900
~120	9,200	18,300	27,400	36,500	45,600	54,800	63,900	73,000
~140	10,300	20,600	30,800	41,100	51,300	61,600	71,900	82,100
~160	11,400	22,800	34,200	45,600	57,000	68,400	79,800	91,200
~180	12,600	25,100	37,700	50,200	62,700	75,300	87,800	100,400
~200	13,700	27,400	41,100	54,800	68,400	82,100	95,800	109,500
~220	14,900	29,700	44,500	59,300	74,100	89,000	103,800	118,600
~240	16,000	32,000	47,900	63,900	79,800	95,800	111,800	127,700
~260	17,100	34,200	51,300	68,400	85,500	102,600	119,700	136,800
約1.5倍ヒダ	~88	~200	~300	~400	~500			

センタークロス (タッセル含む)

H \ W	~80	~120	~160	~200	~240	~280	~320
~100	12,800	14,100					
~120	14,500	16,200	23,000				
~140	15,900	18,100	25,700	32,900			
~160	17,200	20,000	28,500	36,300	38,700		
~180	18,900	22,000	31,200	39,700	42,400	53,000	
~200	20,600	23,900	33,800	42,700	47,100	57,800	67,900
~220	22,200	25,700	36,600	46,400	49,900	62,400	72,300
~240	23,900	27,700	39,300	49,700	53,600	67,000	77,700
~260	25,500	30,900	42,200	53,100	57,300	71,600	81,600

セパレーツ (タッセル含む)

H \ W	~40(1P)	~50(1P)	~60(1P)
~100	13,000	14,400	15,500
~120	14,600	16,000	17,100
~140	16,100	17,500	18,900
~160	17,900	19,300	20,700
~180	19,500	20,900	22,200
~200	21,500	22,600	23,900
~220	22,900	24,100	25,500
~240	24,500	25,500	26,700
~260	26,300	27,400	28,100

レースフレンジ style no.12 (タッセル含む)

H \ W	~80	~120	~160	~200	~240	~280	~320
~100	16,100	18,000					
~120	17,800	20,100	28,300				
~140	19,400	22,200	31,200	39,800			
~160	20,900	24,300	34,200	43,400	46,300		
~180	22,800	26,500	37,100	47,100	50,100	62,500	
~200	24,700	28,600	40,000	50,200	55,100	67,300	78,800
~220	26,500	30,700	42,900	53,900	57,900	72,100	83,500
~240	28,400	32,800	45,900	57,500	61,800	76,900	89,000
~260	30,200	36,200	48,800	61,100	65,700	81,700	93,100

スカラップM型

ウェーブ数	3W	4W	5W	6W	7W	
H \ W	100~130	~160	~190	~240	~290	~330
80~100	19,600	23,100	29,300	32,300	41,600	49,100
~120	21,500	25,800	32,700	36,000	46,300	54,100
~140	23,500	28,100	35,600	39,300	50,500	59,700
~160	25,500	30,000	38,300	42,300	54,400	65,000
~180		32,300	41,300	45,600	58,700	70,600
~200			44,200	49,000	62,900	76,300

スカラップW型

ウェーブ数	2W	3W	4W	5W	6W	7W	
H \ W	60~100	~130	~160	~190	~240	~290	~330
80~100	14,300	19,600	23,100	29,300	32,300	41,600	49,100
~120	15,700	21,500	25,800	32,700	36,000	46,300	54,100
~140	17,200	23,500	28,100	35,600	39,300	50,500	59,700
~160		25,500	30,000	38,300	42,300	54,400	65,000
~180			32,300	41,300	45,600	58,700	70,600
~200				44,200	49,000	62,900	76,300

アーチ

H \ W	60~100	~130	~160	~190	~240	~290	~330
80~100	13,900	19,000	22,500	28,400	31,500	40,500	47,800
~120	15,300	20,900	25,200	31,800	35,100	45,100	52,700
~140	16,800	22,900	27,500	34,800	38,400	49,400	58,400
~160		24,900	29,400	37,400	41,400	53,200	63,600
~180			31,700	40,400	44,700	57,500	69,300
~200				43,400	48,100	61,800	74,900

レースフレンジ style no.18

ウェーブ数	3W	4W	5W	6W	7W	
H \ W	100~130	~160	~190	~240	~290	~330
80~100	21,200	24,700	31,400	34,500	44,400	52,500
~120	23,100	27,400	34,800	38,100	49,100	57,500
~140	25,100	29,700	37,800	41,500	53,400	63,100
~160	27,000	31,600	40,400	44,500	57,200	68,400
~180		33,900	43,400	47,800	61,500	74,000
~200			46,400	51,100	65,800	79,700

レースフレンジ style no.20

ウェーブ数	2W	3W	4W	5W	6W	7W	
H \ W	60~100	~130	~160	~190	~240	~290	~330
80~100	15,400	21,200	24,700	31,400	34,500	44,400	52,500
~120	16,800	23,100	27,400	34,800	38,100	49,100	57,500
~140	18,200	25,100	29,700	37,800	41,500	53,400	63,100
~160		27,000	31,600	40,400	44,500	57,200	68,400
~180			33,900	43,400	47,800	61,500	74,000
~200				46,400	51,100	65,800	79,700

レースフレンジ style no.27

H \ W	60~100	~130	~160	~190	~240	~290	~330
80~100	14,700	20,200	23,800	30,100	33,200	42,700	50,500
~120	16,100	22,200	26,500	33,500	36,800	47,400	55,500
~140	17,600	24,100	28,800	36,500	40,200	51,700	61,100

style no.60 プレーンシェード														
コード式					ドラム式									
H	W	30~45	~90	~140	~190	~240	30~45	~90	~140	~190	~240	~290	~340	~390
50~100		12,900	17,000	21,500	28,400	33,000	15,900	20,000	24,500	31,400	36,000	43,200	50,800	55,600
	~140	14,700	18,900	23,600	31,400	36,300	17,700	21,900	26,600	34,400	39,300	46,800	55,400	60,300
	~180	16,500	20,700	25,700	34,500	39,600	19,500	23,700	28,700	37,500	42,600	50,100	59,800	64,800
	~220	18,300	22,600	27,800	37,500	42,800	21,300	25,600	30,800	40,500	45,800	53,700	64,400	69,500
	~260	20,100	24,400	29,800	40,500	46,100	23,100	27,400	32,800	43,500	49,100	57,000	69,000	74,000
	~300	21,900	26,300	31,900	43,600	49,400	24,900	29,300	34,900	46,600	52,400	60,600	73,400	78,700

※ドラム式：仕上り巾39cm以下の場合、仕上り丈は200cmまでとなります。

スリムシェード	
コード式	
H	W
50~100	18~30
	17,600
	~140
	20,000
	~180
	21,900
	~220
	24,200
	~240
	25,700

style no.63 シャープシェード														
コード式					ドラム式									
H	W	30~45	~90	~140	~190	~240	30~45	~90	~140	~190	~240	~290	~340	~390
50~100		15,600	21,900	28,500	38,100	44,400	18,600	24,900	31,500	41,100	47,400	55,600	65,100	71,700
	~140	17,700	24,400	31,500	42,400	49,400	20,700	27,400	34,500	45,400	52,400	60,900	71,700	78,600
	~180	19,700	26,800	34,300	46,800	54,300	22,700	29,800	37,300	49,800	57,300	66,200	78,600	85,900
	~220	21,700	29,300	37,300	51,100	59,300	24,700	32,300	40,300	54,100	62,300	71,500	85,000	92,700
	~260	23,800	32,000	40,600	56,000	64,900	26,800	35,000	43,600	59,000	67,900	77,600	92,600	100,800
	~300	26,000	34,700	43,900	60,900	70,500	29,000	37,700	46,900	63,900	73,500	83,800	100,200	108,800

※ドラム式：仕上り巾39cm以下の場合、仕上り丈は200cmまでとなります。

style no.50 バルーンブレン														
コード式					ドラム式									
スワッグ数		1S	2S	3S	4S	5S	1S	2S	3S	4S	5S	6S	7S	8S
H	W	36~50	~100	~150	~200	~250	40~50	~100	~150	~200	~250	~300	~350	~400
100~140		20,600	32,200	44,700	57,300	71,500	23,600	35,200	47,700	60,300	74,500	85,500	99,700	114,000
	~180	23,500	36,800	51,000	65,300	81,600	26,500	39,800	54,000	68,300	84,600	96,500	112,800	129,100
	~220	26,400	41,300	57,300	73,400	91,700	29,400	44,300	60,300	76,400	94,700	107,600	125,900	144,300
	~260	28,500	45,800	63,600	81,400	101,800	31,500	48,800	66,600	84,400	104,800	118,700	139,100	155,500
	~300	32,200	50,300	69,900	89,500	111,900	35,200	53,300	72,900	92,500	114,900	129,700	152,200	174,600

※出窓の場合はコーナー1ヶ所につきコード式は3,500円、ドラム式は4,500円プラスになります。

style no.51 バルーンフリル														
コード式					ドラム式									
スワッグ数		1S	2S	3S	4S	5S	1S	2S	3S	4S	5S	6S	7S	8S
H	W	36~50	~100	~150	~200	~250	40~50	~100	~150	~200	~250	~300	~350	~400
100~140		21,900	35,000	48,900	62,700	78,200	24,900	38,000	51,900	65,700	81,200	93,400	109,000	124,500
	~180	24,700	39,600	55,100	70,700	88,300	27,700	42,600	58,100	73,700	91,300	104,500	122,100	139,700
	~220	27,700	44,100	61,400	78,800	98,400	30,700	47,100	64,400	81,800	101,400	115,600	135,200	154,900
	~260	29,800	48,600	67,700	86,800	108,500	32,800	51,600	70,700	89,800	111,500	126,700	148,400	166,100
	~300	33,500	53,100	74,000	94,900	118,600	36,500	56,100	77,000	97,900	121,600	137,700	161,500	185,200

※出窓の場合はコーナー1ヶ所につきコード式は3,500円、ドラム式は4,500円プラスになります。

style no.S01 ロールソフト						
スプリング・チェーンタイプ						
H	W	30~60	~80	~100	~120	~140
50~80		28,400	30,900	32,900	34,100	35,800
	~120	30,400	33,500	35,500	36,600	38,500
	~160	32,400	36,200	38,200	39,400	40,700
	~200	35,400	38,400	40,600	41,800	43,100
	~240		40,900	43,200	44,400	45,800

※丈は巾の3倍までが限度です。
 ※ロールソフト加工品は非防災品になります。

TM-54381

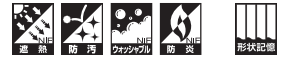

巾 ◇ 293 cm ヨコ使い 価格 ◇ 6,700 円/m リポート ◇ タテ 293.0 cm ヨコ 9.6 cm 取扱い表示 ◇ リ-30 40 炎 洗 形 記 憶
 組 成 ◇ ポリエステル100% 寸法変化率 ◇ 水洗い/タテ -0.5% ヨコ -1.5% 防炎性能 ◇ (イ) あて布使用
 ドライ/タテ -0.5% ヨコ -1.0% Made in Japan

標準仕様		レギュラー縫製仕様価格表 約2倍ヒダ (タッセルなし)							
H	W	~50 (片開き)	~100	~150	~200	~250	~300	~350	~400
~100		9,200	17,600	26,000	34,400	42,700	51,100	59,500	67,900
~120		9,600	18,200	26,800	35,400	44,100	52,700	61,300	69,900
~140		9,800	18,700	27,500	36,400	45,300	54,100	63,000	71,800
~160		10,100	19,200	28,300	37,400	46,500	55,600	64,700	73,800
~180		10,300	19,600	29,000	38,300	47,700	57,000	66,300	75,700
~200		10,500	20,100	29,700	39,300	48,900	58,400	68,000	77,600
~220		10,900	20,700	30,500	40,400	50,200	60,000	69,800	79,600
~240		11,100	21,200	31,300	41,300	51,400	61,400	71,500	81,600
~260		11,300	21,600	31,700	41,900	52,100	62,400	72,600	82,800
~273		11,300	21,600	31,700	41,900	52,100	62,400	72,600	82,800
約1.5倍ヒダ		~60	~120	~200	~266	~333	~400	~466	~533
フラット約1倍ヒダ		~90	~160	~260	~360	~460	~560		

形状記憶加工価格表 約2倍ヒダ (タッセルなし)									
H	W	~50 (片開き)	~100	~150	~200	~250	~300	~350	~400
~100		10,400	19,900	29,400	38,900	48,400	57,900	67,400	76,900
~120		11,000	20,900	30,800	40,700	50,600	60,500	70,400	80,300
~140		11,400	21,700	32,000	42,300	52,600	62,900	73,200	83,500
~160		11,800	22,500	33,200	43,900	54,600	65,300	76,000	86,700
~180		12,200	23,300	34,400	45,500	56,600	67,700	78,800	89,900
~200		12,600	24,100	35,600	47,100	58,600	70,100	81,600	93,100
~220		13,200	25,100	37,000	48,900	60,800	72,700	84,600	96,500
~240		13,600	25,900	38,200	50,500	62,800	75,100	87,400	99,700
~260		13,800	26,500	39,000	51,500	64,000	76,700	89,200	101,700

※片開きはW300cmまで

エンブroidアリー

style no.30 (両開き/タッセル含む)							
H	W	~100	~150	~200	~250	~300	~350
~273		17,900	26,900	35,700	44,700	53,500	62,500

TM-54382・54383



巾 ◇ 300cm ヨコ使い 価格 ◇ 6,200円/m リピート ◇ タテ cm ヨコ cm 取扱い表示 ◇ リ-30

組成 ◇ ポリエステル100% 寸法変化率 ◇ 水洗い/タテ 0.0% ヨコ 0.0% 防炎性能 ◇ (イ) あて布使用

ドライ/タテ 0.0% ヨコ 0.0% Made in Japan

H	W	~50 (片開き)	~100	~150	~200	~250	~300	~350	~400
~100		8,700	16,500	24,400	32,300	40,200	48,100	55,900	63,800
~120		9,000	17,100	25,300	33,400	41,500	49,600	57,700	65,900
~140		9,300	17,600	26,000	34,300	42,700	51,100	59,400	67,800
~160		9,500	18,100	26,700	35,300	43,900	52,500	61,100	69,700
~180		9,700	18,600	27,400	36,300	45,100	53,900	62,800	71,600
~200		10,000	19,100	28,100	37,200	46,300	55,400	64,500	73,500
~220		10,300	19,700	29,000	38,300	47,600	56,900	66,300	75,600
~240		10,600	20,100	29,700	39,300	48,800	58,400	67,900	77,500
~260		10,800	20,600	30,400	40,200	50,000	59,800	69,600	79,400
約1.5倍ヒダ		~60	~120	~200	~266	~333	~400	~466	~533
フラット前ヒダ		~90	~160	~260	~360	~460	~560		

H	W	~50 (片開き)	~100	~150	~200	~250	~300	~350	~400
~100		9,300	17,700	26,100	34,600	43,000	51,500	59,900	68,300
~120		9,700	18,500	27,300	36,000	44,800	53,500	62,300	71,100
~140		10,100	19,100	28,200	37,300	46,400	55,500	64,500	73,600
~160		10,400	19,800	29,200	38,600	48,000	57,400	66,800	76,200
~180		10,700	20,400	30,100	39,900	49,600	59,300	69,000	78,700
~200		11,000	21,100	31,100	41,100	51,200	61,200	71,300	81,300
~220		11,500	21,900	32,200	42,600	52,900	63,300	73,700	84,000
~240		11,800	22,500	33,200	43,900	54,500	65,200	75,900	86,600
~260		12,100	23,100	34,100	45,100	56,100	67,100	78,100	89,100
~280		12,100	23,100	34,100	45,100	56,100	67,100	78,100	89,100
約1.5倍ヒダ		~60	~120	~200	~266	~333	~400	~466	~533
フラット前ヒダ		~90	~160	~260	~360	~460	~560		

H	W	~50 (片開き)	~100	~150	~200	~250	~300	~350	~400
~100		9,000	17,100	25,300	33,400	41,600	49,800	57,900	66,100
~120		9,400	17,800	26,300	34,700	43,100	51,600	60,000	68,500
~140		9,700	18,400	27,100	35,800	44,500	53,300	62,000	70,700
~160		9,900	18,900	27,900	36,900	45,900	54,900	63,900	72,900
~180		10,200	19,500	28,800	38,100	47,300	56,600	65,900	75,200
~200		10,500	20,100	29,600	39,200	48,700	58,300	67,900	77,400
~220		10,900	20,800	30,600	40,400	50,300	60,100	70,000	79,800
~240		11,200	21,300	31,400	41,600	51,700	61,800	71,900	82,000
~260		11,500	21,900	32,300	42,700	53,100	63,500	73,900	84,300
約1.5倍ヒダ		~60	~120	~200	~266	~333	~400	~466	~533

※片開きはW270cmまで

H	W	~50 (片開き)	~100	~150	~200	~250	~300	~350	~400
~100		9,600	18,300	27,000	35,700	44,400	53,200	61,900	70,600
~120		10,100	19,200	28,300	37,300	46,400	55,500	64,600	73,700
~140		10,500	19,900	29,300	38,800	48,200	57,700	67,100	76,500
~160		10,800	20,600	30,400	40,200	50,000	59,800	69,600	79,400
~180		11,200	21,300	31,500	41,700	51,800	62,000	72,100	82,300
~200		11,500	22,100	32,600	43,100	53,600	64,100	74,700	85,200
~220		12,100	23,000	33,800	44,700	55,600	66,500	77,400	88,200
~240		12,400	23,700	34,900	46,200	57,400	68,600	79,900	91,100
~260		12,800	24,400	36,000	47,600	59,200	70,800	82,400	94,000
~280		12,800	24,400	36,000	47,600	59,200	70,800	82,400	94,000
約1.5倍ヒダ		~60	~120	~200	~266	~333	~400	~466	~533

※片開きはW270cmまで

H	W	~50 (片開き)	~100	~150	~200	~250	~300	~350	~400
~100		9,300	17,700	26,100	34,600	43,000	51,500	59,900	68,300
~120		9,700	18,500	27,300	36,000	44,800	53,500	62,300	71,100
~140		10,100	19,100	28,200	37,300	46,400	55,500	64,500	73,600
~160		10,400	19,800	29,200	38,600	48,000	57,400	66,800	76,200
~180		10,700	20,400	30,100	39,900	49,600	59,300	69,000	78,700
~200		11,000	21,100	31,100	41,100	51,200	61,200	71,300	81,300
~220		11,500	21,900	32,200	42,600	52,900	63,300	73,700	84,000
~240		11,800	22,500	33,200	43,900	54,500	65,200	75,900	86,600
~260		12,100	23,100	34,100	45,100	56,100	67,100	78,100	89,100
約1.5倍ヒダ		~60	~120	~200	~266	~333	~400	~466	~533

※片開きはW270cmまで

H	W	~50 (片開き)	~100	~150	~200	~250	~300	~350	~400
~100		9,900	18,900	27,900	36,900	45,900	54,900	63,900	72,900
~120		10,500	19,900	29,300	38,700	48,100	57,500	66,900	76,300
~140		10,900	20,700	30,500	40,300	50,100	59,900	69,700	79,500
~160		11,300	21,500	31,700	41,900	52,100	62,300	72,500	82,700
~180		11,700	22,300	32,900	43,500	54,100	64,700	75,300	85,900
~200		12,100	23,100	34,100	45,100	56,100	67,100	78,100	89,100
~220		12,700	24,100	35,500	46,900	58,300	69,700	81,100	92,500
~240		13,100	24,900	36,700	48,500	60,300	72,100	83,900	95,700
~260		13,500	25,700	37,900	50,100	62,300	74,500	86,700	98,900
約1.5倍ヒダ		~60	~120	~200	~266	~333	~400	~466	~533

※片開きはW300cmまで

共用地フリル style no.11 (タッセル含む)								
H	W	~80	~120	~160	~200	~240	~280	~320
~100		13,500	18,000					
~120		14,300	18,900	25,600				
~140		14,700	20,300	26,800	33,400			
~160		20,200	28,700	39,000	47,700	56,600		
~180		20,900	30,100	40,200	49,700	58,300	70,800	
~200		22,000	30,900	41,800	50,700	61,600	72,900	84,000
~220		22,600	32,300	43,100	52,700	62,300	75,500	85,600
~240		23,700	33,200	44,700	54,200	64,500	77,600	88,500
~260		24,800	35,800	46,400	56,100	66,200	80,200	89,400

共用地フリル style no.15 (タッセル含む)				
H	W	~40(1P)	~50(1P)	~60(1P)
~100		14,000	15,600	17,700
~120		14,900	17,100	19,200
~140		16,300	18,000	20,600
~160		20,200	23,400	26,000
~180		21,600	24,300	27,400
~200		22,600	25,700	28,300
~220		23,800	26,500	29,700
~240		25,300	27,800	30,200
~260		26,200	29,000	31,200

H	W	~80	~120	~160	~200	~240	~280	~320
~100		16,100	21,800					
~120		16,900	23,100	30,500				
~140		17,700	24,400	32,100	39,700			
~160		23,200	33,200	44,300	54,500	64,000		
~180		24,300	34,500	45,900	56,400	66,100	79,600	
~200		25,300	35,800	47,400	57,900	69,400	82,100	94,400
~220		26,300	37,000	49,100	59,800	70,500	84,700	96,400
~240		27,400	38,400	50,700	61,700	72,600	87,200	99,200
~260		28,400	40,900	52,400	63,600	74,800	89,800	100,600

共用地フリル style no.17							
ウェーブ数	3W	4W	5W	6W	7W		
~100		100~130	~160	~190	~240	~290	~330
80~100		17,800	23,200	28,200	34,800	44,500	50,400
~120		20,900	28,100	33,900	42,100	53,200	59,900
~140		21,600	29,100	35,100	43,700	55,200	62,800
~160		30,400	40,100	48,400	60,400	76,500	87,700
~180		41,100	49,700	62,000	78,600	90,600	
~200			50,900	63,600	80,600	93,600	

共用地フリル style no.19								
ウェーブ数	2W	3W	4W	5W	6W	7W		
~100		60~100	~130	~160	~190	~240	~290	~330
80~100		14,100	17,800	23,200	28,200	34,800	44,500	50,400
~120		16,500	20,900	28,100	33,900	42,100	53,200	59,900
~140		17,100	21,600	29,100	35,100	43,700	55,200	62,800
~160		30,400	40,100	48,400	60,400	76,500	87,700	
~180		41,100	49,700	62,000	78,600	90,600		
~200			50,900	63,600	80,600	93,600		

共用地フリル style no.26	
--------------------	--

style no.60 プレーンシェード														
コード式						ドラム式								
H	W	30~45	~90	~140	~190	~240	30~45	~90	~140	~190	~240	~290	~340	~390
50~100		16,600	20,600	25,100	29,200	33,800	19,600	23,600	28,100	32,200	36,800	44,000	55,200	60,000
	~140	19,700	23,700	28,400	32,500	37,400	22,700	26,700	31,400	35,500	40,400	47,900	61,300	66,200
	~180	22,700	26,700	31,700	35,800	40,900	25,700	29,700	34,700	38,800	43,900	51,500	67,200	72,200
	~220	25,700	29,800	35,000	39,100	44,500	28,700	32,800	38,000	42,100	47,500	55,300	73,200	78,400
	~260	28,700	32,800	38,300	42,400	48,000	31,700	35,800	41,300	45,400	51,000	59,000	79,300	84,300
	~280	31,700	35,900	41,600	45,700	51,500	34,700	38,900	44,600	48,700	54,500	62,800	85,200	90,600

※ドラム式：仕上り巾39cm以下の場合、仕上り丈は200cmまでとなります。

スリムシェード		コード式
H	W	18~30
50~100		21,000
	~140	24,500
	~180	27,500
	~220	31,000
	~240	32,900

style no.63 シャープシェード														
コード式						ドラム式								
H	W	30~45	~90	~140	~190	~240	30~45	~90	~140	~190	~240	~290	~340	~390
50~100		19,400	25,700	32,300	38,900	45,300	22,400	28,700	35,300	41,900	48,300	56,500	69,700	76,300
	~140	22,700	29,400	36,500	43,600	50,500	25,700	32,400	39,500	46,600	53,500	62,100	77,900	84,800
	~180	26,000	33,100	40,600	48,200	55,800	29,000	36,100	43,600	51,200	58,800	67,700	86,400	93,600
	~220	29,300	36,800	44,800	52,800	61,000	32,300	39,800	47,800	55,800	64,000	73,300	94,300	102,000
	~260	32,600	40,800	49,400	58,100	66,900	35,600	43,800	52,400	61,100	69,900	79,700	103,400	111,600
	~280	36,100	44,800	54,000	63,200	72,800	39,100	47,800	57,000	66,200	75,800	86,100	112,600	121,200

※ドラム式：仕上り巾39cm以下の場合、仕上り丈は200cmまでとなります。

style no.50 バルーンブレン														
コード式							ドラム式							
スラッグ数	1S	2S	3S	4S	5S		1S	2S	3S	4S	5S	6S	7S	8S
H	W	36~50	~100	~150	~200	~250	40~50	~100	~150	~200	~250	~300	~350	~400
100~140		23,600	38,200	53,700	69,200	86,500	26,600	41,200	56,700	72,200	89,500	106,900	124,100	141,300
	~180	25,600	41,000	57,400	73,800	92,300	28,600	44,000	60,400	76,800	95,300	113,600	132,000	150,500
	~220	27,600	43,800	61,100	78,400	98,000	30,600	46,800	64,100	81,400	101,000	120,400	140,000	159,600
	~260	28,900	46,600	64,800	83,000	103,800	31,900	49,600	67,800	86,000	106,800	127,100	147,900	164,700
	~280	31,800	49,400	68,500	87,600	109,600	34,800	52,400	71,500	90,600	112,600	133,800	155,800	177,800

※出窓の場合はコーナー1ヶ所につきコード式は3,500円、ドラム式は4,500円プラスになります。

style no.51 バルーンフリル														
コード式							ドラム式							
スラッグ数	1S	2S	3S	4S	5S		1S	2S	3S	4S	5S	6S	7S	8S
H	W	36~50	~100	~150	~200	~250	40~50	~100	~150	~200	~250	~300	~350	~400
100~140		25,000	41,200	58,700	75,700	94,400	28,000	44,200	61,700	78,700	97,400	116,300	135,000	153,700
	~180	27,100	44,000	62,400	80,300	100,200	30,100	47,000	65,400	83,300	103,200	123,100	143,000	162,900
	~220	29,100	46,800	66,100	84,900	106,000	32,100	49,800	69,100	87,900	109,000	129,800	150,900	172,000
	~260	30,400	49,600	69,800	89,500	111,800	33,400	52,600	72,800	92,500	114,800	136,500	158,800	177,100
	~280	33,300	52,400	73,500	94,100	117,500	36,300	55,400	76,500	97,100	120,500	143,300	166,800	190,200

※出窓の場合はコーナー1ヶ所につきコード式は3,500円、ドラム式は4,500円プラスになります。

style no.S01 ロールソフト									
スプリング・チェーンタイプ									
H	W	30~60	~80	~100	~120	~140	~160	~180	~190
50~80		31,800	34,300	36,300	37,500	39,200	41,700	44,300	46,800
	~120	34,900	38,000	40,000	41,100	43,000	45,500	47,900	50,500
	~160	38,000	41,800	43,800	45,000	46,300	48,700	51,200	53,700
	~200	42,200	45,200	47,400	48,600	49,900	52,500	55,000	57,500
	~240		48,700	51,000	52,200	53,600	56,100	58,600	61,200

※丈は巾の3倍までが限度です。

※ロールソフト加工品は非flammable品になります。

		style no.60 プレーンシェード												
		コード式					ドラム式							
H	W	30~45	~90	~140	~190	~240	30~45	~90	~140	~190	~240	~290	~340	~390
50~100		16,500	20,500	25,000	29,100	33,700	19,500	23,500	28,000	32,100	36,700	43,900	55,000	59,800
	~140	19,500	23,500	28,300	32,300	37,300	22,500	26,500	31,300	35,300	40,300	47,800	61,100	66,000
	~180	22,500	26,500	31,500	35,600	40,800	25,500	29,500	34,500	38,600	43,800	51,300	66,800	71,900
	~220	25,500	29,600	34,800	38,900	44,300	28,500	32,600	37,800	41,900	47,300	55,100	72,800	78,000
	~260	28,400	32,600	38,000	42,200	47,700	31,400	35,600	41,000	45,200	50,700	58,700	78,900	83,900
	~280	31,500	35,700	41,300	45,500	51,300	34,500	38,700	44,300	48,500	54,300	62,500	84,700	90,000

※ドラム式: 仕上り巾39cm以下の場合、仕上り丈は200cmまでとなります。

		スリムシェード	
		コード式	
H	W	18~30	
50~100		20,900	
	~140	24,400	
	~180	27,300	
	~220	30,800	
	~240	32,700	

		style no.50 バルーンプレーン												
		コード式					ドラム式							
		1S	2S	3S	4S	5S	1S	2S	3S	4S	5S	6S	7S	8S
H	W	36~50	~100	~150	~200	~250	40~50	~100	~150	~200	~250	~300	~350	~400
100~140		23,500	38,000	53,400	68,800	86,000	26,500	41,000	56,400	71,800	89,000	106,200	123,400	140,500
	~180	25,500	40,800	57,100	73,400	91,700	28,500	43,800	60,100	76,400	94,700	113,000	131,300	149,700
	~220	27,500	43,600	60,800	78,000	97,500	30,500	46,600	63,800	81,000	100,500	119,700	139,200	158,800
	~260	28,800	46,400	64,500	82,600	103,300	31,800	49,400	67,500	85,600	106,300	126,500	147,200	163,900
	~280	31,700	49,200	68,200	87,200	109,100	34,700	52,200	71,200	90,200	112,100	133,200	155,100	177,000

※出窓の場合はコーナー1ヶ所につきコード式は3,500円、ドラム式は4,500円プラスになります。

		style no.51 バルーンフリル												
		コード式					ドラム式							
		1S	2S	3S	4S	5S	1S	2S	3S	4S	5S	6S	7S	8S
H	W	36~50	~100	~150	~200	~250	40~50	~100	~150	~200	~250	~300	~350	~400
100~140		24,900	40,900	58,300	75,200	93,800	27,900	43,900	61,300	78,200	96,800	115,500	134,100	152,700
	~180	26,900	43,700	62,000	79,800	99,500	29,900	46,700	65,000	82,800	102,500	122,300	142,000	161,900
	~220	29,000	46,500	65,700	84,400	105,300	32,000	49,500	68,700	87,400	108,300	129,000	150,000	171,000
	~260	30,300	49,300	69,400	88,900	111,100	33,300	52,300	72,400	91,900	114,100	135,800	157,900	176,100
	~280	33,100	52,100	73,100	93,500	116,900	36,100	55,100	76,100	96,500	119,900	142,500	165,900	189,200

※出窓の場合はコーナー1ヶ所につきコード式は3,500円、ドラム式は4,500円プラスになります。

		style no.S01 ロールソフト							
		スプリング・チェーンタイプ							
H	W	30~60	~80	~100	~120	~140	~160	~180	~190
50~80		31,700	34,200	36,200	37,400	39,100	41,600	44,200	46,700
	~120	34,800	37,900	39,900	41,000	42,900	45,400	47,800	50,400
	~160	37,800	41,600	43,600	44,800	46,100	48,500	51,000	53,500
	~200	42,000	45,000	47,200	48,400	49,700	52,300	54,800	57,300
	~240		48,500	50,800	52,000	53,400	55,900	58,400	61,000

※丈は巾の3倍までが限度です。
※ロールソフト加工品は非防炎品になります。

TM-54385



巾 ◇ 150cm 価格 ◇ 4,200円/m リポート ◇ タテ 15.0cm ヨコ 75.0cm 取扱い表示 ◇ リ-30
 組成 ◇ ポリエステル100% 寸法変化率 ◇ 水洗い/タテ 0.0% ヨコ -0.5% 防炎性能 ◇ (イ) 30 30 30 30 30 30 30 30 30 30
 ドライ/タテ -0.5% ヨコ -0.5% Made in Japan

H	W	~67 1巾(片開き)	~150 2巾	~225 3巾	~300 4巾	~375 5巾	~450 6巾	~525 7巾	~600 8巾
~100		9,100	18,000	27,100	36,000	45,100	54,000	63,100	72,000
~120		10,300	19,900	30,000	39,600	49,900	59,500	69,600	79,200
~140		10,800	21,600	32,400	43,200	54,000	64,800	75,600	86,400
~160		12,700	25,200	37,900	50,400	63,100	75,600	88,300	100,800
~180		13,900	27,100	40,800	54,000	67,900	81,100	94,800	108,000
~200		14,400	28,800	43,200	57,600	72,000	86,400	100,800	115,200
~220		16,300	32,400	48,700	64,800	81,100	97,200	113,500	129,600
~240		17,500	34,300	51,600	68,400	85,900	102,700	120,000	136,800
~260		18,000	36,000	54,000	72,000	90,000	108,000	126,000	144,000
~280		19,900	39,600	59,500	79,200	99,100	118,800	138,700	158,400
約1.5倍ヒダ		~88	~200	~300	~400	~500	~600	~700	~800
フラット縫製		~130	~260	~410	~560				

H	W	~67 1巾(片開き)	~150 2巾	~225 3巾	~300 4巾	~375 5巾	~450 6巾	~525 7巾
~100		9,600	18,900	28,500	37,800	47,400	56,700	66,300
~120		10,800	20,900	31,500	41,600	52,400	62,500	73,100
~140		11,400	22,700	34,100	45,400	56,700	68,100	79,400
~160		13,300	26,500	39,800	53,000	66,300	79,400	92,700
~180		14,600	28,500	42,900	56,700	71,300	85,200	99,600
~200		15,200	30,300	45,400	60,500	75,600	90,800	105,900
~220		17,100	34,100	51,100	68,100	85,200	102,100	119,200
~240		18,400	36,000	54,200	71,900	90,200	107,800	126,000
~260		18,900	37,800	56,700	75,600	94,500	113,400	132,300
~280		20,900	41,600	62,500	83,200	104,100	124,800	145,600
約1.5倍ヒダ		~88	~200	~300	~400	~500		

H	W	~67 1巾(片開き)	~150 2巾	~225 3巾	~300 4巾	~375 5巾	~450 6巾	~525 7巾
~100		10,000	19,800	29,800	39,600	49,600	59,400	69,400
~120		11,300	21,900	33,000	43,600	54,900	65,500	76,600
~140		11,900	23,800	35,700	47,600	59,400	71,300	83,200
~160		14,000	27,800	41,700	55,500	69,400	83,200	97,100
~180		15,300	29,800	44,900	59,400	74,700	89,200	104,300
~200		15,900	31,700	47,600	63,400	79,200	95,100	110,900
~220		17,900	35,700	53,600	71,300	89,200	107,000	124,900
~240		19,300	37,700	56,800	75,300	94,500	113,000	132,000
~260		19,800	39,600	59,400	79,200	99,000	118,800	138,600
~280		21,900	43,600	65,500	87,200	109,000	130,700	152,600
約1.5倍ヒダ		~88	~200	~300	~400	~500		

H	W	~67 1巾(片開き)	~150 2巾	~225 3巾	~300 4巾	~375 5巾	~450 6巾	~525 7巾	~600 8巾
~100		10,900	21,600	32,500	43,200	54,100	64,800	75,700	86,400
~120		12,400	23,900	36,000	47,600	59,900	71,400	83,600	95,100
~140		13,000	26,000	38,900	51,900	64,800	77,800	90,800	103,700
~160		15,300	30,300	45,500	60,500	75,700	90,800	106,000	121,000
~180		16,700	32,500	49,000	64,800	81,500	97,300	113,800	129,600
~200		17,300	34,600	51,900	69,200	86,400	103,700	121,000	138,300
~220		19,600	38,900	58,500	77,800	97,300	116,700	136,200	155,600
~240		21,000	41,200	62,000	82,100	103,100	123,300	144,000	164,200
~260		21,600	43,200	64,800	86,400	108,000	129,600	151,200	172,800

		コード式				ドラム式								
H	W	30~45	~90	~140	~190	~240	30~45	~90	~140	~190	~240	~290	~340	~390
50~100		14,500	18,500	23,100	31,400	36,100	17,500	21,500	26,100	34,400	39,100	46,300	55,400	60,200
~140		17,200	21,300	26,000	35,800	40,700	20,200	24,300	29,000	38,800	43,700	51,300	62,300	67,200
~180		19,500	23,600	28,600	40,200	45,300	22,500	26,600	31,600	43,200	48,300	56,000	68,600	73,600
~220		21,500	25,700	30,900	43,500	48,900	24,500	28,700	33,900	46,500	51,900	59,900	73,700	78,800
~260		24,100	28,400	33,800	48,000	53,500	27,100	31,400	36,800	51,000	56,500	64,600	80,500	85,600
~300		26,500	30,800	36,400	52,400	58,200	29,500	33,800	39,400	55,400	61,200	69,600	86,800	92,200

		コード式
H	W	18~30
50~100		19,100
~140		22,300
~180		24,600
~220		27,100
~240		29,100

		コード式				ドラム式								
H	W	30~45	~90	~140	~190	~240	30~45	~90	~140	~190	~240	~290	~340	~390
50~100		17,300	23,500	30,200	41,300	47,700	20,300	26,500	33,200	44,300	50,700	58,800	69,900	76,500
~140		20,200	26,900	34,000	47,100	54,100	23,200	29,900	37,000	50,100	57,100	65,600	79,000	85,800
~180		22,700	29,900	37,400	52,900	60,500	25,700	32,900	40,400	55,900	63,500	72,400	87,800	95,100
~220		24,900	32,500	40,500	57,600	65,700	27,900	35,500	43,500	60,600	68,700	78,000	94,700	102,400
~260		28,000	36,100	44,800	64,000	72,800	31,000	39,100	47,800	67,000	75,800	85,600	104,700	112,800
~300		30,700	39,400	48,600	70,300	79,900	33,700	42,400	51,600	73,300	82,900	93,200	114,300	122,900

		コード式				ドラム式								
スワッグ数		1S	2S	4S	5S	1S	2S	3S	4S	5S	6S	7S	8S	
100~140		22,800	36,400	51,200	65,600	82,100	25,800	39,400	54,200	68,600	85,100	96,100	112,200	128,700
~180		26,200	42,200	59,200	76,300	95,300	29,200	45,200	62,200	79,300	98,300	110,200	129,200	148,300
~220		29,300	47,000	66,000	84,900	106,100	32,300	50,000	69,000	87,900	109,100	122,000	143,200	164,500
~260		32,200	52,900	74,400	95,500	119,600	35,200	55,900	77,400	98,500	122,600	136,500	160,200	180,400
~300		36,400	58,700	82,400	106,200	132,800	39,400	61,700	85,400	109,200	135,800	150,600	177,200	203,800

※出窓の場合はコーナー1ヶ所につきコード式は3,500円、ドラム式は4,500円プラスになります。

		スプリング・チェーンタイプ				
H	W	30~60	~80	~100	~120	~140
50~80		29,900	32,400	34,400	35,600	37,300
~120		32,700	35,800	37,800	38,900	40,800
~160		35,100	38,900	40,900	42,100	43,400
~200		38,300	41,300	43,500	44,700	46,000
~240			44,600	46,900	48,100	49,500

※丈は巾の3倍までが限度です。
 ※ロールソフト加工品は非防炎品になります。

TM-54386



巾 ◇ 100 cm 価 格 ◇ 1,800 円/m リポート ◇ タテ 1.9 cm ヨコ 1.0 cm 取扱表示 ◇ リ-30 40 防炎性能 ◇ (イ) 形態安定加工 形状記憶加工
 組成 ◇ ポリエステル100% 寸法変化率 ◇ 水洗い/タテ 0.0% ヨコ -0.5% ドライ/タテ -0.5% ヨコ 0.0% Made in Japan

H \ W	~44 1巾(片開き)	~100 2巾	~150 3巾	~200 4巾	~250 5巾	~300 6巾	~350 7巾	~400 8巾
~100	4,200	8,700	12,900	17,100	21,300	25,500	29,700	33,900
~120	5,100	9,900	14,700	19,500	24,300	29,100	33,900	39,000
~140	5,400	11,100	16,500	21,900	27,300	32,700	38,100	43,500
~160	6,300	12,300	18,300	24,300	30,300	36,300	42,300	48,600
~180	6,600	13,200	20,100	26,700	33,300	39,900	46,500	53,100
~200	7,500	14,700	21,900	29,100	36,300	43,500	50,700	57,900
~220	7,800	15,600	23,400	31,500	39,300	47,100	54,900	62,700
~240	8,700	17,100	25,500	33,900	42,300	50,700	59,100	67,500
~260	9,000	18,000	27,000	36,000	45,300	54,300	63,300	72,300
~280	9,900	19,500	29,100	38,700	48,300	57,900	67,500	77,100
約1.5倍ヒダ	~56	~120	~200	~266	~333	~400	~466	~533
フラット約1倍ヒダ	~80	~160	~260	~360	~460	~560		

H \ W	~44 1巾(片開き)	~100 2巾	~150 3巾	~200 4巾	~250 5巾	~300 6巾	~350 7巾	~400 8巾
~100	4,500	9,300	13,800	18,300	22,800	27,200	31,700	36,200
~120	5,500	10,600	15,700	20,800	26,000	31,100	36,200	41,600
~140	5,800	11,900	17,600	23,400	29,200	34,900	40,700	46,400
~160	6,800	13,200	19,600	26,000	32,400	38,800	45,200	51,900
~180	7,100	14,100	21,500	28,500	35,600	42,600	49,600	56,700
~200	8,000	15,700	23,400	31,100	38,800	46,400	54,100	61,800
~220	8,400	16,700	25,000	33,600	42,000	50,300	58,600	66,900
~240	9,300	18,300	27,200	36,200	45,200	54,100	63,100	72,000
~260	9,600	19,200	28,800	38,400	48,400	58,000	67,600	77,200
~280	10,600	20,800	31,100	41,300	51,600	61,800	72,000	82,300
約1.5倍ヒダ	~56	~120	~200	~266	~333	~400	~466	~533

※片開きはW270cmまで

H \ W	~44 1巾(片開き)	~100 2巾	~150 3巾	~200 4巾	~250 5巾	~300 6巾	~350 7巾	~400 8巾
~100	4,800	9,900	14,700	19,400	24,200	28,900	33,700	38,500
~120	5,800	11,300	16,700	22,100	27,600	33,000	38,500	44,200
~140	6,200	12,600	18,700	24,900	31,000	37,100	43,200	49,300
~160	7,200	14,000	20,800	27,600	34,400	41,200	48,000	55,100
~180	7,500	15,000	22,800	30,300	37,800	45,300	52,700	60,200
~200	8,500	16,700	24,900	33,000	41,200	49,300	57,500	65,700
~220	8,900	17,700	26,600	35,700	44,600	53,400	62,300	71,100
~240	9,900	19,400	28,900	38,500	48,000	57,500	67,000	76,500
~260	10,200	20,400	30,600	40,800	51,400	61,600	71,800	82,000
~280	11,300	22,100	33,000	43,900	54,800	65,700	76,500	87,400
約1.5倍ヒダ	~56	~120	~200	~266	~333	~400	~466	~533

※片開きはW270cmまで

H \ W	~44 1巾(片開き)	~100 2巾	~150 3巾	~200 4巾	~250 5巾	~300 6巾	~350 7巾	~400 8巾
~100	5,400	11,100	16,400	21,700	27,000	32,300	37,700	43,000
~120	6,500	12,600	18,700	24,700	30,800	36,900	43,000	49,400
~140	6,900	14,100	20,900	27,800	34,600	41,500	48,300	55,100
~160	8,000	15,600	23,200	30,800	38,400	46,000	53,600	61,600
~180	8,400	16,800	25,500	33,900	42,200	50,600	58,900	67,300
~200	9,500	18,700	27,800	36,900	46,000	55,100	64,300	73,400
~220	9,900	19,800	29,700	39,900	49,800	59,700	69,600	79,500
~240	11,100	21,700	32,300	43,000	53,600	64,300	74,900	85,500
~260	11,400	22,800	34,200	45,600	57,400	68,800	80,200	91,600

※片開きはW300cmまで

		コード式					ドラム式							
H \ W		30~45	~90	~140	~190	~240	30~45	~90	~140	~190	~240	~290	~340	~390
50~100		12,100	16,200	22,600	26,700	33,200	15,100	19,200	25,600	29,700	36,200	43,400	50,000	54,800
~140		13,600	17,800	25,000	29,100	36,500	16,600	20,800	28,000	32,100	39,500	46,900	54,300	59,200
~180		15,100	19,300	27,400	31,600	39,700	18,100	22,300	30,400	34,600	42,700	50,300	58,400	63,400
~220		16,600	20,900	29,800	34,000	43,000	19,600	23,900	32,800	37,000	46,000	53,800	62,700	67,800
~260		18,000	22,400	32,200	36,500	46,200	21,000	25,400	35,200	39,500	49,200	57,200	67,000	72,000
~300		19,500	24,000	34,600	38,900	49,500	22,500	27,000	37,600	41,900	52,500	60,800	71,100	76,400

※ドラム式: 仕上り巾39cm以下の場合、仕上り丈は200cmまでとなります。

		コード式	
H \ W		18~30	
50~100		16,900	
~140		19,000	
~180		20,600	
~220		22,600	
~240		23,800	

		コード式					ドラム式							
スワッグ数		1S	2S	3S	4S	5S	1S	2S	3S	4S	5S	6S	7S	8S
100~140		21,900	32,400	43,700	55,100	70,500	24,900	35,400	46,700	58,100	73,500	86,900	100,000	113,100
~180		25,000	36,900	49,700	62,600	80,300	28,000	39,900	52,700	65,600	83,300	98,300	113,100	128,000
~220		28,200	41,400	55,700	70,100	90,100	31,200	44,400	58,700	73,100	93,100	109,500	126,200	142,900
~260		30,700	46,000	61,700	77,500	100,000	33,700	49,000	64,700	80,500	103,000	120,800	139,200	153,800
~300		34,700	50,500	67,800	85,000	109,800	37,700	53,500	70,800	88,000	112,800	132,200	152,300	172,600

※出窓の場合はコーナー1ヶ所につきコード式は3,500円、ドラム式は4,500円プラスになります。

TM-54387



巾 ◇ 150cm 価格 ◇ 2,400円/m
組成 ◇ ポリエステル100%

リポート ◇ タテ cm ヨコ 3.3cm
寸法変化率 ◇ 水洗い/タテ 0.0% ヨコ -0.5%
ドライ/タテ -0.5% ヨコ -1.0%

取扱い表示 ◇ リ-30
防炎性能 ◇ (イ)
Made in Japan

H	W	~67 1巾(片開き)	~150 2巾	~225 3巾	~300 4巾	~375 5巾	~450 6巾	~525 7巾	~600 8巾
~100		5,900	11,800	17,700	23,600	29,400	35,300	41,200	47,100
~120		6,800	13,500	20,200	26,900	33,600	40,400	47,100	53,800
~140		7,600	15,200	22,700	30,300	37,800	45,400	53,000	60,500
~160		8,400	16,800	25,200	33,600	42,000	50,400	58,800	67,200
~180		9,300	18,500	27,800	37,000	46,200	55,500	64,700	74,000
~200		10,100	20,200	30,300	40,400	50,400	60,500	70,600	80,700
~220		11,000	21,900	32,800	43,700	54,600	65,600	76,500	87,400
~240		11,800	23,600	35,300	47,100	58,800	70,600	82,400	94,100
~260		12,600	25,200	37,800	50,400	63,000	75,600	88,200	100,800
~280		13,500	26,900	40,400	53,800	67,200	80,700	94,100	107,600
約1.5倍ヒダ		~88	~200	~300	~400	~500	~600	~700	~800
フラット前ヒダ		~130	~260	~410	~560				

H	W	~67 1巾(片開き)	~150 2巾	~225 3巾	~300 4巾	~375 5巾	~450 6巾	~525 7巾	~600 8巾
~100		6,300	12,600	18,900	25,200	31,500	37,800	44,100	
~120		7,200	14,400	21,600	28,800	36,000	43,200	50,400	
~140		8,100	16,200	24,300	32,400	40,500	48,600	56,700	
~160		9,000	18,000	27,000	36,000	45,000	54,000	63,000	
~180		9,900	19,800	29,700	39,600	49,500	59,400	69,300	
~200		10,800	21,600	32,400	43,200	54,000	64,800	75,600	
~220		11,700	23,400	35,100	46,800	58,500	70,200	81,900	
~240		12,600	25,200	37,800	50,400	63,000	75,600	88,200	
~260		13,500	27,000	40,500	54,000	67,500	81,000	94,500	
~280		14,400	28,800	43,200	57,600	72,000	86,400	100,800	
約1.5倍ヒダ		~88	~200	~300	~400	~500			

※片開きはW270cmまで

H	W	~67 1巾(片開き)	~150 2巾	~225 3巾	~300 4巾	~375 5巾	~450 6巾	~525 7巾
~100		6,800	13,500	20,200	26,900	33,600	40,400	47,100
~120		7,700	15,400	23,100	30,800	38,400	46,100	53,800
~140		8,700	17,300	26,000	34,600	43,200	51,900	60,500
~160		9,600	19,200	28,800	38,400	48,000	57,600	67,200
~180		10,600	21,200	31,700	42,300	52,800	63,400	74,000
~200		11,600	23,100	34,600	46,100	57,600	69,200	80,700
~220		12,500	25,000	37,500	50,000	62,400	74,900	87,400
~240		13,500	26,900	40,400	53,800	67,200	80,700	94,100
~260		14,400	28,800	43,200	57,600	72,000	86,400	100,800
~280		15,400	30,800	46,100	61,500	76,800	92,200	107,600
約1.5倍ヒダ		~88	~200	~300	~400	~500		

※片開きはW270cmまで

H	W	~67 1巾(片開き)	~150 2巾	~225 3巾	~300 4巾	~375 5巾	~450 6巾	~525 7巾	~600 8巾
~100		7,600	15,200	22,700	30,300	37,800	45,400	53,000	60,500
~120		8,700	17,300	26,000	34,600	43,200	51,900	60,500	69,200
~140		9,800	19,500	29,200	38,900	48,600	58,400	68,100	77,800
~160		10,800	21,600	32,400	43,200	54,000	64,800	75,600	86,400
~180		11,900	23,800	35,700	47,600	59,400	71,300	83,200	95,100
~200		13,000	26,000	38,900	51,900	64,800	77,800	90,800	103,700
~220		14,100	28,100	42,200	56,200	70,200	84,300	98,300	112,400
~240		15,200	30,300	45,400	60,500	75,600	90,800	105,900	121,000
~260		16,200	32,400	48,600	64,800	81,000	97,200	113,400	129,600

※片開きはW300cmまで

H	W	コード式					ドラム式							
		30~45	~90	~140	~190	~240	30~45	~90	~140	~190	~240	~290	~340	~390
50~100		12,600	16,700	21,200	27,800	32,400	15,600	19,700	24,200	30,800	35,400	42,600	49,900	54,700
~140		14,300	18,400	23,200	30,600	35,500	17,300	21,400	26,200	33,600	38,500	46,000	54,200	59,100
~180		16,000	20,200	25,200	33,400	38,600	19,000	23,200	28,200	36,400	41,600	49,100	58,200	63,300
~220		17,700	21,900	27,100	36,300	41,600	20,700	24,900	30,100	39,300	44,600	52,400	62,500	67,600
~260		19,300	23,700	29,100	39,100	44,700	22,300	26,700	32,100	42,100	47,700	55,600	66,800	71,800
~300		21,000	25,500	31,100	42,000	47,800	24,000	28,500	34,100	45,000	50,800	58,900	70,900	76,200

※ドラム式: 仕上り巾39cm以下の場合、仕上り丈は200cmまでとなります。

H	W	コード式
50~100		18~30
~140		17,400
~180		19,600
~220		21,400
~260		23,700
~300		25,000

H	W	コード式					ドラム式							
		1S	2S	3S	4S	5S	1S	2S	3S	4S	5S	6S	7S	8S
100~140		20,200	31,500	43,600	55,700	69,600	23,200	34,500	46,600	58,700	72,600	83,500	97,400	111,300
~180		23,000	35,800	49,600	63,400	79,200	26,000	38,800	52,600	66,400	82,200	94,100	109,900	125,800
~220		25,800	40,100	55,600	71,100	88,800	28,800	43,100	58,600	74,100	91,800	104,700	122,500	140,300
~260		27,800	44,500	61,600	78,700	98,500	30,800	47,500	64,600	81,700	101,500	115,300	135,000	150,800
~300		31,500	48,800	67,600	86,400	108,100	34,500	51,800	70,600	89,400	111,100	125,900	147,600	169,200

※出窓の場合はコーナー1ヶ所につきコード式は3,500円、ドラム式は4,500円プラスになります。

TM-54388

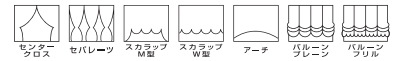
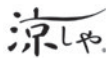

巾 ◇ 150cm 価格 ◇ 2,400円/m
組成 ◇ ポリエステル100%

リポート ◇ タテ 22.0cm ヨコ 16.5cm
寸法変化率 ◇ 水洗い/タテ -0.5% ヨコ -0.3%
ドライ/タテ -0.7% ヨコ -0.8%

取扱い表示 ◇ リ-30 40 50 60 70 80 90 100 110 120 130 140 150 160 170 180 190 200 210 220 230 240 250 260 270 280 290 300 310 320 330 340 350 360 370 380 390 400 410 420 430 440 450 460 470 480 490 500
防炎性能 ◇ (イ)
Made in Japan

H \ W	~67 1巾(片開き)	~150 2巾	~225 3巾	~300 4巾	~375 5巾	~450 6巾	~525 7巾	~600 8巾
~100	6,800	13,100	19,800	26,100	32,400	39,200	45,400	52,100
~120	7,600	15,200	22,400	29,900	37,000	44,600	52,100	59,300
~140	8,400	16,800	25,200	33,600	41,700	50,100	58,500	66,900
~160	8,400	16,800	25,200	33,600	41,700	50,100	58,500	66,900
~180	9,300	18,500	27,800	37,000	46,200	55,500	64,700	74,000
~200	10,600	20,700	30,800	40,800	50,900	61,400	71,400	81,500
~220	11,400	22,400	33,600	44,600	55,500	66,900	77,800	89,100
~240	12,300	24,400	36,200	48,400	60,200	72,300	84,500	96,300
~260	13,100	26,100	39,200	52,100	64,700	77,800	90,800	103,800
~280	14,000	27,800	41,700	55,500	69,400	83,200	97,100	110,900
約1.5倍ヒダ	~88	~200	~300	~400	~500	~600	~700	~800
フラット前ヒダ	~130	~260	~410	~560				

H \ W	~67 1巾(片開き)	~150 2巾	~225 3巾	~300 4巾	~375 5巾	~450 6巾	~525 7巾	~600 8巾
~100	7,200	14,100	21,300	27,900	34,800	42,000	48,600	55,800
~120	8,100	16,200	24,000	32,100	39,600	47,700	55,800	63,900
~140	9,000	18,000	27,000	36,000	44,700	53,700	62,700	71,700
~160	9,000	18,000	27,000	36,000	44,700	53,700	62,700	71,700
~180	9,900	19,800	29,700	39,600	49,500	59,400	69,300	79,200
~200	11,400	22,800	34,200	45,600	56,400	67,200	78,000	88,800
~220	12,300	24,600	36,900	49,200	60,300	71,400	82,500	93,600
~240	13,200	26,400	39,600	52,800	64,800	77,400	90,000	102,600
~260	14,100	28,200	42,300	56,400	69,300	83,400	97,200	111,600
~280	15,000	29,700	44,700	59,400	74,400	89,100	104,100	119,100
約1.5倍ヒダ	~88	~200	~300	~400	~500			

H \ W	~67 1巾(片開き)	~150 2巾	~225 3巾	~300 4巾	~375 5巾	~450 6巾	~525 7巾	~600 8巾
~100	7,700	15,000	22,700	29,800	37,100	44,800	51,900	59,600
~120	8,700	17,300	25,600	34,200	42,300	50,900	59,600	68,300
~140	9,600	19,200	28,800	38,400	47,600	57,200	66,800	76,400
~160	9,600	19,200	28,800	38,400	47,600	57,200	66,800	76,400
~180	10,600	21,200	31,700	42,300	52,800	63,400	74,000	84,600
~200	12,100	23,600	35,200	46,700	58,200	70,100	81,600	93,100
~220	13,100	25,600	38,400	50,900	63,400	76,400	88,900	101,400
~240	14,000	27,900	41,300	55,300	68,800	82,600	96,600	110,400
~260	15,000	29,800	44,800	59,600	74,000	88,900	103,700	119,400
~280	16,000	31,700	47,600	63,400	79,300	95,100	111,000	128,400
約1.5倍ヒダ	~88	~200	~300	~400	~500			

H \ W	~67 1巾(片開き)	~150 2巾	~225 3巾	~300 4巾	~375 5巾	~450 6巾	~525 7巾	~600 8巾
~100	8,700	16,900	25,500	33,500	41,700	50,400	58,400	67,000
~120	9,800	19,500	28,800	38,500	47,600	57,300	67,000	76,300
~140	10,800	21,600	32,400	43,200	53,600	64,400	75,200	86,000
~160	10,800	21,600	32,400	43,200	53,600	64,400	75,200	86,000
~180	11,900	23,800	35,700	47,600	59,400	71,300	83,200	95,100
~200	13,600	26,600	39,600	52,500	65,500	78,900	91,800	104,800
~220	14,700	28,800	43,200	57,300	71,300	86,000	100,000	114,500
~240	15,800	31,400	46,500	62,200	77,400	92,900	108,700	123,800
~260	16,900	33,500	50,400	67,000	83,200	100,000	116,700	133,500
約1.5倍ヒダ	~88	~200	~300	~400	~500			

H \ W	~80	~120	~160	~200	~240	~280	~320
~100	12,000	13,300					
~120	13,700	15,500	21,800				
~140	15,000	17,300	24,500	31,200			
~160	16,400	19,200	27,100	34,600	37,000		
~180	18,000	21,000	29,800	38,000	40,700	50,700	
~200	19,500	22,800	32,300	40,800	45,200	55,400	65,000
~220	21,200	24,800	35,100	44,400	48,000	59,900	69,500
~240	22,800	26,600	37,800	47,700	51,600	64,400	74,700
~260	24,500	29,800	40,500	51,100	55,300	68,900	78,500

H \ W	~40(1P)	~50(1P)	~60(1P)
~100	12,400	13,800	14,900
~120	13,900	15,300	16,400
~140	15,600	17,000	18,400
~160	17,300	18,700	20,000
~180	18,800	20,200	21,500
~200	20,800	21,800	23,100
~220	22,000	23,300	24,600
~240	23,800	24,800	25,900
~260	25,500	26,500	27,200

H \ W	~80	~120	~160	~200	~240	~280	~320
~100	15,600	17,500					
~120	17,300	19,700	27,500				
~140	18,800	21,700	30,500	38,700			
~160	20,500	23,900	33,300	42,300	45,100		
~180	22,300	25,900	36,300	45,900	49,000	60,800	
~200	24,000	27,900	39,000	48,900	53,800	65,500	76,700
~220	26,000	30,100	42,000	52,600	56,600	70,300	81,500
~240	27,800	32,200	45,000	56,200	60,500	75,100	87,000
~260	29,700	35,700	47,700	59,800	64,400	79,800	91,000

ウェーブ数	3W	4W	5W	6W	7W	
H \ W	100~130	~160	~190	~240	~290	~330
80~100	18,300	21,700	27,400	30,500	39,200	46,300
~120	20,300	24,500	30,800	34,100	43,800	51,300
~140	22,300	26,800	33,800	37,500	48,000	56,900
~160	24,100	28,600	36,400	40,500	51,800	62,000
~180		31,000	39,400	43,800	56,100	67,500
~200			42,200	46,900	60,300	73,100

ウェーブ数	2W	3W	4W	5W	6W	7W	
H \ W	60~100	~130	~160	~190	~240	~290	~330
80~100	13,500	18,300	21,700	27,400	30,500	39,200	46,300
~120	15,000	20,300	24,500	30,800	34,100	43,800	51,300
~140	16,300	22,300	26,800	33,800	37,500	48,000	56,900
~160		24,100	28,600	36,400	40,500	51,800	62,000
~180			31,000	39,400	43,800	56,100	67,500
~200				42,200	46,900	60,300	73,100

H \ W	60~100	~130	~160	~190	~240	~290	~330
80~100	13,100	17,800	21,200	26,700	29,700	38,200	45,100
~120	14,600	19,700	23,900	30,100	33,400	42,800	50,100
~140	15,900	21,800	26,300	33,100	36,700	47,000	55,600
~160		23,600	28,000	35,700	39,700	50,800	60,800
~180			30,400	38,700	43,000	55,100	66,300
~200				41,500	46,200	59,300	71,900

ウェーブ数	3W	4W	5W	6W	7W	
H \ W	100~130	~160	~190	~240	~290	~330
80~100	20,400	23,900	30,400	33,400	43,100	50,900
~120	22,400	26,700	33,800	37,100	47,700	55,900
~140	24,400	29,000	36,700	40,400	51,900	61,500
~160	26,200	30,800	39,400	43,400	55,600	66,600
~180		33,200	42,400	46,700	59,900	72,200
~200			45,200	49,900	64,100	77,700

ウェーブ数	2W	3W	4W	5W	6W	7W	
H \ W	60~100	~130	~160	~190	~240	~290	~330
80~100	14,900	20,400	23,900	30,400	33,400	43,100	50,900
~120	16,300	22,400	26,700	33,800	37,100	47,700	55,900
~140	17,700	24,400	29,000	36,700	40,400	51,900	61,500
~160		26,200	30,800	39,400	43,400	55,600	66,600
~180			33,200	42,400	46,700	59,900	72,200
~200				45,200	49,900	64,100	77,700

H \ W	60~100	~130	~160	~190	~240	~290	~330
80~100	14,200	19,500	23,000	29,100	32,100	41,400	48,800
~120	15,700	21,500	25,700	32,500	35,800	46,000	53,900
~140	17,100	23,500	28,100	35,500	39,100	50,200	59,400
~160		25,300	29,800	38,100	42,100	53,900	64,600
~180			32,200	41,100	45,400	58,200	70,100
~200				43,900	48,600	62,400	75,700

style no.50 バルーンプレーン													
	コード式					ドラム式							
スワッグ数	1S	2S	3S	4S	5S	1S	2S	3S	4S	5S	6S	7S	8S
H	36~50	~100	~150	~200	~250	40~50	~100	~150	~200	~250	~300	~350	~400
100~140	20,600	32,200	44,600	57,100	71,100	23,600	35,200	47,600	60,100	74,100	85,100	99,300	113,600
~180	23,000	35,800	49,600	63,400	79,000	26,000	38,800	52,600	66,400	82,000	93,900	109,800	125,600
~220	26,000	40,300	55,800	71,300	89,000	29,000	43,300	58,800	74,300	92,000	104,900	122,900	140,700
~260	28,000	44,800	62,000	79,300	99,100	31,000	47,800	65,000	82,300	102,100	115,900	135,800	151,800
~300	31,700	49,200	68,200	87,200	109,100	34,700	52,200	71,200	90,200	112,100	126,800	148,700	170,600

※ 出窓の場合はコーナー1ヶ所につきコード式は3,500円、ドラム式は4,500円プラスになります。

style no.51 バルーンフリル													
	コード式					ドラム式							
スワッグ数	1S	2S	3S	4S	5S	1S	2S	3S	4S	5S	6S	7S	8S
H	36~50	~100	~150	~200	~250	40~50	~100	~150	~200	~250	~300	~350	~400
100~140	21,700	34,700	48,200	61,900	77,100	24,700	37,700	51,200	64,900	80,100	92,200	107,600	123,000
~180	24,100	38,300	53,200	68,200	85,000	27,100	41,300	56,200	71,200	88,000	101,100	118,000	135,000
~220	27,100	42,800	59,400	76,100	95,000	30,100	45,800	62,400	79,100	98,000	112,000	131,100	150,100
~260	29,200	47,300	65,600	84,100	105,000	32,200	50,300	68,600	87,100	108,000	123,000	144,100	161,200
~300	32,800	51,700	71,800	92,000	115,000	35,800	54,700	74,800	95,000	118,000	133,900	157,000	180,000

※ 出窓の場合はコーナー1ヶ所につきコード式は3,500円、ドラム式は4,500円プラスになります。

TM-54389

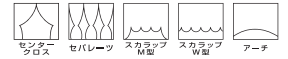
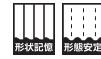

巾 ◇ 100cm 価格 ◇ 1,650円/m
 組成 ◇ ポリエステル100%

リポート ◇ タテ 13.1cm ヨコ 9.8cm
 寸法変化率 ◇ 水洗い/タテ 0.0% ヨコ -0.2%
 ドライ/タテ -0.3% ヨコ -0.3%

取扱表示 ◇ リ-30 40 炎 100 100 F W
 防炎性能 ◇ (イ) あて布使用
 Made in Japan

H \ W	~44 1巾(片開き)	~100 2巾	~150 3巾	~200 4巾	~250 5巾	~300 6巾	~350 7巾	~400 8巾
~100	4,300	8,300	12,600	16,600	20,600	24,800	28,800	33,100
~120	4,900	9,700	14,600	19,700	24,600	29,400	34,200	39,100
~140	5,500	10,600	15,700	21,100	26,300	31,400	36,800	41,900
~160	6,000	12,000	18,000	24,000	30,000	36,000	41,900	47,900
~180	6,600	12,900	19,100	25,400	32,000	38,200	44,500	51,100
~200	7,200	14,300	21,400	28,500	35,700	42,800	49,900	57,000
~220	7,700	15,200	22,600	30,000	37,400	45,100	52,500	59,900
~240	8,300	16,600	24,800	33,100	41,400	49,400	57,600	65,900
~260	8,900	17,400	26,000	34,500	43,100	51,600	60,200	68,700
~280	9,500	18,900	28,300	37,400	46,800	56,200	65,600	74,700
約1.5倍ヒダ	~56	~120	~200	~266	~333	~400	~466	~533
フラット約1倍ヒダ	~80	~160	~260	~360	~460	~560		

H \ W	~44 1巾(片開き)	~100 2巾	~150 3巾	~200 4巾	~250 5巾	~300 6巾	~350 7巾	~400 8巾
~100	4,600	8,900	13,500	17,700	22,000	26,600	30,900	35,400
~120	5,200	10,400	15,600	21,100	26,300	31,500	36,600	41,800
~140	5,800	11,300	16,800	22,600	28,100	33,600	39,400	44,900
~160	6,500	12,900	19,300	25,700	32,100	38,500	44,900	51,300
~180	7,100	13,800	20,500	27,200	34,200	40,900	47,600	54,600
~200	7,700	15,300	22,900	30,500	38,200	45,800	53,400	61,000
~220	8,300	16,200	24,100	32,100	40,000	48,200	56,200	64,100
~240	8,900	17,700	26,600	35,400	44,300	52,800	61,700	70,500
~260	9,500	18,700	27,800	37,000	46,100	55,300	64,400	73,600
~280	10,100	20,200	30,200	40,000	50,100	60,100	70,200	80,000
約1.5倍ヒダ	~56	~120	~200	~266	~333	~400	~466	~533

※片開きはW270cmまで

H \ W	~44 1巾(片開き)	~100 2巾	~150 3巾	~200 4巾	~250 5巾	~300 6巾	~350 7巾	~400 8巾
~100	4,900	9,500	14,300	18,900	23,400	28,300	32,900	37,700
~120	5,600	11,100	16,600	22,500	28,000	33,500	39,000	44,600
~140	6,200	12,100	17,900	24,100	29,900	35,800	42,000	47,800
~160	6,900	13,700	20,500	27,300	34,200	41,000	47,800	54,600
~180	7,500	14,700	21,800	29,000	36,400	43,600	50,700	58,200
~200	8,200	16,300	24,400	32,500	40,700	48,800	56,900	65,000
~220	8,800	17,300	25,700	34,200	42,600	51,400	59,800	68,300
~240	9,500	18,900	28,300	37,700	47,200	56,300	65,700	75,100
~260	10,100	19,900	29,600	39,400	49,100	58,900	68,600	78,400
~280	10,800	21,500	32,200	42,600	53,300	64,100	74,800	85,200
約1.5倍ヒダ	~56	~120	~200	~266	~333	~400	~466	~533

※片開きはW270cmまで

H \ W	~44 1巾(片開き)	~100 2巾	~150 3巾	~200 4巾	~250 5巾	~300 6巾	~350 7巾	~400 8巾
~100	5,500	10,600	16,100	21,200	26,300	31,800	36,900	42,400
~120	6,300	12,500	18,700	25,200	31,400	37,600	43,800	50,100
~140	7,000	13,600	20,100	27,100	33,600	40,200	47,100	53,700
~160	7,700	15,400	23,000	30,700	38,400	46,000	53,700	61,400
~180	8,400	16,500	24,500	32,500	40,900	49,000	57,000	65,400
~200	9,200	18,300	27,400	36,500	45,700	54,800	63,900	73,000
~220	9,900	19,400	28,900	38,400	47,900	57,700	67,200	76,700
~240	10,600	21,200	31,800	42,400	53,000	63,200	73,800	84,400
~260	11,400	22,300	33,300	44,200	55,200	66,100	77,100	88,000

※片開きはW300cmまで

センタークロス

H \ W	~80	~120	~160	~200	~240	~280	~320
~100	10,600	13,900					
~120	11,600	15,500	20,800				
~140	12,900	17,700	23,600	29,300			
~160	13,600	19,000	25,900	32,000	37,100		
~180	15,200	21,200	28,500	35,400	41,100	49,800	
~200	16,400	22,800	30,600	37,400	45,100	53,400	61,300
~220	17,900	24,800	33,600	40,900	48,100	58,200	65,800
~240	19,000	26,500	35,500	43,500	51,100	61,900	70,000
~260	20,500	29,900	38,300	46,800	55,000	66,800	74,000

セパレーツ

H \ W	~40(1P)	~50(1P)	~60(1P)
~100	11,700	14,900	16,100
~120	13,000	16,500	17,700
~140	14,600	18,400	19,700
~160	15,900	19,900	21,200
~180	17,500	22,000	23,200
~200	19,000	23,600	24,800
~220	20,300	25,300	26,600
~240	21,600	26,700	27,800
~260	23,200	28,500	29,400

レースフレンジ style no.12 (タッセル含む)

H \ W	~80	~120	~160	~200	~240	~280	~320
~100	13,500	17,800					
~120	14,700	19,600	26,200				
~140	16,100	22,000	29,100	35,900			
~160	17,100	23,600	31,600	38,800	44,900		
~180	18,900	25,900	34,500	42,400	49,100	59,200	
~200	20,200	27,700	36,700	44,600	53,300	63,000	72,000
~220	22,000	30,000	39,900	48,300	56,500	68,000	76,900
~240	23,300	31,800	42,200	51,100	59,700	72,000	81,200
~260	25,000	35,400	45,100	54,700	63,900	77,000	85,400

レース



スカラップM型

共生地フリル style no.17

ウエーブ数	3W	4W	5W	6W	7W	
H	100~130	~160	~190	~240	~290	~330
80~100	18,000	21,400	25,900	31,600	42,100	48,100
~120	19,300	23,400	28,500	34,600	45,900	51,900
~140	21,300	25,800	31,500	38,300	50,800	58,100
~160	22,800	27,200	33,300	40,600	53,900	62,300
~180		29,500	36,300	44,200	58,800	68,400
~200			38,300	46,900	62,200	73,000

レースフレンジ style no.18

ウエーブ数	3W	4W	5W	6W	7W	
H	100~130	~160	~190	~240	~290	~330
80~100	19,700	23,200	28,200	34,400	45,900	52,400
~120	21,000	25,200	30,800	37,300	49,700	56,200
~140	23,000	27,600	33,800	41,000	54,600	62,400
~160	24,500	29,000	35,600	43,400	57,700	66,600
~180		31,300	38,600	46,900	62,600	72,700
~200			40,600	49,600	66,000	77,300

スカラップW型

共生地フリル style no.19

ウエーブ数	2W	3W	4W	5W	6W	7W	
H	60~100	~130	~160	~190	~240	~290	~330
80~100	14,100	18,000	21,400	25,900	31,600	42,100	48,100
~120	15,100	19,300	23,400	28,500	34,600	45,900	51,900
~140	16,800	21,300	25,800	31,500	38,300	50,800	58,100
~160		22,800	27,200	33,300	40,600	53,900	62,300
~180			29,500	36,300	44,200	58,800	68,400
~200				38,300	46,900	62,200	73,000

レースフレンジ style no.20

ウエーブ数	2W	3W	4W	5W	6W	7W	
H	60~100	~130	~160	~190	~240	~290	~330
80~100	15,400	19,700	23,200	28,200	34,400	45,900	52,400
~120	16,400	21,000	25,200	30,800	37,300	49,700	56,200
~140	18,100	23,000	27,600	33,800	41,000	54,600	62,400
~160		24,500	29,000	35,600	43,400	57,700	66,600
~180			31,300	38,600	46,900	62,600	72,700
~200				40,600	49,600	66,000	77,300

アーチ

共生地フリル style no.26

ウエーブ数	60~100	~130	~160	~190	~240	~290	~330
80~100	13,700	17,500	20,800	25,300	30,800	41,000	46,900
~120	14,800	18,800	22,900	27,800	33,800	44,800	50,600
~140	16,400	20,800	25,200	30,800	37,500	49,700	56,800
~160		22,300	26,600	32,600	39,800	52,800	61,000
~180			29,000	35,600	43,400	57,700	67,100
~200				37,700	46,100	61,100	71,800

レースフレンジ style no.27

ウエーブ数	60~100	~130	~160	~190	~240	~290	~330
80~100	14,700	18,900	22,300	27,100	33,100	44,100	50,400
~120	15,800	20,200	24,400	29,700	36,000	47,900	54,100
~140	17,400	22,200	26,700	32,700	39,800	52,800	60,400
~160		23,700	28,100	34,500	42,100	55,900	64,600
~180			30,400	37,500	45,600	60,800	70,700
~200				39,500	48,300	64,200	75,300

TM-54390

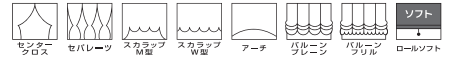

巾 ◇ 100cm 価格 ◇ 1,300円/m
組成 ◇ ポリエステル100%

リポート ◇ タテ 24.6cm ヨコ 24.8cm
寸法変化率 ◇ 水洗い/タテ -0.2% ヨコ -0.2%
ドライ/タテ -1.0% ヨコ -1.0%

取扱い表示 ◇ リ-30
防炎性能 ◇ (イ)
Made in Japan

H \ W	~44 1巾(片開き)	~100 2巾	~150 3巾	~200 4巾	~250 5巾	~300 6巾	~350 7巾	~400 8巾
~100	3,800	7,500	11,300	14,800	18,500	22,300	26,000	29,500
~120	4,500	8,800	13,000	17,300	21,800	26,000	30,300	34,500
~140	5,000	10,000	14,800	19,800	24,800	29,500	34,500	39,500
~160	5,800	11,300	16,800	22,300	27,800	33,300	38,800	44,500
~180	5,800	11,300	16,800	22,300	27,800	33,300	38,800	44,500
~200	6,300	12,500	18,500	24,800	30,800	37,000	43,300	49,300
~220	6,800	13,800	20,500	27,300	34,000	40,800	47,500	54,300
~240	7,500	14,800	22,300	29,500	37,000	44,500	51,800	59,300
~260	8,000	16,000	24,000	32,000	40,000	48,000	56,000	64,000
~280	8,000	16,000	24,000	32,000	40,000	48,000	56,000	64,000
約1.5倍ヒダ	~56	~120	~200	~266	~333	~400	~466	~533
フラット約1倍ヒダ	~80	~160	~260	~360	~460	~560		

H \ W	~44 1巾(片開き)	~100 2巾	~150 3巾	~200 4巾	~250 5巾	~300 6巾	~350 7巾	~400 8巾
~100	4,100	8,100	12,200	16,000	20,000	24,100	28,100	31,900
~120	4,900	9,500	14,100	18,700	23,500	28,100	32,700	37,300
~140	5,400	10,800	16,000	21,400	26,800	31,900	37,300	42,700
~160	6,300	12,200	18,100	24,100	30,000	36,000	41,900	48,100
~180	6,300	12,200	18,100	24,100	30,000	36,000	41,900	48,100
~200	6,800	13,500	20,000	26,800	33,300	40,000	46,800	53,200
~220	7,300	14,900	22,200	29,500	36,800	44,100	51,300	58,600
~240	8,100	16,000	24,100	31,900	40,000	48,100	55,900	64,000
~260	8,700	17,300	26,000	34,600	43,200	51,900	60,500	69,200
~280	8,700	17,300	26,000	34,600	43,200	51,900	60,500	69,200
約1.5倍ヒダ	~56	~120	~200	~266	~333	~400	~466	~533

※片開きはW270cmまで

H \ W	~44 1巾(片開き)	~100 2巾	~150 3巾	~200 4巾	~250 5巾	~300 6巾	~350 7巾	~400 8巾
~100	4,400	8,700	13,100	17,200	21,500	25,900	30,200	34,300
~120	5,300	10,200	15,100	20,100	25,300	30,200	35,100	40,100
~140	5,800	11,600	17,200	23,000	28,800	34,300	40,100	45,900
~160	6,700	13,100	19,500	25,900	32,200	38,600	45,000	51,700
~180	6,700	13,100	19,500	25,900	32,200	38,600	45,000	51,700
~200	7,300	14,500	21,500	28,800	35,700	43,000	50,200	57,200
~220	7,900	16,000	23,800	31,700	39,500	47,300	55,100	63,000
~240	8,700	17,200	25,900	34,300	43,000	51,700	60,100	68,800
~260	9,300	18,600	27,900	37,200	46,400	55,700	65,000	74,300
~280	9,300	18,600	27,900	37,200	46,400	55,700	65,000	74,300
約1.5倍ヒダ	~56	~120	~200	~266	~333	~400	~466	~533

※片開きはW270cmまで

H \ W	~44 1巾(片開き)	~100 2巾	~150 3巾	~200 4巾	~250 5巾	~300 6巾	~350 7巾	~400 8巾
~100	5,000	9,900	14,900	19,500	24,500	29,400	34,400	39,000
~120	6,000	11,600	17,200	22,800	28,800	34,400	40,000	45,600
~140	6,600	13,200	19,500	26,100	32,700	39,000	45,600	52,200
~160	7,600	14,900	22,200	29,400	36,700	43,900	51,200	58,800
~180	7,600	14,900	22,200	29,400	36,700	43,900	51,200	58,800
~200	8,300	16,500	24,500	32,700	40,600	48,900	57,100	65,100
~220	9,000	18,200	27,100	36,000	44,900	53,800	62,700	71,700
~240	9,900	19,500	29,400	39,000	48,900	58,800	68,400	78,300
~260	10,600	21,200	31,700	42,300	52,800	63,400	74,000	84,500

※片開きはW300cmまで

センタークロス (タッセル含む)

H \ W	~80	~120	~160	~200	~240	~280	~320
~100	9,600	12,500					
~120	10,700	14,300	19,200				
~140	11,300	15,400	20,600	25,700			
~160	12,200	17,100	23,100	28,700	33,300		
~180	13,500	18,900	25,400	31,600	36,700	44,500	
~200	14,900	20,700	27,800	34,000	41,100	48,600	55,900
~220	16,100	22,400	30,300	37,000	43,500	52,800	59,600
~240	17,400	24,300	32,600	40,000	47,000	57,000	64,400
~260	18,200	26,600	34,000	41,500	48,900	59,300	65,600

セバレーツ (タッセル含む)

H \ W	~40(1P)	~50(1P)	~60(1P)
~100	10,900	13,800	15,000
~120	12,400	15,600	16,700
~140	13,500	16,700	17,900
~160	14,800	18,300	19,600
~180	16,300	20,100	21,300
~200	17,800	21,800	23,000
~220	18,900	23,200	24,500
~240	20,400	24,800	25,900
~260	21,600	25,800	26,600

レースフレンジ style no.12 (タッセル含む)

H \ W	~80	~120	~160	~200	~240	~280	~320
~100	12,900	16,900					
~120	14,300	19,000	25,200				
~140	15,000	20,300	26,900	33,100			
~160	16,300	22,300	29,600	36,400	42,000		
~180	17,800	24,300	32,300	39,500	45,700	55,100	
~200	19,400	26,400	34,800	42,200	50,500	59,500	68,000
~220	20,900	28,300	37,600	45,400	53,100	64,000	72,100
~240	22,400	30,400	40,200	48,600	56,800	68,400	77,100
~260	23,500	33,000	41,900	50,500	59,000	70,900	78,500

スカラップM型

ウェーブ数	3W	4W	5W	6W	7W	
H \ W	100-130	~160	~190	~240	~290	~330
80-100	16,000	19,300	23,500	28,600	37,900	43,300
~120	17,600	21,700	26,400	32,100	42,300	47,900
~140	18,400	22,700	27,600	33,700	44,300	50,800
~160	20,100	24,300	29,900	36,500	48,100	55,800
~180	26,400	32,400	39,500	52,300	61,200	
~200		34,900	42,700	56,500	66,500	

スカラップW型

ウェーブ数	2W	3W	4W	5W	6W	7W	
H \ W	60-100	~130	~160	~190	~240	~290	~330
80-100	12,600	16,000	19,300	23,500	28,600	37,900	43,300
~120	13,900	17,600	21,700	26,400	32,100	42,300	47,900
~140	14,500	18,400	22,700	27,600	33,700	44,300	50,800
~160	20,100	24,300	29,900	36,500	48,100	55,800	
~180	26,400	32,400	39,500	52,300	61,200		
~200		34,900	42,700	56,500	66,500		

アーチ

H \ W	60-100	~130	~160	~190	~240	~290	~330
80-100	12,300	15,600	18,900	22,900	28,000	37,000	42,300
~120	13,600	17,200	21,300	25,800	31,400	41,400	46,900
~140	14,200	18,000	22,300	27,100	33,100	43,500	49,800
~160	19,700	23,900	29,400	35,900	47,200	54,800	
~180	26,000	31,900	38,900	51,400	60,200		
~200		34,400	42,100	55,600	65,500		

レースフレンジ style no.18

ウェーブ数	3W	4W	5W	6W	7W	
H \ W	100-130	~160	~190	~240	~290	~330
80-100	18,600	22,000	26,900	32,700	43,600	49,700
~120	20,200	24,400	29,800	36,100	48,000	54,300
~140	20,900	25,400	31,000	37,800	50,000	57,200
~160	22,700	27,000	33,300	40,600	53,800	62,200
~180	29,100	35,800	43,600	58,000	67,600	
~200		38,300	46,800	62,200	73,000	

レースフレンジ style no.20

ウェーブ数	2W	3W	4W	5W	6W	7W	
H \ W	60-100	~130	~160	~190	~240	~290	~330
80-100	14,500	18,600	22,000	26,900	32,700	43,600	49,700
~120	15,900	20,200	24,400	29,800	36,100	48,000	54,300
~140	16,500	20,900	25,400	31,000	37,800	50,000	57,200
~160	22,700	27,000	33,300	40,600	53,800	62,200	
~180	29,100	35,800	43,600	58,000	67,600		
~200		38,300	46,800	62,200	73,000		

レースフレンジ style no.27

H \ W	60-100	~130	~160	~190	~240	~290	~330
80-100	13,900	17,800	21,200	25,800	31,400	41,800	47,700
~120	15,200	19,400	23,500	28,700	34,800	46,200	52,300
~140	15,900	20,100	24,500	29,900	36,500	48,200	55,200
~160	21,800	26,200	32,200	39,300	52,000	60,100	
~180	28,200	34,					

style no.50 バルーンプレーン													
	コード式					ドラム式							
スワッグ数	1S	2S	3S	4S	5S	1S	2S	3S	4S	5S	6S	7S	8S
H	36~50	~100	~150	~200	~250	40~50	~100	~150	~200	~250	~300	~350	~400
100~140	20,700	30,700	41,600	52,500	66,800	23,700	33,700	44,600	55,500	69,800	82,500	95,100	107,800
~180	23,800	35,100	47,300	59,600	76,100	26,800	38,100	50,300	62,600	79,100	93,500	107,700	122,000
~220	26,400	38,600	52,100	65,400	83,800	29,400	41,600	55,100	68,400	86,800	102,200	117,900	133,600
~260	28,600	43,000	57,700	72,600	93,100	31,600	46,000	60,700	75,600	96,100	113,100	130,400	143,900
~300	32,000	46,500	62,500	78,500	100,700	35,000	49,500	65,500	81,500	103,700	121,800	140,700	159,500

※出窓の場合はコーナー1ヶ所につきコード式は3,500円、ドラム式は4,500円プラスになります。

style no.51 バルーンフリル													
	コード式					ドラム式							
スワッグ数	1S	2S	3S	4S	5S	1S	2S	3S	4S	5S	6S	7S	8S
H	36~50	~100	~150	~200	~250	40~50	~100	~150	~200	~250	~300	~350	~400
100~140	21,800	32,700	44,500	56,300	71,600	24,800	35,700	47,500	59,300	74,600	88,200	101,700	115,300
~180	24,900	37,100	50,200	63,400	80,900	27,900	40,100	53,200	66,400	83,900	99,200	114,400	129,600
~220	27,400	40,600	55,000	69,300	88,600	30,400	43,600	58,000	72,300	91,600	107,900	124,600	141,200
~260	29,600	44,900	60,600	76,500	97,900	32,600	47,900	63,600	79,500	100,900	118,800	137,100	151,500
~300	33,000	48,500	65,400	82,300	105,500	36,000	51,500	68,400	85,300	108,500	127,500	147,300	167,100

※出窓の場合はコーナー1ヶ所につきコード式は3,500円、ドラム式は4,500円プラスになります。

style no.S01 ロールソフト			
スプリング・チェーンタイプ			
スワッグ数	30~60	~80	~90
H	30~60	~80	~90
50~80	27,200	29,700	31,700
~120	28,800	31,900	33,900
~160	30,400	34,200	36,200
~200	32,800	35,800	38,000
~240		38,000	40,300

※丈は巾の3倍までが限度です。

※ロールソフト加工品は非防炎品になります。

TM-54391



巾 ◇ 100cm 価格 ◇ 1,400円/m
組成 ◇ ポリエステル100%

リポート ◇ タテ cm ヨコ 6.2 cm
寸法変化率 ◇ 水洗い/タテ -0.7% ヨコ -1.0%
ドライ/タテ 0.0% ヨコ -0.9%

取り扱い表示 ◇ リ-30
防炎性能 ◇ (イ)
Made in Japan

H \ W	~44 1巾(片開き)	~100 2巾	~150 3巾	~200 4巾	~250 5巾	~300 6巾	~350 7巾	~400 8巾
~100	3,700	7,300	11,000	14,600	18,200	21,900	25,500	29,200
~120	4,200	8,400	12,500	16,700	20,800	25,000	29,200	33,300
~140	4,700	9,400	14,100	18,800	23,400	28,100	32,800	37,500
~160	5,200	10,400	15,600	20,800	26,000	31,200	36,400	41,600
~180	5,800	11,500	17,200	22,900	28,600	34,400	40,100	45,800
~200	6,300	12,500	18,800	25,000	31,200	37,500	43,700	50,000
~220	6,800	13,600	20,300	27,100	33,800	40,600	47,400	54,100
~240	7,300	14,600	21,900	29,200	36,400	43,700	51,000	58,300
~260	7,800	15,600	23,400	31,200	39,000	46,800	54,600	62,400
~280	8,400	16,700	25,000	33,300	41,600	50,000	58,300	66,600
約1.5倍ヒダ	~56	~120	~200	~266	~333	~400	~466	~533
フラット約1倍ヒダ	~80	~160	~260	~360	~460	~560		

H \ W	~44 1巾(片開き)	~100 2巾	~150 3巾	~200 4巾	~250 5巾	~300 6巾	~350 7巾	~400 8巾
~100	4,000	7,900	11,800	15,700	19,600	23,600	27,500	31,400
~120	4,500	9,000	13,500	18,000	22,400	26,900	31,400	35,900
~140	5,100	10,100	15,200	20,200	25,200	30,300	35,300	40,400
~160	5,600	11,200	16,800	22,400	28,000	33,600	39,200	44,800
~180	6,200	12,400	18,500	24,700	30,800	37,000	43,200	49,300
~200	6,800	13,500	20,200	26,900	33,600	40,400	47,100	53,800
~220	7,300	14,600	21,900	29,200	36,400	43,700	51,000	58,300
~240	7,900	15,700	23,600	31,400	39,200	47,100	54,900	62,800
~260	8,400	16,800	25,200	33,600	42,000	50,400	58,800	67,200
~280	9,000	18,000	26,900	35,900	44,800	53,800	62,800	71,700
約1.5倍ヒダ	~56	~120	~200	~266	~333	~400	~466	~533

※片開きはW270cmまで

H \ W	~44 1巾(片開き)	~100 2巾	~150 3巾	~200 4巾	~250 5巾	~300 6巾	~350 7巾	~400 8巾
~100	4,200	8,400	12,600	16,800	21,000	25,200	29,400	33,600
~120	4,800	9,600	14,400	19,200	24,000	28,800	33,600	38,400
~140	5,400	10,800	16,200	21,600	27,000	32,400	37,800	43,200
~160	6,000	12,000	18,000	24,000	30,000	36,000	42,000	48,000
~180	6,600	13,200	19,800	26,400	33,000	39,600	46,200	52,800
~200	7,200	14,400	21,600	28,800	36,000	43,200	50,400	57,600
~220	7,800	15,600	23,400	31,200	39,000	46,800	54,600	62,400
~240	8,400	16,800	25,200	33,600	42,000	50,400	58,800	67,200
~260	9,000	18,000	27,000	36,000	45,000	54,000	63,000	72,000
~280	9,600	19,200	28,800	38,400	48,000	57,600	67,200	76,800
約1.5倍ヒダ	~56	~120	~200	~266	~333	~400	~466	~533

※片開きはW270cmまで

H \ W	~44 1巾(片開き)	~100 2巾	~150 3巾	~200 4巾	~250 5巾	~300 6巾	~350 7巾	~400 8巾
~100	4,800	9,600	14,300	19,100	23,800	28,600	33,400	38,100
~120	5,500	10,900	16,400	21,800	27,200	32,700	38,100	43,600
~140	6,200	12,300	18,400	24,500	30,600	36,800	42,900	49,000
~160	6,800	13,600	20,400	27,200	34,000	40,800	47,600	54,400
~180	7,500	15,000	22,500	30,000	37,400	44,900	52,400	59,900
~200	8,200	16,400	24,500	32,700	40,800	49,000	57,200	65,300
~220	8,900	17,700	26,600	35,400	44,200	53,100	61,900	70,800
~240	9,600	19,100	28,600	38,100	47,600	57,200	66,700	76,200
~260	10,200	20,400	30,600	40,800	51,000	61,200	71,400	81,600

※片開きはW300cmまで

センタークロス (タッセル含む)

H \ W	~80	~120	~160	~200	~240	~280	~320
~100	9,600	12,500					
~120	10,600	14,200	19,100				
~140	11,700	15,900	21,400	26,600			
~160	12,500	17,500	23,800	29,400	34,200		
~180	13,800	19,300	26,000	32,300	37,500	45,400	
~200	15,100	21,000	28,200	34,500	41,700	49,400	56,700
~220	16,200	22,600	30,600	37,400	44,000	53,200	60,200
~240	17,500	24,400	32,800	40,100	47,200	57,200	64,700
~260	18,800	27,400	35,100	42,800	50,400	61,200	67,700

セパレート (タッセル含む)

H \ W	~40(1P)	~50(1P)	~60(1P)
~100	11,000	13,800	15,000
~120	12,400	15,500	16,700
~140	13,800	17,100	18,400
~160	15,100	18,700	19,900
~180	16,500	20,400	21,600
~200	18,100	22,100	23,300
~220	19,100	23,600	24,800
~240	20,500	25,000	26,100
~260	22,000	26,500	27,400

レースフレンジ style no.12 (タッセル含む)

H \ W	~80	~120	~160	~200	~240	~280	~320
~100	12,800	16,800					
~120	14,100	18,700	24,900				
~140	15,300	20,700	27,500	33,800			
~160	16,500	22,600	30,100	36,900	42,700		
~180	17,900	24,600	32,600	39,900	46,200	55,700	
~200	19,400	26,500	35,000	42,500	50,800	59,800	68,400
~220	20,800	28,400	37,600	45,500	53,200	64,000	72,200
~240	22,300	30,300	40,100	48,500	56,700	68,200	76,900
~260	23,800	33,500	42,600	51,500	60,200	72,400	80,200

スカラップM型

ウェーブ数	3W	4W	5W	6W	7W	
H \ W	100-130	~160	~190	~240	~290	~330
80-100	16,000	19,300	23,500	28,700	37,900	43,400
~120	17,600	21,600	26,300	31,900	42,200	47,700
~140	19,200	23,500	28,700	34,900	46,100	52,800
~160	20,700	25,000	30,700	37,500	49,500	57,400
~180	22,900	28,100	33,100	40,400	53,400	62,500
~200		35,400	43,400	57,300	67,500	

スカラップW型

ウェーブ数	2W	3W	4W	5W	6W	7W	
H \ W	60-100	~130	~160	~190	~240	~290	~330
80-100	12,600	16,000	19,300	23,500	28,700	37,900	43,400
~120	13,800	17,600	21,600	26,300	31,900	42,200	47,700
~140	15,100	19,200	23,500	28,700	34,900	46,100	52,800
~160	16,500	20,700	25,000	30,700	37,500	49,500	57,400
~180	18,100	22,900	28,100	33,100	40,400	53,400	62,500
~200		35,400	43,400	57,300	67,500		

アーチ

H \ W	60-100	~130	~160	~190	~240	~290	~330
80-100	12,300	15,600	18,900	22,900	28,000	37,000	42,300
~120	13,500	17,100	21,200	25,700	31,300	41,300	46,700
~140	14,700	18,700	23,100	28,100	34,200	45,100	51,700
~160	16,000	20,300	24,600	30,100	36,800	48,600	56,400
~180	17,500	22,600	26,500	32,500	39,800	52,500	61,400
~200		34,900	42,700	56,400	66,500		

レースフレンジ style no.18

ウェーブ数	3W	4W	5W	6W	7W	
H \ W	100-130	~160	~190	~240	~290	~330
80-100	18,400	21,800	26,600	32,400	43,100	49,200
~120	19,900	24,100	29,400	35,600	47,400	53,600
~140	21,500	26,000	31,700	38,600	51,300	58,600
~160	23,100	27,500	33,800	41,200	54,700	63,200
~180	24,900	30,100	36,100	44,100	58,600	68,300
~200		38,500	47,100	62,500	73,300	

レースフレンジ style no.20

ウェーブ数	2W	3W	4W	5W	6W	7W	
H \ W	60-100	~130	~160	~190	~240	~290	~330
80-100	14,300	18,400	21,800	26,600	32,400	43,100	49,200
~120	15,600	19,900	24,100	29,400	35,600	47,400	53,600
~140	16,800	21,500	26,000	31,700	38,600	51,300	58,600
~160	18,100	23,100	27,500	33,800	41,200	54,700	63,200
~180	19,500	24,900	30,100	36,100	44,100	58,600	68,300
~200		38,500	47,100	62,500	73,300		

レースフレンジ style no.27

H \ W	60-100	~130	~160	~190	~240	~290	~330
80-100	13,700	17,500	20,900	25,500	31,100	41,300	47,200
~120	15,000	19,100	23,200	28,300	34,300	45,600	51,500
~140	16,200	20,700	25,100	30,700	37,300	49,400	56,600
~160	17,500	22,600	26,600	32,700	39,900</		

style no.60 プレーンシェード														
		コード式					ドラム式							
H	W	30~45	~90	~140	~190	~240	30~45	~90	~140	~190	~240	~290	~340	~390
50~100		11,500	15,600	21,600	25,700	31,800	14,500	18,600	24,600	28,700	34,800	42,000	48,200	53,000
	~140	12,900	17,100	23,700	27,900	34,700	15,900	20,100	26,700	30,900	37,700	45,100	52,000	56,900
	~180	14,200	18,400	25,900	30,100	37,600	17,200	21,400	28,900	33,100	40,600	48,100	55,500	60,500
	~220	15,600	19,900	28,000	32,300	40,400	18,600	22,900	31,000	35,300	43,400	51,200	59,200	64,300
	~260	16,900	21,300	30,100	34,400	43,300	19,900	24,300	33,100	37,400	46,300	54,100	63,000	68,000
	~300	18,200	22,700	32,200	36,600	46,200	21,200	25,700	35,200	39,600	49,200	57,300	66,500	71,800

※ドラム式：仕上り巾39cm以下の場合、仕上り丈は200cmまでとなります。

スリムシェード		コード式
H	W	18~30
50~100		16,400
	~140	18,300
	~180	19,800
	~220	21,700
	~240	23,000

style no.50 バルーンブレース														
		コード式					ドラム式							
スワッグ数		1S	2S	3S	4S	5S	1S	2S	3S	4S	5S	6S	7S	8S
H	W	36~50	~100	~150	~200	~250	40~50	~100	~150	~200	~250	~300	~350	~400
100~140		20,700	30,700	41,500	52,400	66,800	23,700	33,700	44,500	55,400	69,800	82,500	95,100	107,700
	~180	23,600	34,800	47,000	59,200	75,700	26,600	37,800	50,000	62,200	78,700	92,900	107,100	121,300
	~220	26,600	39,000	52,500	66,100	84,600	29,600	42,000	55,500	69,100	87,600	103,200	119,000	134,900
	~260	28,700	43,100	58,000	72,900	93,600	31,700	46,100	61,000	75,900	96,600	113,500	131,000	144,500
	~300	32,500	47,300	63,500	79,700	102,500	35,500	50,300	66,500	82,700	105,500	123,800	143,000	162,100

※出窓の場合はコーナー1ヶ所につきコード式は3,500円、ドラム式は4,500円プラスになります。

style no.51 バルーンフリル														
		コード式					ドラム式							
スワッグ数		1S	2S	3S	4S	5S	1S	2S	3S	4S	5S	6S	7S	8S
H	W	36~50	~100	~150	~200	~250	40~50	~100	~150	~200	~250	~300	~350	~400
100~140		21,800	32,800	44,700	56,500	71,900	24,800	35,800	47,700	59,500	74,900	88,700	102,300	115,900
	~180	24,700	37,000	50,200	63,400	80,800	27,700	40,000	53,200	66,400	83,800	99,000	114,200	129,500
	~220	27,700	41,100	55,700	70,200	89,800	30,700	44,100	58,700	73,200	92,800	109,300	126,200	143,100
	~260	29,900	45,200	61,100	77,000	98,700	32,900	48,200	64,100	80,000	101,700	119,700	138,200	152,700
	~300	33,600	49,400	66,700	83,900	107,600	36,600	52,400	69,700	86,900	110,600	130,000	150,100	170,200

※出窓の場合はコーナー1ヶ所につきコード式は3,500円、ドラム式は4,500円プラスになります。

style no.S01 ロールソフト			
スプリング・チェーンタイプ			
H	W	30~60	~80
		~90	
50~80		27,200	29,700
	~120	28,700	31,800
	~160	30,300	34,100
	~200	32,900	35,900
	~240	38,000	40,300

※丈は巾の3倍までが限度です。

※ロールソフト加工品は非防災品になります。

TM-54392



巾 ◇ 100cm 価格 ◇ 1,400円/m
組成 ◇ ポリエステル100%

リポート ◇ タテ cm ヨコ 1.6 cm
寸法変化率 ◇ 水洗い/タテ -0.2% ヨコ -0.7%
ドライ/タテ -0.3% ヨコ -0.5%

取扱い表示 ◇ リ-30
防炎性能 ◇ (イ)
Made in Japan

H \ W	~44 1巾(片開き)	~100 2巾	~150 3巾	~200 4巾	~250 5巾	~300 6巾	~350 7巾	~400 8巾
~100	3,700	7,300	11,000	14,600	18,200	21,900	25,500	29,200
~120	4,200	8,400	12,500	16,700	20,800	25,000	29,200	33,300
~140	4,700	9,400	14,100	18,800	23,400	28,100	32,800	37,500
~160	5,200	10,400	15,600	20,800	26,000	31,200	36,400	41,600
~180	5,800	11,500	17,200	22,900	28,600	34,400	40,100	45,800
~200	6,300	12,500	18,800	25,000	31,200	37,500	43,700	50,000
~220	6,800	13,600	20,300	27,100	33,800	40,600	47,400	54,100
~240	7,300	14,600	21,900	29,200	36,400	43,700	51,000	58,300
~260	7,800	15,600	23,400	31,200	39,000	46,800	54,600	62,400
~280	8,400	16,700	25,000	33,300	41,600	50,000	58,300	66,600
約1.5倍ヒダ	~56	~120	~200	~266	~333	~400	~466	~533
フラット前1倍ヒダ	~80	~160	~260	~360	~460	~560		

H \ W	~44 1巾(片開き)	~100 2巾	~150 3巾	~200 4巾	~250 5巾	~300 6巾	~350 7巾	~400 8巾
~100	4,000	7,900	11,800	15,700	19,600	23,600	27,500	31,400
~120	4,500	9,000	13,500	18,000	22,400	26,900	31,400	35,900
~140	5,100	10,100	15,200	20,200	25,200	30,300	35,300	40,400
~160	5,600	11,200	16,800	22,400	28,000	33,600	39,200	44,800
~180	6,200	12,400	18,500	24,700	30,800	37,000	43,200	49,300
~200	6,800	13,500	20,200	26,900	33,600	40,400	47,100	53,800
~220	7,300	14,600	21,900	29,200	36,400	43,700	51,000	58,300
~240	7,900	15,700	23,600	31,400	39,200	47,100	54,900	62,800
~260	8,400	16,800	25,200	33,600	42,000	50,400	58,800	67,200
~280	9,000	18,000	26,900	35,900	44,800	53,800	62,800	71,700
約1.5倍ヒダ	~56	~120	~200	~266	~333	~400	~466	~533

H \ W	~44 1巾(片開き)	~100 2巾	~150 3巾	~200 4巾	~250 5巾	~300 6巾	~350 7巾	~400 8巾
~100	4,200	8,400	12,600	16,800	21,000	25,200	29,400	33,600
~120	4,800	9,600	14,400	19,200	24,000	28,800	33,600	38,400
~140	5,400	10,800	16,200	21,600	27,000	32,400	37,800	43,200
~160	6,000	12,000	18,000	24,000	30,000	36,000	42,000	48,000
~180	6,600	13,200	19,800	26,400	33,000	39,600	46,200	52,800
~200	7,200	14,400	21,600	28,800	36,000	43,200	50,400	57,600
~220	7,800	15,600	23,400	31,200	39,000	46,800	54,600	62,400
~240	8,400	16,800	25,200	33,600	42,000	50,400	58,800	67,200
~260	9,000	18,000	27,000	36,000	45,000	54,000	63,000	72,000
~280	9,600	19,200	28,800	38,400	48,000	57,600	67,200	76,800
約1.5倍ヒダ	~56	~120	~200	~266	~333	~400	~466	~533

H \ W	~44 1巾(片開き)	~100 2巾	~150 3巾	~200 4巾	~250 5巾	~300 6巾	~350 7巾	~400 8巾
~100	4,800	9,600	14,300	19,100	23,800	28,600	33,400	38,100
~120	5,500	10,900	16,400	21,800	27,200	32,700	38,100	43,600
~140	6,200	12,300	18,400	24,500	30,600	36,800	42,900	49,000
~160	6,800	13,600	20,400	27,200	34,000	40,800	47,600	54,400
~180	7,500	15,000	22,500	30,000	37,400	44,900	52,400	59,900
~200	8,200	16,400	24,500	32,700	40,800	49,000	57,200	65,300
~220	8,900	17,700	26,600	35,400	44,200	53,100	61,900	70,800
~240	9,600	19,100	28,600	38,100	47,600	57,200	66,700	76,200
~260	10,200	20,400	30,600	40,800	51,000	61,200	71,400	81,600

センタークロス

H \ W	~80	~120	~160	~200	~240	~280	~320
~100	9,600	12,500					
~120	10,600	14,200	19,100				
~140	11,700	15,900	21,400	26,600			
~160	12,500	17,500	23,800	29,400	34,200		
~180	13,800	19,300	26,000	32,300	37,500	45,400	
~200	15,100	21,000	28,200	34,500	41,700	49,400	56,700
~220	16,200	22,600	30,600	37,400	44,000	53,200	60,200
~240	17,500	24,400	32,800	40,100	47,200	57,200	64,700
~260	18,800	27,400	35,100	42,800	50,400	61,200	67,700

セパレート

H \ W	~40(1P)	~50(1P)	~60(1P)
~100	11,000	13,800	15,000
~120	12,400	15,500	16,700
~140	13,800	17,100	18,400
~160	15,100	18,700	19,900
~180	16,500	20,400	21,600
~200	18,100	22,100	23,300
~220	19,100	23,600	24,800
~240	20,500	25,000	26,100
~260	22,000	26,500	27,400

レースフレンジ style no.12 (タッセル含む)

H \ W	~80	~120	~160	~200	~240	~280	~320
~100	12,800	16,800					
~120	14,100	18,700	24,900				
~140	15,300	20,700	27,500	33,800			
~160	16,500	22,600	30,100	36,900	42,700		
~180	17,900	24,600	32,600	39,900	46,200	55,700	
~200	19,400	26,500	35,000	42,500	50,800	59,800	68,400
~220	20,800	28,400	37,600	45,500	53,200	64,000	72,200
~240	22,300	30,300	40,100	48,500	56,700	68,200	76,900
~260	23,800	33,500	42,600	51,500	60,200	72,400	80,200

スカラップM型

ウェーブ数	3W	4W	5W	6W	7W	
H \ W	100-130	~160	~190	~240	~290	~330
80-100	16,000	19,300	23,500	28,700	37,900	43,400
~120	17,600	21,600	26,300	31,900	42,200	47,700
~140	19,200	23,500	28,700	34,900	46,100	52,800
~160	20,700	25,000	30,700	37,500	49,500	57,400
~180	22,900	26,900	33,100	40,400	53,400	62,500
~200		35,400	43,400	57,300	67,500	

スカラップW型

ウェーブ数	2W	3W	4W	5W	6W	7W	
H \ W	60-100	~130	~160	~190	~240	~290	~330
80-100	12,600	16,000	19,300	23,500	28,700	37,900	43,400
~120	13,800	17,600	21,600	26,300	31,900	42,200	47,700
~140	15,100	19,200	23,500	28,700	34,900	46,100	52,800
~160	20,700	25,000	30,700	37,500	49,500	57,400	
~180	26,900	33,100	40,400	53,400	62,500		
~200		35,400	43,400	57,300	67,500		

アーチ

H \ W	60-100	~130	~160	~190	~240	~290	~330
80-100	12,300	15,600	18,900	22,900	28,000	37,000	42,300
~120	13,500	17,100	21,200	25,700	31,300	41,300	46,700
~140	14,700	18,700	23,100	28,100	34,200	45,100	51,700
~160	20,300	24,600	30,100	36,800	46,600	56,400	
~180	26,500	32,500	39,800	52,500	61,400		
~200		34,900	42,700	56,400	66,500		

レースフレンジ style no.18

ウェーブ数	3W	4W	5W	6W	7W	
H \ W	100-130	~160	~190	~240	~290	~330
80-100	18,400	21,800	26,600	32,400	43,100	49,200
~120	19,900	24,100	29,400	35,600	47,400	53,600
~140	21,500	26,000	31,700	38,600	51,300	58,600
~160	23,100	27,500	33,800	41,200	54,700	63,200
~180	29,400	36,100	44,100	58,600	68,300	
~200		38,500	47,100	62,500	73,300	

レースフレンジ style no.20

ウェーブ数	2W	3W	4W	5W	6W	7W	
H \ W	60-100	~130	~160	~190	~240	~290	~330
80-100	14,300	18,400	21,800	26,600	32,400	43,100	49,200
~120	15,600	19,900	24,100	29,400	35,600	47,400	53,600
~140	16,800	21,500	26,000	31,700	38,600	51,300	58,600
~160	23,100	27,500	33,800	41,200	54,700	63,200	
~180	29,400	36,100	44,100	58,600	68,300		
~200		38,500	47,100	62,500	73,300		

レースフレンジ style no.27

H \ W	60-100	~130	~160	~190	~240	~290	~330
80-100	13,700	17,500	20,900	25,500	31,100	41,300	47,200
~120	15,000	19,100	23,200	28,300	34,300	45,600	51,500
~140	16,200	20,700	25,100	30,700	37,300	49,400	56,600
~160	22,200	26,600	32,700	39,900	52,900	61,200	
~180	28,500	35,100	42,800	56,800	66,200		
~200		37,400	45,800	60,700	71,300		

style no.50 バルーンプレーン													
	コード式					ドラム式							
スワッグ数	1S	2S	3S	4S	5S	1S	2S	3S	4S	5S	6S	7S	8S
H	36~50	~100	~150	~200	~250	40~50	~100	~150	~200	~250	~300	~350	~400
100~140	20,700	30,700	41,500	52,400	66,800	23,700	33,700	44,500	55,400	69,800	82,500	95,100	107,700
~180	23,600	34,800	47,000	59,200	75,700	26,600	37,800	50,000	62,200	78,700	92,900	107,100	121,300
~220	26,600	39,000	52,500	66,100	84,600	29,600	42,000	55,500	69,100	87,600	103,200	119,000	134,900
~260	28,700	43,100	58,000	72,900	93,600	31,700	46,100	61,000	75,900	96,600	113,500	131,000	144,500
~300	32,500	47,300	63,500	79,700	102,500	35,500	50,300	66,500	82,700	105,500	123,800	143,000	162,100

※ 出窓の場合はコーナー1ヶ所につきコード式は3,500円、ドラム式は4,500円プラスになります。

style no.51 バルーンフリル													
	コード式					ドラム式							
スワッグ数	1S	2S	3S	4S	5S	1S	2S	3S	4S	5S	6S	7S	8S
H	36~50	~100	~150	~200	~250	40~50	~100	~150	~200	~250	~300	~350	~400
100~140	21,800	32,800	44,700	56,500	71,900	24,800	35,800	47,700	59,500	74,900	88,700	102,300	115,900
~180	24,700	37,000	50,200	63,400	80,800	27,700	40,000	53,200	66,400	83,800	99,000	114,200	129,500
~220	27,700	41,100	55,700	70,200	89,800	30,700	44,100	58,700	73,200	92,800	109,300	126,200	143,100
~260	29,900	45,200	61,100	77,000	98,700	32,900	48,200	64,100	80,000	101,700	119,700	138,200	152,700
~300	33,600	49,400	66,700	83,900	107,600	36,600	52,400	69,700	86,900	110,600	130,000	150,100	170,200

※ 出窓の場合はコーナー1ヶ所につきコード式は3,500円、ドラム式は4,500円プラスになります。

TM-54393



巾 ◇ 100cm 価格 ◇ 1,300円/m
組成 ◇ ポリエステル100%

リピート ◇ タテ cm ヨコ 3.2cm
寸法変化率 ◇ 水洗い/タテ 0.0% ヨコ -0.5%
ドライ/タテ -0.6% ヨコ -1.0%

取扱い表示 ◇ リ-30
防炎性能 ◇ (イ)
Made in Japan

H \ W	~44 1巾(片開き)	~100 2巾	~150 3巾	~200 4巾	~250 5巾	~300 6巾	~350 7巾	~400 8巾
~100	3,500	7,000	10,500	14,000	17,500	21,000	24,500	28,000
~120	4,000	8,000	12,000	16,000	20,000	24,000	28,000	32,000
~140	4,500	9,000	13,500	18,000	22,500	27,000	31,500	36,000
~160	5,000	10,000	15,000	20,000	25,000	30,000	35,000	40,000
~180	5,500	11,000	16,500	22,000	27,500	33,000	38,500	44,000
~200	6,000	12,000	18,000	24,000	30,000	36,000	42,000	48,000
~220	6,500	13,000	19,500	26,000	32,500	39,000	45,500	52,000
~240	7,000	14,000	21,000	28,000	35,000	42,000	49,000	56,000
~260	7,500	15,000	22,500	30,000	37,500	45,000	52,500	60,000
~280	8,000	16,000	24,000	32,000	40,000	48,000	56,000	64,000
約1.5倍ヒダ	~56	~120	~200	~266	~333	~400	~466	~533
フラット1倍ヒダ	~80	~160	~260	~360	~460	~560		

H \ W	~44 1巾(片開き)	~100 2巾	~150 3巾	~200 4巾	~250 5巾	~300 6巾	~350 7巾	~400 8巾
~100	3,800	7,600	11,400	15,200	19,000	22,700	26,500	30,300
~120	4,400	8,700	13,000	17,300	21,600	26,000	30,300	34,600
~140	4,900	9,800	14,600	19,500	24,300	29,200	34,100	38,900
~160	5,400	10,800	16,200	21,600	27,000	32,400	37,800	43,200
~180	6,000	11,900	17,900	23,800	29,700	35,700	41,600	47,600
~200	6,500	13,000	19,500	26,000	32,400	38,900	45,400	51,900
~220	7,100	14,100	21,100	28,100	35,100	42,200	49,200	56,200
~240	7,600	15,200	22,700	30,300	37,800	45,400	53,000	60,500
~260	8,100	16,200	24,300	32,400	40,500	48,600	56,700	64,800
~280	8,700	17,300	26,000	34,600	43,200	51,900	60,500	69,200
約1.5倍ヒダ	~56	~120	~200	~266	~333	~400	~466	~533

H \ W	~44 1巾(片開き)	~100 2巾	~150 3巾	~200 4巾	~250 5巾	~300 6巾	~350 7巾	~400 8巾
~100	4,100	8,200	12,200	16,300	20,300	24,400	28,500	32,500
~120	4,700	9,300	14,000	18,600	23,200	27,900	32,500	37,200
~140	5,300	10,500	15,700	20,900	26,100	31,400	36,600	41,800
~160	5,800	11,600	17,400	23,200	29,000	34,800	40,600	46,400
~180	6,400	12,800	19,200	25,600	31,900	38,300	44,700	51,100
~200	7,000	14,000	20,900	27,900	34,800	41,800	48,800	55,700
~220	7,600	15,100	22,700	30,200	37,700	45,300	52,800	60,400
~240	8,200	16,300	24,400	32,500	40,600	48,800	56,900	65,000
~260	8,700	17,400	26,100	34,800	43,500	52,200	60,900	69,600
~280	9,300	18,600	27,900	37,200	46,400	55,700	65,000	74,300
約1.5倍ヒダ	~56	~120	~200	~266	~333	~400	~466	~533

H \ W	~44 1巾(片開き)	~100 2巾	~150 3巾	~200 4巾	~250 5巾	~300 6巾	~350 7巾	~400 8巾
~100	4,700	9,300	13,900	18,500	23,100	27,800	32,400	37,000
~120	5,300	10,600	15,900	21,200	26,400	31,700	37,000	42,300
~140	6,000	11,900	17,900	23,800	29,700	35,700	41,600	47,600
~160	6,600	13,200	19,800	26,400	33,000	39,600	46,200	52,800
~180	7,300	14,600	21,800	29,100	36,300	43,600	50,900	58,100
~200	8,000	15,900	23,800	31,700	39,600	47,600	55,500	63,400
~220	8,600	17,200	25,800	34,400	42,900	51,500	60,100	68,700
~240	9,300	18,500	27,800	37,000	46,200	55,500	64,700	74,000
~260	9,900	19,800	29,700	39,600	49,500	59,400	69,300	79,200

センタークロス

H \ W	~80	~120	~160	~200	~240	~280	~320
~100	9,300	12,100					
~120	10,300	13,700	18,500				
~140	11,300	15,400	20,700	25,800			
~160	12,100	17,000	23,000	28,500	33,100		
~180	13,300	18,700	25,100	31,200	36,200	43,900	
~200	14,600	20,300	27,300	33,400	40,400	47,700	54,800
~220	15,700	21,900	29,600	36,100	42,500	51,500	58,200
~240	16,900	23,600	31,700	38,800	45,700	55,300	62,500
~260	18,100	26,500	33,900	41,400	48,800	59,100	65,500

セパレーツ

H \ W	~40(1P)	~50(1P)	~60(1P)
~100	10,800	13,400	14,700
~120	12,200	15,100	16,300
~140	13,500	16,700	17,900
~160	14,800	18,200	19,500
~180	16,200	19,900	21,100
~200	17,700	21,500	22,700
~220	18,700	22,900	24,200
~240	20,100	24,300	25,400
~260	21,600	25,800	26,600

レースフレンジ style no.12 (タッセル含む)

H \ W	~80	~120	~160	~200	~240	~280	~320
~100	12,600	16,500					
~120	13,900	18,400	24,500				
~140	15,000	20,300	27,000	33,200			
~160	16,200	22,200	29,500	36,200	41,800		
~180	17,600	24,100	31,900	39,100	45,200	54,500	
~200	19,100	26,000	34,300	41,600	49,700	58,600	66,900
~220	20,500	27,800	36,800	44,600	52,100	62,600	70,700
~240	21,900	29,800	39,300	47,500	55,400	66,700	75,200
~260	23,400	32,900	41,800	50,400	58,900	70,800	78,400

スカラップM型

ウェーブ数	3W	4W	5W	6W	7W	
H \ W	100-130	~160	~190	~240	~290	~330
80-100	15,400	18,700	22,700	27,800	36,700	42,000
~120	16,900	20,900	25,400	30,900	40,800	46,200
~140	18,500	22,800	27,700	33,800	44,500	51,000
~160	20,000	24,200	29,700	36,300	47,800	55,500
~180	26,100	32,000	39,100	51,600	60,400	
~200		34,300	42,000	55,400	65,300	

スカラップW型

ウェーブ数	2W	3W	4W	5W	6W	7W	
H \ W	60-100	~130	~160	~190	~240	~290	~330
80-100	12,200	15,400	18,700	22,700	27,800	36,700	42,000
~120	13,300	16,900	20,900	25,400	30,900	40,800	46,200
~140	14,500	18,500	22,800	27,700	33,800	44,500	51,000
~160	20,000	24,200	29,700	36,300	47,800	55,500	
~180		26,100	32,000	39,100	51,600	60,400	
~200			34,300	42,000	55,400	65,300	

アーチ

H \ W	60-100	~130	~160	~190	~240	~290	~330
80-100	11,900	15,000	18,300	22,200	27,100	35,800	41,000
~120	13,000	16,500	20,500	24,900	30,300	39,900	45,200
~140	14,200	18,100	22,400	27,200	33,200	43,700	50,100
~160	19,600	23,800	29,200	35,700	47,000	54,600	
~180		25,600	31,500	38,500	50,800	59,400	
~200			33,800	41,400	54,500	64,300	

レースフレンジ style no.18

ウェーブ数	3W	4W	5W	6W	7W	
H \ W	100-130	~160	~190	~240	~290	~330
80-100	18,000	21,400	26,100	31,800	42,400	48,400
~120	19,500	23,700	28,800	35,000	46,500	52,600
~140	21,000	25,500	31,100	37,900	50,300	57,500
~160	22,600	26,900	33,100	40,400	53,600	62,000
~180	28,800	35,400	43,200	57,300	66,800	
~200		37,700	46,100	61,100	71,800	

レースフレンジ style no.20

ウェーブ数	2W	3W	4W	5W	6W	7W	
H \ W	60-100	~130	~160	~190	~240	~290	~330
80-100	14,100	18,000	21,400	26,100	31,800	42,400	48,400
~120	15,300	19,500	23,700	28,800	35,000	46,500	52,600
~140	16,500	21,000	25,500	31,100	37,900	50,300	57,500
~160	22,600	26,900	33,100	40,400	53,600	62,000	
~180		28,800	35,400	43,200	57,300	66,800	
~200			37,700	46,100	61,100	71,800	

レースフレンジ style no.27

H \ W	60-100	~130	~160	~190	~240	~290	~330
80-100	13,500	17,200	20,600	25,100	30,500	40,600	46,300
~120	14,700	18,700	22,800	27,800	33,700	44,700	50,500
~140	15,900	20,200	24,600	30,100	36,600	48,400	55,400
~160	21,700	26,100	32,000	39,100	51,700	59,900	
~180		27,900	34,300	41,900	55,500	64,800	
~200			36,600	44,800	59,300	69,700	

		style no.60 プレーンシェード													
		コード式					ドラム式								
H	W	30~45	~90	~140	~190	~240	30~45	~90	~140	~190	~240	~290	~340	~390	
50~100		11,400	15,500	21,400	25,500	31,500	14,400	18,500	24,400	28,500	34,500	41,700	47,800	52,600	
	~140	12,800	16,900	23,500	27,600	34,300	15,800	19,900	26,500	30,600	37,300	44,700	51,400	56,300	
	~180	14,000	18,300	25,500	29,700	37,100	17,000	21,300	28,500	32,700	40,100	47,600	54,800	59,800	
	~220	15,400	19,700	27,600	31,900	39,800	18,400	22,700	30,600	34,900	42,800	50,600	58,400	63,500	
	~260	16,600	21,000	29,600	34,000	42,500	19,600	24,000	32,600	37,000	45,500	53,400	62,000	67,000	
	~300	17,900	22,500	31,700	36,100	45,400	20,900	25,500	34,700	39,100	48,400	56,500	65,400	70,700	

※ドラム式：仕上り巾39cm以下の場合、仕上り丈は200cmまでとなります。

		スリムシェード	
		コード式	
H	W	18~30	
50~100		16,300	
	~140	18,200	
	~180	19,600	
	~220	21,500	
	~240	22,800	

		style no.50 バルーンプレーン													
		コード式					ドラム式								
スワッグ数		1S	2S	3S	4S	5S	1S	2S	3S	4S	5S	6S	7S	8S	
H	W	36~50	~100	~150	~200	~250	40~50	~100	~150	~200	~250	~300	~350	~400	
100~140		20,400	30,300	41,000	51,800	65,900	23,400	33,300	44,000	54,800	68,900	81,500	93,900	106,400	
	~180	23,300	34,400	46,400	58,400	74,600	26,300	37,400	49,400	61,400	77,600	91,600	105,600	119,700	
	~220	26,200	38,400	51,800	65,100	83,300	29,200	41,400	54,800	68,100	86,300	101,600	117,300	133,000	
	~260	28,300	42,400	57,100	71,800	92,000	31,300	45,400	60,100	74,800	95,000	111,700	129,000	142,300	
	~300	32,000	46,500	62,500	78,500	100,700	35,000	49,500	65,500	81,500	103,700	121,800	140,700	159,500	

※出窓の場合はコーナー1ヶ所につきコード式は3,500円、ドラム式は4,500円プラスになります。

		style no.51 バルーンフリル													
		コード式					ドラム式								
スワッグ数		1S	2S	3S	4S	5S	1S	2S	3S	4S	5S	6S	7S	8S	
H	W	36~50	~100	~150	~200	~250	40~50	~100	~150	~200	~250	~300	~350	~400	
100~140		21,500	32,300	43,900	55,600	70,700	24,500	35,300	46,900	58,600	73,700	87,200	100,600	114,000	
	~180	24,300	36,300	49,300	62,300	79,400	27,300	39,300	52,300	65,300	82,400	97,300	112,300	127,300	
	~220	27,200	40,400	54,700	69,000	88,000	30,200	43,400	57,700	72,000	91,000	107,400	124,000	140,600	
	~260	29,300	44,400	60,000	75,600	96,800	32,300	47,400	63,000	78,600	99,800	117,400	135,600	149,900	
	~300	33,000	48,500	65,400	82,300	105,500	36,000	51,500	68,400	85,300	108,500	127,500	147,300	167,100	

※出窓の場合はコーナー1ヶ所につきコード式は3,500円、ドラム式は4,500円プラスになります。

		style no.S01 ロールソフト		
		スプリング・チェーンタイプ		
H	W	30~60	~80	~90
50~80		27,100	29,600	31,600
	~120	28,600	31,700	33,700
	~160	30,100	33,900	35,900
	~200	32,700	35,700	37,900
	~240		37,800	40,100

※丈は巾の3倍までが限度です。

※ロールソフト加工品は非防災品になります。

TM-54394

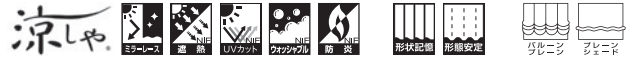

巾 ◇ 100 cm 価 格 ◇ 1,250 円/㎡ リポート ◇ タテ cm ヨコ 9.0 cm 取扱表示 ◇ リ-30 40 炎 形 記 憶 形 態 安 定 約 2 倍 ヒダ 約 2 倍 ヒダ 約 1.5 倍 ヒダ フラット 約 1 倍 ヒダ
 組 成 ◇ ポリエステル100% 寸法変化率 ◇ 水洗い/タテ 0.0% ヨコ -0.3% ドライ/タテ -1.0% ヨコ -0.7% 防 炎 性 能 ◇ (イ) Made in Japan

H	W	~44	~100	~150	~200	~250	~300	~350	~400
		1巾(片開き)	2巾	3巾	4巾	5巾	6巾	7巾	8巾
~100		3,500	6,900	10,300	13,800	17,200	20,600	24,100	27,500
~120		4,000	7,900	11,800	15,700	19,600	23,600	27,500	31,400
~140		4,500	8,900	13,300	17,700	22,100	26,500	30,900	35,300
~160		4,900	9,800	14,700	19,600	24,500	29,400	34,300	39,200
~180		5,400	10,800	16,200	21,600	27,000	32,400	37,800	43,200
~200		5,900	11,800	17,700	23,600	29,400	35,300	41,200	47,100
~220		6,400	12,800	19,200	25,500	31,900	38,300	44,600	51,000
~240		6,900	13,800	20,600	27,500	34,300	41,200	48,100	54,900
~260		7,400	14,700	22,100	29,400	36,800	44,100	51,500	58,800
~280		7,900	15,700	23,600	31,400	39,200	47,100	54,900	62,800
約1.5倍ヒダ		~56	~120	~200	~266	~333	~400	~466	~533
フラット約1倍ヒダ		~80	~160	~260	~360	~460	~560		

H	W	~44	~100	~150	~200	~250	~300	~350	~400
		1巾(片開き)	2巾	3巾	4巾	5巾	6巾	7巾	8巾
~100		3,800	7,500	11,200	14,900	18,600	22,300	26,000	29,700
~120		4,300	8,500	12,800	17,000	21,200	25,500	29,700	34,000
~140		4,800	9,600	14,400	19,100	23,900	28,700	33,400	38,200
~160		5,300	10,600	15,900	21,200	26,500	31,800	37,100	42,400
~180		5,900	11,700	17,500	23,400	29,200	35,000	40,900	46,700
~200		6,400	12,800	19,100	25,500	31,800	38,200	44,600	50,900
~220		6,900	13,800	20,700	27,600	34,500	41,400	48,300	55,200
~240		7,500	14,900	22,300	29,700	37,100	44,600	52,000	59,400
~260		8,000	15,900	23,900	31,800	39,800	47,700	55,700	63,600
~280		8,500	17,000	25,500	34,000	42,400	50,900	59,400	67,900
約1.5倍ヒダ		~56	~120	~200	~266	~333	~400	~466	~533

※片開きはW270cmまで

H	W	~44	~100	~150	~200	~250	~300	~350	~400
		1巾(片開き)	2巾	3巾	4巾	5巾	6巾	7巾	8巾
~100		4,000	8,000	12,000	16,000	20,000	24,000	28,000	32,000
~120		4,600	9,200	13,700	18,300	22,800	27,400	32,000	36,500
~140		5,200	10,300	15,400	20,600	25,700	30,800	36,000	41,100
~160		5,700	11,400	17,100	22,800	28,500	34,200	39,900	45,600
~180		6,300	12,600	18,900	25,100	31,400	37,700	43,900	50,200
~200		6,900	13,700	20,600	27,400	34,200	41,100	47,900	54,800
~220		7,500	14,900	22,300	29,700	37,100	44,500	51,900	59,300
~240		8,000	16,000	24,000	32,000	39,900	47,900	55,900	63,900
~260		8,600	17,100	25,700	34,200	42,800	51,300	59,900	68,400
~280		9,200	18,300	27,400	36,500	45,600	54,800	63,900	73,000
約1.5倍ヒダ		~56	~120	~200	~266	~333	~400	~466	~533

※片開きはW270cmまで

H	W	~44	~100	~150	~200	~250	~300	~350	~400
		1巾(片開き)	2巾	3巾	4巾	5巾	6巾	7巾	8巾
~100		4,600	9,100	13,700	18,200	22,800	27,300	31,900	36,400
~120		5,200	10,400	15,600	20,800	26,000	31,200	36,400	41,600
~140		5,900	11,700	17,600	23,400	29,300	35,100	41,000	46,800
~160		6,500	13,000	19,500	26,000	32,500	39,000	45,500	52,000
~180		7,200	14,300	21,500	28,600	35,800	42,900	50,100	57,200
~200		7,800	15,600	23,400	31,200	39,000	46,800	54,600	62,400
~220		8,500	16,900	25,400	33,800	42,300	50,700	59,200	67,600
~240		9,100	18,200	27,300	36,400	45,500	54,600	63,700	72,800
~260		9,800	19,500	29,300	39,000	48,800	58,500	68,300	78,000

※片開きはW300cmまで

H	W	コード式				ドラム式								
		30~45	~90	~140	~190	~240	30~45	~90	~140	~190	~240	~290	~340	~390
50~100		11,400	15,500	21,300	25,400	31,400	14,400	18,500	24,300	28,400	34,400	41,500	47,600	52,400
~140		12,700	16,900	23,300	27,500	34,100	15,700	19,900	26,300	30,500	37,100	44,500	51,100	56,000
~180		13,900	18,200	25,300	29,600	36,800	16,900	21,200	28,300	32,600	39,800	47,300	54,500	59,500
~220		15,300	19,600	27,400	31,700	39,500	18,300	22,600	30,400	34,700	42,500	50,300	58,000	63,100
~260		16,500	20,900	29,400	33,700	42,200	19,500	23,900	32,400	36,700	45,200	53,100	61,500	66,500
~300		17,800	22,300	31,400	35,800	45,000	20,800	25,300	34,400	38,800	48,000	56,100	64,800	70,200

※ドラム式: 仕上り巾39cm以下の場合、仕上り丈は200cmまでとなります。

H	W	コード式
		18~30
50~100		16,200
~140		18,100
~180		19,500
~220		21,400
~240		22,600

スワッグ数	H	W	コード式					ドラム式							
			1S	2S	3S	4S	5S	1S	2S	3S	4S	5S	6S	7S	8S
100~140			36~50	~100	~150	~200	~250	40~50	~100	~150	~200	~250	~300	~350	~400
~180			20,300	30,100	40,800	51,400	65,400	23,300	33,100	43,800	54,400	68,400	81,000	93,400	105,800
~220			23,100	34,100	46,100	58,000	74,000	26,100	37,100	49,100	61,000	77,000	90,900	104,900	118,900
~260			26,000	38,100	51,400	64,700	82,600	29,000	41,100	54,400	67,700	85,600	100,900	116,400	132,000
~300			28,100	42,100	56,700	71,200	91,200	31,100	45,100	59,700	74,200	94,200	110,800	128,000	141,200
~300			31,700	46,100	62,000	77,800	99,800	34,700	49,100	65,000	80,800	102,800	120,800	139,500	158,200

※出窓の場合はコーナー1ヶ所につきコード式は3,500円、ドラム式は4,500円プラスになります。

TM-54395



巾 ◇ 100cm 価格 ◇ 1,100円/m
組成 ◇ ポリエステル100%

リポート ◇ タテ cm ヨコ cm
寸法変化率 ◇ 水洗い/タテ -0.2% ヨコ -0.5%
ドライ/タテ -0.3% ヨコ -0.3%

取扱い表示 ◇ リ-30
防炎性能 ◇ (イ) あて布使用
Made in Japan

H	W	~44 1巾(片開き)	~100 2巾	~150 3巾	~200 4巾	~250 5巾	~300 6巾	~350 7巾	~400 8巾
~100		3,300	6,500	9,700	12,900	16,100	19,400	22,600	25,800
~120		3,700	7,400	11,100	14,800	18,400	22,100	25,800	29,500
~140		4,200	8,300	12,500	16,600	20,700	24,900	29,000	33,200
~160		4,600	9,200	13,800	18,400	23,000	27,600	32,200	36,800
~180		5,100	10,200	15,200	20,300	25,300	30,400	35,500	40,500
~200		5,600	11,100	16,600	22,100	27,600	33,200	38,700	44,200
~220		6,000	12,000	18,000	24,000	29,900	35,900	41,900	47,900
~240		6,500	12,900	19,400	25,800	32,200	38,700	45,100	51,600
~260		6,900	13,800	20,700	27,600	34,500	41,400	48,300	55,200
~280		7,400	14,800	22,100	29,500	36,800	44,200	51,600	58,900
約1.5倍ヒダ		~56	~120	~200	~266	~333	~400	~466	~533
フラット前ヒダ		~80	~160	~260	~360	~460	~560		

H	W	~44 1巾(片開き)	~100 2巾	~150 3巾	~200 4巾	~250 5巾	~300 6巾	~350 7巾	~400 8巾
~100		3,500	7,000	10,500	14,000	17,500	21,000	24,500	28,000
~120		4,000	8,000	12,000	16,000	20,000	24,000	28,000	32,000
~140		4,500	9,000	13,500	18,000	22,500	27,000	31,500	36,000
~160		5,000	10,000	15,000	20,000	25,000	30,000	35,000	40,000
~180		5,500	11,000	16,500	22,000	27,500	33,000	38,500	44,000
~200		6,000	12,000	18,000	24,000	30,000	36,000	42,000	48,000
~220		6,500	13,000	19,500	26,000	32,500	39,000	45,500	52,000
~240		7,000	14,000	21,000	28,000	35,000	42,000	49,000	56,000
~260		7,500	15,000	22,500	30,000	37,500	45,000	52,500	60,000
~280		8,000	16,000	24,000	32,000	40,000	48,000	56,000	64,000
約1.5倍ヒダ		~56	~120	~200	~266	~333	~400	~466	~533

H	W	~44 1巾(片開き)	~100 2巾	~150 3巾	~200 4巾	~250 5巾	~300 6巾	~350 7巾	~400 8巾
~100		3,800	7,600	11,400	15,200	18,900	22,700	26,500	30,300
~120		4,400	8,700	13,000	17,300	21,600	26,000	30,300	34,600
~140		4,900	9,800	14,600	19,500	24,300	29,200	34,100	38,900
~160		5,400	10,800	16,200	21,600	27,000	32,400	37,800	43,200
~180		6,000	11,900	17,900	23,800	29,700	35,700	41,600	47,600
~200		6,500	13,000	19,500	26,000	32,400	38,900	45,400	51,900
~220		7,100	14,100	21,100	28,100	35,100	42,200	49,200	56,200
~240		7,600	15,200	22,700	30,300	37,800	45,400	53,000	60,500
~260		8,100	16,200	24,300	32,400	40,500	48,600	56,700	64,800
~280		8,700	17,300	26,000	34,600	43,200	51,900	60,500	69,200
約1.5倍ヒダ		~56	~120	~200	~266	~333	~400	~466	~533

H	W	~44 1巾(片開き)	~100 2巾	~150 3巾	~200 4巾	~250 5巾	~300 6巾	~350 7巾	~400 8巾
~100		4,400	8,700	13,100	17,400	21,700	26,100	30,400	34,800
~120		5,000	10,000	14,900	19,900	24,800	29,800	34,800	39,700
~140		5,600	11,200	16,800	22,400	27,900	33,500	39,100	44,700
~160		6,200	12,400	18,600	24,800	31,000	37,200	43,400	49,600
~180		6,900	13,700	20,500	27,300	34,100	41,000	47,800	54,600
~200		7,500	14,900	22,400	29,800	37,200	44,700	52,100	59,600
~220		8,100	16,200	24,200	32,300	40,300	48,400	56,500	64,500
~240		8,700	17,400	26,100	34,800	43,400	52,100	60,800	69,500
~260		9,300	18,600	27,900	37,200	46,500	55,800	65,100	74,400

センタークロス

H	W	~80	~120	~160	~200	~240	~280	~320
~100		8,700	11,200					
~120		9,600	12,800	17,200				
~140		10,500	14,400	19,300	24,000			
~160		11,300	15,800	21,400	26,600	30,800		
~180		12,400	17,400	23,400	29,100	33,800	40,900	
~200		13,500	18,900	25,400	31,100	37,700	44,500	51,200
~220		14,600	20,300	27,500	33,600	39,600	47,900	54,200
~240		15,700	21,900	29,500	36,100	42,500	51,500	58,300
~260		16,800	24,800	31,600	38,500	45,400	55,100	60,900

レースフレンジ style no.12 (タッセル含む)

H	W	~80	~120	~160	~200	~240	~280	~320
~100		12,300	16,000					
~120		13,400	17,800	23,700				
~140		14,600	19,600	26,000	32,000			
~160		15,700	21,400	28,400	34,800	40,200		
~180		17,100	23,200	30,700	37,600	43,400	52,200	
~200		18,400	25,000	32,900	39,900	47,700	56,100	64,000
~220		19,800	26,700	35,300	42,700	49,800	59,900	67,500
~240		21,200	28,600	37,700	45,400	53,000	63,800	71,800
~260		22,500	31,600	40,000	48,200	56,200	67,600	74,700

セパレーツ

H	W	~40(1P)	~50(1P)	~60(1P)
~100		10,400	12,800	14,000
~120		11,700	14,400	15,500
~140		12,900	15,800	17,000
~160		14,200	17,200	18,500
~180		15,500	18,800	20,000
~200		16,900	20,300	21,500
~220		17,900	21,700	22,900
~240		19,200	22,900	24,000
~260		20,600	24,300	25,100

スカラップM型

ウェーブ数	3W	4W	5W	6W	7W	
80~100	14,300	17,500	21,200	25,900	34,100	39,100
~120	15,600	19,600	23,800	28,900	38,000	43,000
~140	17,100	21,300	25,900	31,600	41,500	47,600
~160	18,400	22,600	27,700	33,900	44,500	51,800
~180		24,300	29,800	36,500	48,000	56,300
~200			32,000	39,200	51,500	60,900

レースフレンジ style no.18

ウェーブ数	3W	4W	5W	6W	7W	
80~100	17,400	20,700	25,300	30,800	40,900	46,700
~120	18,700	22,800	27,800	33,800	44,800	50,600
~140	20,100	24,500	29,900	36,400	48,200	55,200
~160	21,500	25,900	31,700	38,700	51,300	59,400
~180		27,600	33,900	41,400	54,800	64,000
~200			36,000	44,100	58,300	68,600

スカラップW型

ウェーブ数	2W	3W	4W	5W	6W	7W	
80~100	11,300	14,300	17,500	21,200	25,900	34,100	39,100
~120	12,400	15,600	19,600	23,800	28,900	38,000	43,000
~140	13,500	17,100	21,300	25,900	31,600	41,500	47,600
~160		18,400	22,600	27,700	33,900	44,500	51,800
~180			24,300	29,800	36,500	48,000	56,300
~200				32,000	39,200	51,500	60,900

レースフレンジ style no.20

ウェーブ数	2W	3W	4W	5W	6W	7W	
80~100	13,600	17,400	20,700	25,300	30,800	40,900	46,700
~120	14,700	18,700	22,800	27,800	33,800	44,800	50,600
~140	15,800	20,100	24,500	29,900	36,400	48,200	55,200
~160		21,500	25,900	31,700	38,700	51,300	59,400
~180			27,600	33,900	41,400	54,800	64,000
~200				36,000	44,100	58,300	68,600

アーチ

H	W	60~100	~130	~160	~190	~240	~290	~330
80~100		11,000	14,000	17,100	20,800	25,400	33,400	38,300
~120		12,100	15,300	19,200	23,300	28,400	37,200	42,200
~140		13,200	16,700	21,000	25,500	31,100	40,700	46,700
~160			18,100	22,300	27,200	33,400	43,700	50,900
~180				24,000	29,400	36,000	47,300	55,500
~200					31,500	38,700	50,700	60,100

レースフレンジ style no.27

H	W	60~100	~130	~160	~190	~240	~290	~330
80~100		13,000	16,500	19,900	24,200	29,500	39,100	44,700
~120		14,100	17,900	22,000	26,700	32,500	42,900	48,600
~140		15,200	19,300	23,700	28,900	35,100	46,400	53,200
~160			20,700	25,000	30,600	37,400	49,500	57,300
~180				26,700	32,800	40,100	53,000	61,900
~200					34,900	42,800	56,500	66,500

レース



style no.50 バルーンプレーン

スラッグ数 H \ W	コード式					ドラム式							
	1S	2S	3S	4S	5S	1S	2S	3S	4S	5S	6S	7S	8S
	36~50	~100	~150	~200	~250	40~50	~100	~150	~200	~250	~300	~350	~400
100-140	19,900	29,500	40,000	50,500	64,100	22,900	32,500	43,000	53,500	67,100	79,400	91,600	103,800
~180	22,700	33,400	45,100	56,800	72,300	25,700	36,400	48,100	59,800	75,300	89,000	102,700	116,500
~220	25,400	37,200	50,200	63,200	80,600	28,400	40,200	53,200	66,200	83,600	98,600	113,800	129,100
~260	27,400	41,100	55,300	69,500	88,800	30,400	44,100	58,300	72,500	91,800	108,100	125,000	137,800
~300	30,900	45,000	60,400	75,900	97,100	33,900	48,000	63,400	78,900	100,100	117,700	136,100	154,400

※ 出窓の場合はコーナー1ヶ所につきコード式は3,500円、ドラム式は4,500円プラスになります。



style no.51 バルーンフリル

スラッグ数 H \ W	コード式					ドラム式							
	1S	2S	3S	4S	5S	1S	2S	3S	4S	5S	6S	7S	8S
	36~50	~100	~150	~200	~250	40~50	~100	~150	~200	~250	~300	~350	~400
100-140	20,800	31,200	42,500	53,700	68,100	23,800	34,200	45,500	56,700	71,100	84,300	97,300	110,300
~180	23,500	35,100	47,600	60,100	76,400	26,500	38,100	50,600	63,100	79,400	93,900	108,400	122,900
~220	26,300	38,900	52,700	66,500	84,600	29,300	41,900	55,700	69,500	87,600	103,400	119,500	135,600
~260	28,300	42,800	57,800	72,800	92,900	31,300	45,800	60,800	75,800	95,900	113,000	130,600	144,200
~300	31,800	46,600	62,900	79,200	101,100	34,800	49,600	65,900	82,200	104,100	122,500	141,700	160,800

※ 出窓の場合はコーナー1ヶ所につきコード式は3,500円、ドラム式は4,500円プラスになります。



style no.S01 ロールソフト

スプリング・チェーンタイプ

H \ W	スプリング・チェーンタイプ		
	30~60	~80	~90
50-80	26,900	29,400	31,400
~120	28,400	31,500	33,500
~160	29,800	33,600	35,600
~200	32,400	35,400	37,600
~240		37,300	39,600

※ 丈は巾の3倍までが限度です。

※ ロールソフト加工品は非防災品になります。

TM-54396



巾 ◇ 100cm 価格 ◇ 1,100円/m
組成 ◇ ポリエステル100%

リピート ◇ タテ cm ヨコ cm
寸法変化率 ◇ 水洗い/タテ -0.5% ヨコ 0.0%
ドライ/タテ -1.0% ヨコ -0.5%

取扱い表示 ◇ リ-30
防炎性能 ◇ (イ) あて布使用
Made in Japan

H	W	~44 1巾(片開き)	~100 2巾	~150 3巾	~200 4巾	~250 5巾	~300 6巾	~350 7巾	~400 8巾
~100		3,300	6,500	9,700	12,900	16,100	19,400	22,600	25,800
~120		3,700	7,400	11,100	14,800	18,400	22,100	25,800	29,500
~140		4,200	8,300	12,500	16,600	20,700	24,900	29,000	33,200
~160		4,600	9,200	13,800	18,400	23,000	27,600	32,200	36,800
~180		5,100	10,200	15,200	20,300	25,300	30,400	35,500	40,500
~200		5,600	11,100	16,600	22,100	27,600	33,200	38,700	44,200
~220		6,000	12,000	18,000	24,000	29,900	35,900	41,900	47,900
~240		6,500	12,900	19,400	25,800	32,200	38,700	45,100	51,600
~260		6,900	13,800	20,700	27,600	34,500	41,400	48,300	55,200
~280		7,400	14,800	22,100	29,500	36,800	44,200	51,600	58,900
約1.5倍ヒダ		~56	~120	~200	~266	~333	~400	~466	~533
フラット前ヒダ		~80	~160	~260	~360	~460	~560		

H	W	~44 1巾(片開き)	~100 2巾	~150 3巾	~200 4巾	~250 5巾	~300 6巾	~350 7巾	~400 8巾
~100		3,500	7,000	10,500	14,000	17,500	21,000	24,500	28,000
~120		4,000	8,000	12,000	16,000	20,000	24,000	28,000	32,000
~140		4,500	9,000	13,500	18,000	22,500	27,000	31,500	36,000
~160		5,000	10,000	15,000	20,000	25,000	30,000	35,000	40,000
~180		5,500	11,000	16,500	22,000	27,500	33,000	38,500	44,000
~200		6,000	12,000	18,000	24,000	30,000	36,000	42,000	48,000
~220		6,500	13,000	19,500	26,000	32,500	39,000	45,500	52,000
~240		7,000	14,000	21,000	28,000	35,000	42,000	49,000	56,000
~260		7,500	15,000	22,500	30,000	37,500	45,000	52,500	60,000
~280		8,000	16,000	24,000	32,000	40,000	48,000	56,000	64,000
約1.5倍ヒダ		~56	~120	~200	~266	~333	~400	~466	~533

H	W	~44 1巾(片開き)	~100 2巾	~150 3巾	~200 4巾	~250 5巾	~300 6巾	~350 7巾	~400 8巾
~100		3,800	7,600	11,400	15,200	18,900	22,700	26,500	30,300
~120		4,400	8,700	13,000	17,300	21,600	26,000	30,300	34,600
~140		4,900	9,800	14,600	19,500	24,300	29,200	34,100	38,900
~160		5,400	10,800	16,200	21,600	27,000	32,400	37,800	43,200
~180		6,000	11,900	17,900	23,800	29,700	35,700	41,600	47,600
~200		6,500	13,000	19,500	26,000	32,400	38,900	45,400	51,900
~220		7,100	14,100	21,100	28,100	35,100	42,200	49,200	56,200
~240		7,600	15,200	22,700	30,300	37,800	45,400	53,000	60,500
~260		8,100	16,200	24,300	32,400	40,500	48,600	56,700	64,800
~280		8,700	17,300	26,000	34,600	43,200	51,900	60,500	69,200
約1.5倍ヒダ		~56	~120	~200	~266	~333	~400	~466	~533

H	W	~44 1巾(片開き)	~100 2巾	~150 3巾	~200 4巾	~250 5巾	~300 6巾	~350 7巾	~400 8巾
~100		4,400	8,700	13,100	17,400	21,700	26,100	30,400	34,800
~120		5,000	10,000	14,900	19,900	24,800	29,800	34,800	39,700
~140		5,600	11,200	16,800	22,400	27,900	33,500	39,100	44,700
~160		6,200	12,400	18,600	24,800	31,000	37,200	43,400	49,600
~180		6,900	13,700	20,500	27,300	34,100	41,000	47,800	54,600
~200		7,500	14,900	22,400	29,800	37,200	44,700	52,100	59,600
~220		8,100	16,200	24,200	32,300	40,300	48,400	56,500	64,500
~240		8,700	17,400	26,100	34,800	43,400	52,100	60,800	69,500
~260		9,300	18,600	27,900	37,200	46,500	55,800	65,100	74,400

センタークロス

H	W	~80	~120	~160	~200	~240	~280	~320
~100		8,700	11,200					
~120		9,600	12,800	17,200				
~140		10,500	14,400	19,300	24,000			
~160		11,300	15,800	21,400	26,600	30,800		
~180		12,400	17,400	23,400	29,100	33,800	40,900	
~200		13,500	18,900	25,400	31,100	37,700	44,500	51,200
~220		14,600	20,300	27,500	33,600	39,600	47,900	54,200
~240		15,700	21,900	29,500	36,100	42,500	51,500	58,300
~260		16,800	24,800	31,600	38,500	45,400	55,100	60,900

レースフレンジ style no.12 (タッセル含む)

H	W	~80	~120	~160	~200	~240	~280	~320
~100		12,300	16,000					
~120		13,400	17,800	23,700				
~140		14,600	19,600	26,000	32,000			
~160		15,700	21,400	28,400	34,800	40,200		
~180		17,100	23,200	30,700	37,600	43,400	52,200	
~200		18,400	25,000	32,900	39,900	47,700	56,100	64,000
~220		19,800	26,700	35,300	42,700	49,800	59,900	67,500
~240		21,200	28,600	37,700	45,400	53,000	63,800	71,800
~260		22,500	31,600	40,000	48,200	56,200	67,600	74,700

セパレーツ

H	W	~40(1P)	~50(1P)	~60(1P)
~100		10,400	12,800	14,000
~120		11,700	14,400	15,500
~140		12,900	15,800	17,000
~160		14,200	17,200	18,500
~180		15,500	18,800	20,000
~200		16,900	20,300	21,500
~220		17,900	21,700	22,900
~240		19,200	22,900	24,000
~260		20,600	24,300	25,100

スカラップM型

ウェーブ数	3W	4W	5W	6W	7W	
80~100	14,300	17,500	21,200	25,900	34,100	39,100
~120	15,600	19,600	23,800	28,900	38,000	43,000
~140	17,100	21,300	25,900	31,600	41,500	47,600
~160	18,400	22,600	27,700	33,900	44,500	51,800
~180		24,300	29,800	36,500	48,000	56,300
~200			32,000	39,200	51,500	60,900

レースフレンジ style no.18

ウェーブ数	3W	4W	5W	6W	7W	
80~100	17,400	20,700	25,300	30,800	40,900	46,700
~120	18,700	22,800	27,800	33,800	44,800	50,600
~140	20,100	24,500	29,900	36,400	48,200	55,200
~160	21,500	25,900	31,700	38,700	51,300	59,400
~180		27,600	33,900	41,400	54,800	64,000
~200			36,000	44,100	58,300	68,600

スカラップW型

ウェーブ数	2W	3W	4W	5W	6W	7W	
80~100	11,300	14,300	17,500	21,200	25,900	34,100	39,100
~120	12,400	15,600	19,600	23,800	28,900	38,000	43,000
~140	13,500	17,100	21,300	25,900	31,600	41,500	47,600
~160		18,400	22,600	27,700	33,900	44,500	51,800
~180			24,300	29,800	36,500	48,000	56,300
~200				32,000	39,200	51,500	60,900

レースフレンジ style no.20

ウェーブ数	2W	3W	4W	5W	6W	7W	
80~100	13,600	17,400	20,700	25,300	30,800	40,900	46,700
~120	14,700	18,700	22,800	27,800	33,800	44,800	50,600
~140	15,800	20,100	24,500	29,900	36,400	48,200	55,200
~160		21,500	25,900	31,700	38,700	51,300	59,400
~180			27,600	33,900	41,400	54,800	64,000
~200				36,000	44,100	58,300	68,600

アーチ

H	W	60~100	~130	~160	~190	~240	~290	~330
80~100		11,000	14,000	17,100	20,800	25,400	33,400	38,300
~120		12,100	15,300	19,200	23,300	28,400	37,200	42,200
~140		13,200	16,700	21,000	25,500	31,100	40,700	46,700
~160			18,100	22,300	27,200	33,400	43,700	50,900
~180				24,000	29,400	36,000	47,300	55,500
~200					31,500	38,700	50,700	60,100

レースフレンジ style no.27

H	W	60~100	~130	~160	~190	~240	~290	~330
80~100		13,000	16,500	19,900	24,200	29,500	39,100	44,700
~120		14,100	17,900	22,000	26,700	32,500	42,900	48,600
~140		15,200	19,300	23,700	28,900	35,100	46,400	53,200
~160			20,700	25,000	30,600	37,400	49,500	57,300
~180				26,700	32,800	40,100	53,000	61,900
~200					34,900	42,800	56,500	66,500

レース

		style no.60 プレーンシェード												
		コード式					ドラム式							
H	W	30~45	~90	~140	~190	~240	30~45	~90	~140	~190	~240	~290	~340	~390
50~100		11,200	15,300	21,000	25,100	30,900	14,200	18,300	24,000	28,100	33,900	41,000	47,000	51,800
	~140	12,500	16,700	22,900	27,100	33,500	15,500	19,700	25,900	30,100	36,500	43,900	50,300	55,200
	~180	13,700	17,900	24,800	29,100	36,000	16,700	20,900	27,800	32,100	39,000	46,500	53,400	58,400
	~220	14,900	19,300	26,700	31,000	38,600	17,900	22,300	29,700	34,000	41,600	49,300	56,700	61,900
	~260	16,100	20,600	28,600	33,000	41,100	19,100	23,600	31,600	36,000	44,100	52,000	60,100	65,100
	~300	17,400	21,900	30,600	35,000	43,700	20,400	24,900	33,600	38,000	46,700	54,800	63,200	68,500

※ドラム式：仕上り巾39cm以下の場合、仕上り丈は200cmまでとなります。

		スリムシェード	
		コード式	
H	W	18~30	
50~100		16,100	
	~140	18,000	
	~180	19,300	
	~220	21,200	
	~240	22,300	

		style no.50 バルーンプレーン												
		コード式					ドラム式							
スワッグ数		1S	2S	3S	4S	5S	1S	2S	3S	4S	5S	6S	7S	8S
H	W	36~50	~100	~150	~200	~250	40~50	~100	~150	~200	~250	~300	~350	~400
100~140		19,900	29,500	40,000	50,500	64,100	22,900	32,500	43,000	53,500	67,100	79,400	91,600	103,800
	~180	22,700	33,400	45,100	56,800	72,300	25,700	36,400	48,100	59,800	75,300	89,000	102,700	116,500
	~220	25,400	37,200	50,200	63,200	80,600	28,400	40,200	53,200	66,200	83,600	98,600	113,800	129,100
	~260	27,400	41,100	55,300	69,500	88,800	30,400	44,100	58,300	72,500	91,800	108,100	125,000	137,800
	~300	30,900	45,000	60,400	75,900	97,100	33,900	48,000	63,400	78,900	100,100	117,700	136,100	154,400

※出窓の場合はコーナー1ヶ所につきコード式は3,500円、ドラム式は4,500円プラスになります。

		style no.51 バルーンフリル												
		コード式					ドラム式							
スワッグ数		1S	2S	3S	4S	5S	1S	2S	3S	4S	5S	6S	7S	8S
H	W	36~50	~100	~150	~200	~250	40~50	~100	~150	~200	~250	~300	~350	~400
100~140		20,800	31,200	42,500	53,700	68,100	23,800	34,200	45,500	56,700	71,100	84,300	97,300	110,300
	~180	23,500	35,100	47,600	60,100	76,400	26,500	38,100	50,600	63,100	79,400	93,900	108,400	122,900
	~220	26,300	38,900	52,700	66,500	84,600	29,300	41,900	55,700	69,500	87,600	103,400	119,500	135,600
	~260	28,300	42,800	57,800	72,800	92,900	31,300	45,800	60,800	75,800	95,900	113,000	130,600	144,200
	~300	31,800	46,600	62,900	79,200	101,100	34,800	49,600	65,900	82,200	104,100	122,500	141,700	160,800

※出窓の場合はコーナー1ヶ所につきコード式は3,500円、ドラム式は4,500円プラスになります。

		style no.S01 ロールソフト		
		スプリング・チェーンタイプ		
H	W	30~60	~80	~90
50~80		26,900	29,400	31,400
	~120	28,400	31,500	33,500
	~160	29,800	33,600	35,600
	~200	32,400	35,400	37,600
	~240		37,300	39,600

※丈は巾の3倍までが限度です。

※ロールソフト加工品は非防炎品になります。

TM-54398



巾 ◇ 100cm 価格 ◇ 1,150円/m
組成 ◇ ポリエステル100%

リピート ◇ タテcm ヨコcm
寸法変化率 ◇ 水洗い/タテ 0.0% ヨコ 0.0%
ドライ/タテ -0.3% ヨコ 0.2%

取扱い表示 ◇ リ-30
防炎性能 ◇ (イ)
Made in Japan

H	W	~44 1巾(片開き)	~100 2巾	~150 3巾	~200 4巾	~250 5巾	~300 6巾	~350 7巾	~400 8巾
~100		3,300	6,600	9,900	13,200	16,500	19,800	23,100	26,400
~120		3,800	7,600	11,300	15,100	18,800	22,600	26,400	30,100
~140		4,300	8,500	12,700	17,000	21,200	25,400	29,700	33,900
~160		4,700	9,400	14,100	18,800	23,500	28,200	32,900	37,600
~180		5,200	10,400	15,600	20,700	25,900	31,100	36,200	41,400
~200		5,700	11,300	17,000	22,600	28,200	33,900	39,500	45,200
~220		6,200	12,300	18,400	24,500	30,600	36,700	42,800	48,900
~240		6,600	13,200	19,800	26,400	32,900	39,500	46,100	52,700
~260		7,100	14,100	21,200	28,200	35,300	42,300	49,400	56,400
~280		7,600	15,100	22,600	30,100	37,600	45,200	52,700	60,200
約1.5倍ヒダ		~56	~120	~200	~266	~333	~400	~466	~533
フラット約1倍ヒダ		~80	~160	~260	~360	~460	~560		

H	W	~44 1巾(片開き)	~100 2巾	~150 3巾	~200 4巾	~250 5巾	~300 6巾	~350 7巾	~400 8巾
~100		3,600	7,200	10,800	14,300	17,900	21,500	25,000	28,600
~120		4,100	8,200	12,300	16,400	20,400	24,500	28,600	32,700
~140		4,600	9,200	13,800	18,400	23,000	27,600	32,200	36,800
~160		5,100	10,200	15,300	20,400	25,500	30,600	35,700	40,800
~180		5,700	11,300	16,900	22,500	28,100	33,700	39,300	44,900
~200		6,200	12,300	18,400	24,500	30,600	36,800	42,900	49,000
~220		6,700	13,300	19,900	26,600	33,200	39,800	46,500	53,100
~240		7,200	14,300	21,500	28,600	35,700	42,900	50,000	57,200
~260		7,700	15,300	23,000	30,600	38,300	45,900	53,600	61,200
~280		8,200	16,400	24,500	32,700	40,800	49,000	57,200	65,300
約1.5倍ヒダ		~56	~120	~200	~266	~333	~400	~466	~533

H	W	~44 1巾(片開き)	~100 2巾	~150 3巾	~200 4巾	~250 5巾	~300 6巾	~350 7巾	~400 8巾
~100		3,900	7,700	11,600	15,400	19,300	23,100	27,000	30,800
~120		4,400	8,800	13,200	17,600	22,000	26,400	30,800	35,200
~140		5,000	9,900	14,900	19,800	24,800	29,700	34,700	39,600
~160		5,500	11,000	16,500	22,000	27,500	33,000	38,500	44,000
~180		6,100	12,100	18,200	24,200	30,300	36,300	42,400	48,400
~200		6,600	13,200	19,800	26,400	33,000	39,600	46,200	52,800
~220		7,200	14,300	21,500	28,600	35,800	42,900	50,100	57,200
~240		7,700	15,400	23,100	30,800	38,500	46,200	53,900	61,600
~260		8,300	16,500	24,800	33,000	41,300	49,500	57,800	66,000
~280		8,800	17,600	26,400	35,200	44,000	52,800	61,600	70,400
約1.5倍ヒダ		~56	~120	~200	~266	~333	~400	~466	~533

H	W	~44 1巾(片開き)	~100 2巾	~150 3巾	~200 4巾	~250 5巾	~300 6巾	~350 7巾	~400 8巾
~100		4,500	8,900	13,300	17,700	22,100	26,500	30,900	35,300
~120		5,100	10,100	15,200	20,200	25,200	30,300	35,300	40,400
~140		5,700	11,400	17,100	22,700	28,400	34,100	39,700	45,400
~160		6,300	12,600	18,900	25,200	31,500	37,800	44,100	50,400
~180		7,000	13,900	20,800	27,800	34,700	41,600	48,600	55,500
~200		7,600	15,200	22,700	30,300	37,800	45,400	53,000	60,500
~220		8,200	16,400	24,600	32,800	41,000	49,200	57,400	65,600
~240		8,900	17,700	26,500	35,300	44,100	53,000	61,800	70,600
~260		9,500	18,900	28,400	37,800	47,300	56,700	66,200	75,600

センタークロス

H	W	~80	~120	~160	~200	~240	~280	~320
~100		8,900	11,400					
~120		9,800	13,000	17,500				
~140		10,700	14,600	19,600	24,500			
~160		11,500	16,100	21,800	27,000	31,400		
~180		12,600	17,700	23,800	29,600	34,400	41,700	
~200		13,800	19,300	25,900	31,600	38,400	45,300	52,100
~220		14,800	20,700	28,000	34,300	40,300	48,800	55,200
~240		16,000	22,400	30,100	36,800	43,300	52,500	59,300
~260		17,100	25,200	32,200	39,300	46,300	56,100	62,000

セバレーツ

H	W	~40(1P)	~50(1P)	~60(1P)
~100		10,500	12,900	14,200
~120		11,800	14,600	15,700
~140		13,100	16,000	17,300
~160		14,400	17,500	18,700
~180		15,600	19,000	20,300
~200		17,100	20,600	21,800
~220		18,100	22,000	23,200
~240		19,400	23,300	24,300
~260		20,800	24,700	25,500

レースフレンジ style no.12 (タッセル含む)

H	W	~80	~120	~160	~200	~240	~280	~320
~100		12,400	16,100					
~120		13,600	18,000	23,900				
~140		14,700	19,800	26,200	32,300			
~160		15,800	21,600	28,700	35,100	40,600		
~180		17,200	23,400	31,000	37,900	43,800	52,800	
~200		18,600	25,200	33,300	40,300	48,200	56,700	64,800
~220		19,900	27,000	35,700	43,200	50,400	60,600	68,300
~240		21,400	28,900	38,100	46,000	53,600	64,500	72,700
~260		22,700	32,000	40,400	48,800	56,900	68,400	75,600

スカラップM型

ウェーブ数	3W	4W	5W	6W	7W	
80~100	14,600	17,800	21,600	26,400	34,700	39,800
~120	16,000	19,900	24,200	29,400	38,700	43,800
~140	17,400	21,700	26,400	32,100	42,200	48,400
~160	18,800	23,000	28,200	34,500	45,300	52,700
~180		24,800	30,400	37,200	48,900	57,300
~200			32,500	39,900	52,500	62,000

スカラップW型

ウェーブ数	2W	3W	4W	5W	6W	7W	
80~100	11,500	14,600	17,800	21,600	26,400	34,700	39,800
~120	12,600	16,000	19,900	24,200	29,400	38,700	43,800
~140	13,800	17,400	21,700	26,400	32,100	42,200	48,400
~160		18,800	23,000	28,200	34,500	45,300	52,700
~180			24,800	30,400	37,200	48,900	57,300
~200				32,500	39,900	52,500	62,000

アーチ

H	W	60~100	~130	~160	~190	~240	~290	~330
80~100		11,200	14,200	17,400	21,100	25,800	34,000	38,900
~120		12,400	15,600	19,600	23,700	28,900	37,900	42,900
~140		13,500	17,100	21,300	25,900	31,600	41,500	47,600
~160			18,500	22,700	27,700	33,900	44,500	51,800
~180				24,400	29,900	36,600	48,100	56,500
~200					32,100	39,400	51,700	61,200

レースフレンジ style no.18

ウェーブ数	3W	4W	5W	6W	7W	
80~100	17,500	20,900	25,500	31,100	41,300	47,100
~120	18,900	23,000	28,100	34,100	45,200	51,100
~140	20,400	24,800	30,200	36,800	48,700	55,800
~160	21,800	26,100	32,100	39,200	51,800	60,000
~180		27,900	34,200	41,800	55,400	64,700
~200			36,400	44,600	59,000	69,400

レースフレンジ style no.20

ウェーブ数	2W	3W	4W	5W	6W	7W	
80~100	13,700	17,500	20,900	25,500	31,100	41,300	47,100
~120	14,800	18,900	23,000	28,100	34,100	45,200	51,100
~140	16,000	20,400	24,800	30,200	36,800	48,700	55,800
~160		21,800	26,100	32,100	39,200	51,800	60,000
~180			27,900	34,200	41,800	55,400	64,700
~200				36,400	44,600	59,000	69,400

レースフレンジ style no.27

H	W	60~100	~130	~160	~190	~240	~290	~330
80~100		13,100	16,700	20,000	24,400	29,800	39,500	45,100
~120		14,200	18,100	22,200	27,000	32,800	43,400	49,100
~140		15,400	19,500	23,900	29,200	35,500	46,900	53,700
~160			21,000	25,300	31,000	37,900	50,000	58,000
~180				27,000	33,200	40,500	53,600	62,600
~200					35,300	43,300	57,200	67,300

style no.60 プレーンシェード														
		コード式					ドラム式							
H	W	30~45	~90	~140	~190	~240	30~45	~90	~140	~190	~240	~290	~340	~390
50~100		11,300	15,400	21,100	25,200	31,100	14,300	18,400	24,100	28,200	34,100	41,200	47,200	52,000
	~140	12,500	16,700	23,100	27,200	33,700	15,500	19,700	26,100	30,200	36,700	44,100	50,600	55,500
	~180	13,800	18,000	25,000	29,200	36,300	16,800	21,000	28,000	32,200	39,300	46,800	53,800	58,800
	~220	15,000	19,400	26,900	31,200	38,900	18,000	22,400	29,900	34,200	41,900	49,700	57,100	62,300
	~260	16,300	20,700	28,900	33,300	41,500	19,300	23,700	31,900	36,300	44,500	52,300	60,600	65,600
	~300	17,500	22,000	30,800	35,300	44,100	20,500	25,000	33,800	38,300	47,100	55,200	63,700	69,100

※ドラム式：仕上り巾39cm以下の場合、仕上り丈は200cmまでとなります。

スリムシェード	
コード式	
H	W
50~100	18~30
	16,200
	~140
	18,000
	~180
	19,400
	~220
	21,300
	~240
	22,400

style no.50 バルーンブレード														
		コード式					ドラム式							
スワッグ数		1S	2S	3S	4S	5S	1S	2S	3S	4S	5S	6S	7S	8S
H	W	36~50	~100	~150	~200	~250	40~50	~100	~150	~200	~250	~300	~350	~400
100~140		20,100	29,700	40,300	50,800	64,500	23,100	32,700	43,300	53,800	67,500	79,900	92,200	104,500
	~180	22,800	33,600	45,400	57,200	72,900	25,800	36,600	48,400	60,200	75,900	89,700	103,500	117,300
	~220	25,600	37,500	50,600	63,700	81,200	28,600	40,500	53,600	66,700	84,200	99,300	114,700	130,100
	~260	27,600	41,400	55,800	70,100	89,600	30,600	44,400	58,800	73,100	92,600	109,000	126,000	138,900
	~300	31,200	45,300	61,000	76,500	98,000	34,200	48,300	64,000	79,500	101,000	118,700	137,200	155,700

※出窓の場合はコーナー1ヶ所につきコード式は3,500円、ドラム式は4,500円プラスになります。

style no.51 バルーンフリル														
		コード式					ドラム式							
スワッグ数		1S	2S	3S	4S	5S	1S	2S	3S	4S	5S	6S	7S	8S
H	W	36~50	~100	~150	~200	~250	40~50	~100	~150	~200	~250	~300	~350	~400
100~140		21,000	31,500	42,800	54,200	68,800	24,000	34,500	45,800	57,200	71,800	85,000	98,100	111,200
	~180	23,700	35,400	48,000	60,700	77,100	26,700	38,400	51,000	63,700	80,100	94,700	109,400	124,000
	~220	26,500	39,300	53,200	67,100	85,500	29,500	42,300	56,200	70,100	88,500	104,400	120,600	136,800
	~260	28,500	43,200	58,300	73,500	93,900	31,500	46,200	61,300	76,500	96,900	114,100	131,800	145,600
	~300	32,100	47,100	63,500	79,900	102,200	35,100	50,100	66,500	82,900	105,200	123,800	143,100	162,400

※出窓の場合はコーナー1ヶ所につきコード式は3,500円、ドラム式は4,500円プラスになります。

style no.S01 ロールソフト			
スプリング・チェーンタイプ			
H	W	30~60	~90
50~80		27,000	29,500
	~120	28,400	31,500
	~160	29,900	33,700
	~200	32,500	35,500
	~240	37,400	39,700

※丈は巾の3倍までが限度です。

※ロールソフト加工品は非防災品になります。

TM-54399

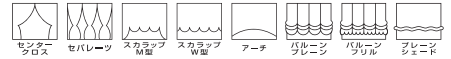

巾 ◇ 150cm 価格 ◇ 1,050円/㎡

リポート ◇ タテ cm ヨコ cm
寸法変化率 ◇ 水洗い/タテ -0.3% ヨコ -0.2%
ドライ/タテ -0.8% ヨコ -0.8%

取扱い表示 ◇ リ-30 40 50 60 70 80 90 100 110 120 130 140 150 160 170 180 190 200 210 220 230 240 250 260 270 280 290 300 310 320 330 340 350 360 370 380 390 400 410 420 430 440 450 460 470 480 490 500
防炎性能 ◇ -
Made in Japan

H \ W	~67 1巾(片開き)	~150 2巾	~225 3巾	~300 4巾	~375 5巾	~450 6巾	~525 7巾	~600 8巾
~100	4,000	8,000	12,000	16,000	20,000	24,000	28,000	32,000
~120	4,600	9,200	13,700	18,300	22,800	27,400	32,000	36,500
~140	5,200	10,300	15,400	20,600	25,700	30,800	36,000	41,100
~160	5,700	11,400	17,100	22,800	28,500	34,200	39,900	45,600
~180	6,300	12,600	18,900	25,100	31,400	37,700	43,900	50,200
~200	6,900	13,700	20,600	27,400	34,200	41,100	47,900	54,800
~220	7,500	14,900	22,300	29,700	37,100	44,500	51,900	59,300
~240	8,000	16,000	24,000	32,000	39,900	47,900	55,900	63,900
~260	8,600	17,100	25,700	34,200	42,800	51,300	59,900	68,400
~280	9,200	18,300	27,400	36,500	45,600	54,800	63,900	73,000
約1.5倍ヒダ	~88	~200	~300	~400	~500	~600	~700	~800
フラット約1倍ヒダ	~130	~260	~410	~560				

H \ W	~67 1巾(片開き)	~150 2巾	~225 3巾	~300 4巾	~375 5巾	~450 6巾	~525 7巾	~600 8巾
~100	4,500	8,900	13,300	17,700	22,100	26,500	30,900	35,300
~120	5,100	10,100	15,200	20,200	25,200	30,300	35,300	40,300
~140	5,700	11,400	17,100	22,700	28,400	34,100	39,700	45,000
~160	6,300	12,600	18,900	25,200	31,500	37,800	44,100	50,400
~180	7,000	13,900	20,800	27,800	34,700	41,600	48,600	55,500
~200	7,600	15,200	22,700	30,300	37,800	45,400	53,000	60,600
~220	8,200	16,400	24,600	32,800	41,000	49,200	57,400	65,800
~240	8,900	17,700	26,500	35,300	44,100	53,000	61,800	70,200
~260	9,500	18,900	28,400	37,800	47,300	56,700	66,200	75,600
~280	10,100	20,200	30,300	40,400	50,400	60,500	70,600	81,000
約1.5倍ヒダ	~88	~200	~300	~400	~500			

H \ W	~67 1巾(片開き)	~150 2巾	~225 3巾	~300 4巾	~375 5巾	~450 6巾	~525 7巾	~600 8巾
~100	4,900	9,700	14,500	19,400	24,200	29,000	33,900	38,700
~120	5,600	11,100	16,600	22,100	27,600	33,200	38,700	43,500
~140	6,300	12,500	18,700	24,900	31,100	37,300	43,500	49,300
~160	6,900	13,800	20,700	27,600	34,500	41,400	48,300	55,200
~180	7,600	15,200	22,800	30,400	38,000	45,600	53,200	61,000
~200	8,300	16,600	24,900	33,200	41,400	49,700	58,000	66,800
~220	9,000	18,000	27,000	35,900	44,900	53,900	62,800	72,600
~240	9,700	19,400	29,000	38,700	48,300	58,000	67,700	78,400
~260	10,400	20,700	31,100	41,400	51,800	62,100	72,500	83,200
~280	11,100	22,100	33,200	44,200	55,200	66,300	77,300	88,000
約1.5倍ヒダ	~88	~200	~300	~400	~500			

H \ W	~67 1巾(片開き)	~150 2巾	~225 3巾	~300 4巾	~375 5巾	~450 6巾	~525 7巾	~600 8巾
~100	5,700	11,400	17,100	22,700	28,400	34,100	39,700	45,400
~120	6,500	13,000	19,500	26,000	32,400	38,900	45,400	51,900
~140	7,300	14,600	21,900	29,200	36,500	43,800	51,100	58,400
~160	8,100	16,200	24,300	32,400	40,500	48,600	56,700	64,800
~180	9,000	17,900	26,800	35,700	44,600	53,500	62,400	71,300
~200	9,800	19,500	29,200	38,900	48,600	58,400	68,100	77,800
~220	10,600	21,100	31,600	42,200	52,700	63,200	73,800	84,300
~240	11,400	22,700	34,100	45,400	56,700	68,100	79,400	90,800
~260	12,200	24,300	36,500	48,600	60,800	72,900	85,100	97,200

H \ W	~80	~120	~160	~200	~240	~280	~320
~100	8,300	9,600					
~120	9,200	11,000	15,200				
~140	10,000	12,300	17,000	21,700			
~160	10,700	13,500	18,800	23,900	26,300		
~180	11,800	14,800	20,600	26,100	28,800	35,600	
~200	12,800	16,100	22,300	27,900	32,300	38,700	45,300
~220	13,800	17,300	24,200	30,200	33,800	41,800	48,000
~240	14,900	18,700	25,900	32,400	36,300	44,900	51,500
~260	15,900	21,200	27,800	34,600	38,800	47,900	53,600

H \ W	~40(1P)	~50(1P)	~60(1P)
~100	9,900	11,200	12,300
~120	11,100	12,400	13,500
~140	12,300	13,600	14,800
~160	13,600	14,800	16,000
~180	14,700	16,000	17,200
~200	16,100	17,200	18,400
~220	17,100	18,300	19,600
~240	18,300	19,300	20,300
~260	19,600	20,500	21,200

H \ W	~80	~120	~160	~200	~240	~280	~320
~100	13,200	15,000					
~120	14,400	16,600	22,900				
~140	15,500	18,200	25,000	31,500			
~160	16,500	19,800	27,200	34,100	36,900		
~180	17,900	21,500	29,300	36,600	39,700	48,900	
~200	19,300	23,100	31,400	38,800	43,600	52,300	60,800
~220	20,600	24,600	33,600	41,400	45,400	55,700	63,800
~240	22,000	26,300	35,700	43,900	48,200	59,200	67,700
~260	23,300	29,200	37,800	46,500	51,000	62,600	70,100

ウェーブ数	3W	4W	5W	6W	7W	
H \ W	100~130	~160	~190	~240	~290	~330
80~100	12,500	15,600	19,200	22,300	28,400	33,300
~120	13,600	17,500	21,600	24,900	31,700	36,600
~140	14,900	19,000	23,500	27,200	34,600	40,600
~160	16,100	20,100	25,100	29,100	37,000	44,200
~180	17,300	21,600	27,000	31,400	39,900	48,200
~200	18,500	23,100	28,900	33,600	42,800	52,200

ウェーブ数	2W	3W	4W	5W	6W	7W	
H \ W	60~100	~130	~160	~190	~240	~290	~330
80~100	9,600	12,500	15,600	19,200	22,300	28,400	33,300
~120	10,500	13,600	17,500	21,600	24,900	31,700	36,600
~140	11,400	14,900	19,000	23,500	27,200	34,600	40,600
~160	12,300	16,100	20,100	25,100	29,100	37,000	44,200
~180	13,200	17,300	21,600	27,000	31,400	39,900	48,200
~200	14,100	18,500	23,100	28,900	33,600	42,800	52,200

H \ W	60~100	~130	~160	~190	~240	~290	~330
80~100	9,400	12,200	15,300	18,900	22,000	28,000	32,800
~120	10,300	13,400	17,200	21,200	24,500	31,300	36,100
~140	11,200	14,600	18,800	23,200	26,800	34,200	40,100
~160	12,100	15,800	20,600	25,100	29,100	37,000	44,200
~180	13,000	17,000	22,400	27,400	31,400	39,900	48,200
~200	13,900	18,200	24,200	29,700	33,800	43,800	52,200

ウェーブ数	3W	4W	5W	6W	7W	
H \ W	100~130	~160	~190	~240	~290	~330
80~100	17,000	20,400	25,600	28,700	36,800	43,400
~120	18,200	22,300	28,000	31,300	40,100	46,700
~140	19,400	23,800	29,900	33,500	43,000	50,700
~160	20,600	24,900	31,500	35,500	45,400	54,300
~180	21,800	26,400	33,400	37,700	48,300	58,200
~200	23,000	27,900	35,300	40,000	51,200	62,200

ウェーブ数	2W	3W	4W	5W	6W	7W	
H \ W	60~100	~130	~160	~190	~240	~290	~330
80~100	12,600	17,000	20,400	25,600	28,700	36,800	43,400
~120	13,500	18,200	22,300	28,000	31,300	40,100	46,700
~140	14,400	19,400	23,800	29,900	33,500	43,000	50,700
~160	15,300	20,600	25,600	31,500	35,500	45,400	54,300
~180	16,200	21,800	27,400	33,400	37,700	48,300	58,200
~200	17,100	23,000	29,200	35,300	40,000	51,200	62,200

H \ W	60~100	~130	~160	~190	~240	~290	~330
80~100	12,000	16,100	19,400	24,300	27,400	35,100	41,400
~120	12,900	17,300	21,300	26,700	30,000	38,400	44,600
~140	13,800	18,500	22,800	28,600	32,300	41,300	48,600
~160	14,700	19,700	24,700	30,500	34,200	43,700	52,200
~180	15,600	20,900	26,600	32,400	36,100	46,600	56,200
~200	16,500	22,100	28,500	34,300	38,000	49,500	60,200

style no.60 プレーンシェード														
		コード式					ドラム式							
H	W	30~45	~90	~140	~190	~240	30~45	~90	~140	~190	~240	~290	~340	~390
50~100		11,200	15,300	19,800	25,000	29,700	14,200	18,300	22,800	28,000	32,700	39,800	45,700	50,500
	~140	12,400	16,600	21,300	27,000	31,900	15,400	19,600	24,300	30,000	34,900	42,300	48,600	53,500
	~180	13,600	17,800	22,800	28,900	34,000	16,600	20,800	25,800	31,900	37,000	44,500	51,300	56,300
	~220	14,800	19,200	24,400	30,800	36,200	17,800	22,200	27,400	33,800	39,200	46,900	54,200	59,300
	~260	16,000	20,400	25,900	32,800	38,300	19,000	23,400	28,900	35,800	41,300	49,100	57,100	62,100
	~300	17,200	21,800	27,400	34,700	40,500	20,200	24,800	30,400	37,700	43,500	51,500	59,800	65,100

※ドラム式：仕上り巾39cm以下の場合、仕上り丈は200cmまでとなります。

スリムシェード		コード式	
H	W		
50~100		18~30	
	~140	16,100	
	~180	17,900	
	~220	19,200	
	~240	21,100	
	~240	22,200	

style no.50 バルーンブレード														
		コード式					ドラム式							
スワッグ数		1S	2S	3S	4S	5S	1S	2S	3S	4S	5S	6S	7S	8S
H	W	36~50	~100	~150	~200	~250	40~50	~100	~150	~200	~250	~300	~350	~400
100~140		18,500	28,000	38,400	48,800	61,000	21,500	31,000	41,400	51,800	64,000	74,900	87,000	99,200
	~180	20,800	31,500	43,100	54,800	68,400	23,800	34,500	46,100	57,800	71,400	83,300	97,000	110,700
	~220	23,200	34,900	47,800	60,700	75,900	26,200	37,900	50,800	63,700	78,900	91,700	106,900	122,100
	~260	24,800	38,400	52,500	66,600	83,400	27,800	41,400	55,500	69,600	86,400	100,200	116,900	129,600
	~300	28,000	41,900	57,200	72,600	90,800	31,000	44,900	60,200	75,600	93,800	108,600	126,800	145,000

※出窓の場合はコーナー1ヶ所につきコード式は3,500円、ドラム式は4,500円プラスになります。

style no.51 バルーンフリル														
		コード式					ドラム式							
スワッグ数		1S	2S	3S	4S	5S	1S	2S	3S	4S	5S	6S	7S	8S
H	W	36~50	~100	~150	~200	~250	40~50	~100	~150	~200	~250	~300	~350	~400
100~140		19,000	29,100	40,000	50,900	63,600	22,000	32,100	43,000	53,900	66,600	78,000	90,600	103,300
	~180	21,300	32,600	44,700	56,900	71,000	24,300	35,600	47,700	59,900	74,000	86,400	100,600	114,800
	~220	23,700	36,000	49,400	62,800	78,500	26,700	39,000	52,400	65,800	81,500	94,900	110,500	126,200
	~260	25,300	39,500	54,100	68,700	86,000	28,300	42,500	57,100	71,700	89,000	103,300	120,500	133,700
	~300	28,500	43,000	58,800	74,700	93,400	31,500	46,000	61,800	77,700	96,400	111,700	130,500	149,200

※出窓の場合はコーナー1ヶ所につきコード式は3,500円、ドラム式は4,500円プラスになります。

TM-54400

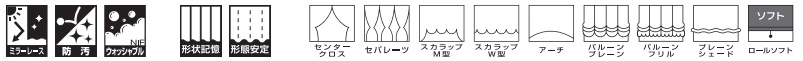

巾 ◇ 150cm 価格 ◇ 1,050円/㎡

リピート ◇ タテ cm ヨコ cm
寸法変化率 ◇ 水洗い/タテ 0.0% ヨコ -0.3%
ドライ/タテ -0.3% ヨコ -0.7%

取扱い表示 ◇ リ-30
防炎性能 ◇ -
Made in Japan

H \ W	~67 1巾(片開き)	~150 2巾	~225 3巾	~300 4巾	~375 5巾	~450 6巾	~525 7巾	~600 8巾
~100	4,000	8,000	12,000	16,000	20,000	24,000	28,000	32,000
~120	4,600	9,200	13,700	18,300	22,800	27,400	32,000	36,500
~140	5,200	10,300	15,400	20,600	25,700	30,800	36,000	41,100
~160	5,700	11,400	17,100	22,800	28,500	34,200	39,900	45,600
~180	6,300	12,600	18,900	25,100	31,400	37,700	43,900	50,200
~200	6,900	13,700	20,600	27,400	34,200	41,100	47,900	54,800
~220	7,500	14,900	22,300	29,700	37,100	44,500	51,900	59,300
~240	8,000	16,000	24,000	32,000	39,900	47,900	55,900	63,900
~260	8,600	17,100	25,700	34,200	42,800	51,300	59,900	68,400
~280	9,200	18,300	27,400	36,500	45,600	54,800	63,900	73,000
約1.5倍ヒダ	~88	~200	~300	~400	~500	~600	~700	~800
フラット約1倍ヒダ	~130	~260	~410	~560				

H \ W	~67 1巾(片開き)	~150 2巾	~225 3巾	~300 4巾	~375 5巾	~450 6巾	~525 7巾	~600 8巾
~100	4,500	8,900	13,300	17,700	22,100	26,500	30,900	35,300
~120	5,100	10,100	15,200	20,200	25,200	30,300	35,300	40,300
~140	5,700	11,400	17,100	22,700	28,400	34,100	39,700	45,000
~160	6,300	12,600	18,900	25,200	31,500	37,800	44,100	50,400
~180	7,000	13,900	20,800	27,800	34,700	41,600	48,600	55,500
~200	7,600	15,200	22,700	30,300	37,800	45,400	53,000	60,600
~220	8,200	16,400	24,600	32,800	41,000	49,200	57,400	65,800
~240	8,900	17,700	26,500	35,300	44,100	53,000	61,800	70,200
~260	9,500	18,900	28,400	37,800	47,300	56,700	66,200	75,600
~280	10,100	20,200	30,300	40,400	50,400	60,500	70,600	81,000
約1.5倍ヒダ	~88	~200	~300	~400	~500			

H \ W	~67 1巾(片開き)	~150 2巾	~225 3巾	~300 4巾	~375 5巾	~450 6巾	~525 7巾	~600 8巾
~100	4,900	9,700	14,500	19,400	24,200	29,000	33,900	38,700
~120	5,600	11,100	16,600	22,100	27,600	33,200	38,700	43,500
~140	6,300	12,500	18,700	24,900	31,100	37,300	43,500	49,300
~160	6,900	13,800	20,700	27,600	34,500	41,400	48,300	55,200
~180	7,600	15,200	22,800	30,400	38,000	45,600	53,200	60,600
~200	8,300	16,600	24,900	33,200	41,400	49,700	58,000	66,600
~220	9,000	18,000	27,000	35,900	44,900	53,900	62,800	71,400
~240	9,700	19,400	29,000	38,700	48,300	58,000	67,700	77,200
~260	10,400	20,700	31,100	41,400	51,800	62,100	72,500	83,000
~280	11,100	22,100	33,200	44,200	55,200	66,300	77,300	89,000
約1.5倍ヒダ	~88	~200	~300	~400	~500			

H \ W	~67 1巾(片開き)	~150 2巾	~225 3巾	~300 4巾	~375 5巾	~450 6巾	~525 7巾	~600 8巾
~100	5,700	11,400	17,100	22,700	28,400	34,100	39,700	45,400
~120	6,500	13,000	19,500	26,000	32,400	38,900	45,400	51,900
~140	7,300	14,600	21,900	29,200	36,500	43,800	51,100	58,400
~160	8,100	16,200	24,300	32,400	40,500	48,600	56,700	64,800
~180	9,000	17,900	26,800	35,700	44,600	53,500	62,400	71,300
~200	9,800	19,500	29,200	38,900	48,600	58,400	68,100	77,800
~220	10,600	21,100	31,600	42,200	52,700	63,200	73,800	84,300
~240	11,400	22,700	34,100	45,400	56,700	68,100	79,400	90,800
~260	12,200	24,300	36,500	48,600	60,800	72,900	85,100	97,200

H \ W	~80	~120	~160	~200	~240	~280	~320
~100	8,300	9,600					
~120	9,200	11,000	15,200				
~140	10,000	12,300	17,000	21,700			
~160	10,700	13,500	18,800	23,900	26,300		
~180	11,800	14,800	20,600	26,100	28,800	35,600	
~200	12,800	16,100	22,300	27,900	32,300	38,700	45,300
~220	13,800	17,300	24,200	30,200	33,800	41,800	48,000
~240	14,900	18,700	25,900	32,400	36,300	44,900	51,500
~260	15,900	21,200	27,800	34,600	38,800	47,900	53,600

H \ W	~80	~120	~160	~200	~240	~280	~320
~100	13,200	15,000					
~120	14,400	16,600	22,900				
~140	15,500	18,200	25,000	31,500			
~160	16,500	19,800	27,200	34,100	36,900		
~180	17,900	21,500	29,300	36,600	39,700	48,900	
~200	19,300	23,100	31,400	38,800	43,600	52,300	60,800
~220	20,600	24,600	33,600	41,400	45,400	55,700	63,800
~240	22,000	26,300	35,700	43,900	48,200	59,200	67,700
~260	23,300	29,200	37,800	46,500	51,000	62,600	70,100

H \ W	~40(1P)	~50(1P)	~60(1P)
~100	9,900	11,200	12,300
~120	11,100	12,400	13,500
~140	12,300	13,600	14,800
~160	13,600	14,800	16,000
~180	14,700	16,000	17,200
~200	16,100	17,200	18,400
~220	17,100	18,300	19,600
~240	18,300	19,300	20,300
~260	19,600	20,500	21,200

ウェーブ数	3W	4W	5W	6W	7W	
H \ W	100-130	~160	~190	~240	~290	~330
80-100	12,500	15,600	19,200	22,300	28,400	33,300
~120	13,600	17,500	21,600	24,900	31,700	36,600
~140	14,900	19,000	23,500	27,200	34,600	40,600
~160	16,100	20,100	25,100	29,100	37,000	44,200
~180	17,300	21,600	27,000	31,400	39,900	48,200
~200	18,500	23,100	28,900	33,600	42,800	52,200

ウェーブ数	3W	4W	5W	6W	7W	
H \ W	100-130	~160	~190	~240	~290	~330
80-100	17,000	20,400	25,600	28,700	36,800	43,400
~120	18,200	22,300	28,000	31,300	40,100	46,700
~140	19,400	23,800	29,900	33,500	43,000	50,700
~160	20,600	24,900	31,500	35,500	45,400	54,300
~180	21,800	26,400	33,400	37,700	48,300	58,200
~200	23,000	28,300	35,300	40,000	51,200	62,200

ウェーブ数	2W	3W	4W	5W	6W	7W	
H \ W	60-100	~130	~160	~190	~240	~290	~330
80-100	9,600	12,500	15,600	19,200	22,300	28,400	33,300
~120	10,500	13,600	17,500	21,600	24,900	31,700	36,600
~140	11,400	14,900	19,000	23,500	27,200	34,600	40,600
~160	12,300	16,100	20,100	25,100	29,100	37,000	44,200
~180	13,200	17,300	21,600	27,000	31,400	39,900	48,200
~200	14,100	18,500	23,100	28,900	33,600	42,800	52,200

ウェーブ数	2W	3W	4W	5W	6W	7W	
H \ W	60-100	~130	~160	~190	~240	~290	~330
80-100	12,600	17,000	20,400	25,600	28,700	36,800	43,400
~120	13,500	18,200	22,300	28,000	31,300	40,100	46,700
~140	14,400	19,400	23,800	29,900	33,500	43,000	50,700
~160	15,300	20,600	24,900	31,500	35,500	45,400	54,300
~180	16,200	21,800	26,400	33,400	37,700	48,300	58,200
~200	17,100	23,000	28,300	35,300	40,000	51,200	62,200

H \ W	60-100	~130	~160	~190	~240	~290	~330
80-100	9,400	12,200	15,300	18,900	22,000	28,000	32,800
~120	10,300	13,400	17,200	21,200	24,500	31,300	36,100
~140	11,200	14,600	18,800	23,200	26,800	34,200	40,100
~160	12,100	15,800	20,400	25,100	29,100	37,000	44,200
~180	13,000	17,100	22,100	27,000	31,400	39,900	48,200
~200	13,900	18,300	23,900	29,100	33,600	42,800	52,200

H \ W	60-100	~130	~160	~190	~240	~290	~330
80-100	12,000	16,100	19,400	24,300	27,400	35,100	41,400
~120	12,900	17,300	21,300	26,700	30,000	38,400	44,600
~140	13,800	18,500	22,800	28,600	32,300	41,300	48,600
~160	14,700	19,700	24,700	30,500	34,200	43,700	52,200
~180	15,600	20,900	26,600	32,400	36,100	46,600	56,200
~200	16,500	22,100	28,500	34,300	38,000	49,500	60,200

style no.60 プレーンシェード														
		コード式					ドラム式							
H	W	30~45	~90	~140	~190	~240	30~45	~90	~140	~190	~240	~290	~340	~390
50~100		11,200	15,300	19,800	25,000	29,700	14,200	18,300	22,800	28,000	32,700	39,800	45,700	50,500
	~140	12,400	16,600	21,300	27,000	31,900	15,400	19,600	24,300	30,000	34,900	42,300	48,600	53,500
	~180	13,600	17,800	22,800	28,900	34,000	16,600	20,800	25,800	31,900	37,000	44,500	51,300	56,300
	~220	14,800	19,200	24,400	30,800	36,200	17,800	22,200	27,400	33,800	39,200	46,900	54,200	59,300
	~260	16,000	20,400	25,900	32,800	38,300	19,000	23,400	28,900	35,800	41,300	49,100	57,100	62,100
	~300	17,200	21,800	27,400	34,700	40,500	20,200	24,800	30,400	37,000	43,500	51,500	59,800	65,100

※ドラム式：仕上り巾39cm以下の場合、仕上り丈は200cmまでとなります。

スリムシェード	
コード式	
H	W
50~100	18~30
	16,100
	~140
	17,900
	~180
	19,200
	~220
	21,100
	~240
	22,200

style no.50 バルーンプレーン														
		コード式					ドラム式							
スワッグ数		1S	2S	3S	4S	5S	1S	2S	3S	4S	5S	6S	7S	8S
H	W	36~50	~100	~150	~200	~250	40~50	~100	~150	~200	~250	~300	~350	~400
100~140		18,500	28,000	38,400	48,800	61,000	21,500	31,000	41,400	51,800	64,000	74,900	87,000	99,200
	~180	20,800	31,500	43,100	54,800	68,400	23,800	34,500	46,100	57,800	71,400	83,300	97,000	110,700
	~220	23,200	34,900	47,800	60,700	75,900	26,200	37,900	50,800	63,700	78,900	91,700	106,900	122,100
	~260	24,800	38,400	52,500	66,600	83,400	27,800	41,400	55,500	69,600	86,400	100,200	116,900	129,600
	~300	28,000	41,900	57,200	72,600	90,800	31,000	44,900	60,200	75,600	93,800	108,600	126,800	145,000

※出窓の場合はコーナー1ヶ所につきコード式は3,500円、ドラム式は4,500円プラスになります。

style no.51 バルーンフリル														
		コード式					ドラム式							
スワッグ数		1S	2S	3S	4S	5S	1S	2S	3S	4S	5S	6S	7S	8S
H	W	36~50	~100	~150	~200	~250	40~50	~100	~150	~200	~250	~300	~350	~400
100~140		19,000	29,100	40,000	50,900	63,600	22,000	32,100	43,000	53,900	66,600	78,000	90,600	103,300
	~180	21,300	32,600	44,700	56,900	71,000	24,300	35,600	47,700	59,900	74,000	86,400	100,600	114,800
	~220	23,700	36,000	49,400	62,800	78,500	26,700	39,000	52,400	65,800	81,500	94,900	110,500	126,200
	~260	25,300	39,500	54,100	68,700	86,000	28,300	42,500	57,100	71,700	89,000	103,300	120,500	133,700
	~300	28,500	43,000	58,800	74,700	93,400	31,500	46,000	61,800	77,700	96,400	111,700	130,500	149,200

※出窓の場合はコーナー1ヶ所につきコード式は3,500円、ドラム式は4,500円プラスになります。

style no.S01 ロールソフト						
スプリング・チェーンタイプ						
H	W	30~60	~80	~100	~120	~140
50~80		26,900	29,400	31,400	32,600	34,300
	~120	28,300	31,400	33,400	34,500	36,400
	~160	29,700	33,500	35,500	36,700	38,000
	~200	32,300	35,300	37,500	38,700	40,000
	~240		37,200	39,500	40,700	42,100

※丈は巾の3倍までが限度です。

TM-54401



巾 ◇ 150cm 価格 ◇ 1,050円/㎡
組成 ◇ ポリエステル100%

リポート ◇ タテ cm ヨコ 13.7cm
寸法変化率 ◇ 水洗い/タテ -0.5% ヨコ 0.0%
ドライ/タテ -0.5% ヨコ -1.0%

取扱い表示 ◇ リ-30
防炎性能 ◇ -
Made in Japan

H \ W	~67 1巾(片開き)	~150 2巾	~225 3巾	~300 4巾	~375 5巾	~450 6巾	~525 7巾	~600 8巾
~100	4,000	8,000	12,000	16,000	20,000	24,000	28,000	32,000
~120	4,600	9,200	13,700	18,300	22,800	27,400	32,000	36,500
~140	5,200	10,300	15,400	20,600	25,700	30,800	36,000	41,100
~160	5,700	11,400	17,100	22,800	28,500	34,200	39,900	45,600
~180	6,300	12,600	18,900	25,100	31,400	37,700	43,900	50,200
~200	6,900	13,700	20,600	27,400	34,200	41,100	47,900	54,800
~220	7,500	14,900	22,300	29,700	37,100	44,500	51,900	59,300
~240	8,000	16,000	24,000	32,000	39,900	47,900	55,900	63,900
~260	8,600	17,100	25,700	34,200	42,800	51,300	59,900	68,400
~280	9,200	18,300	27,400	36,500	45,600	54,800	63,900	73,000
約1.5倍ヒダ	~88	~200	~300	~400	~500	~600	~700	~800
フラット約1倍ヒダ	~130	~260	~410	~560				

H \ W	~67 1巾(片開き)	~150 2巾	~225 3巾	~300 4巾	~375 5巾	~450 6巾	~525 7巾
~100	4,500	8,900	13,300	17,700	22,100	26,500	30,900
~120	5,100	10,100	15,200	20,200	25,200	30,300	35,300
~140	5,700	11,400	17,100	22,700	28,400	34,100	39,700
~160	6,300	12,600	18,900	25,200	31,500	37,800	44,100
~180	7,000	13,900	20,800	27,800	34,700	41,600	48,600
~200	7,600	15,200	22,700	30,300	37,800	45,400	53,000
~220	8,200	16,400	24,600	32,800	41,000	49,200	57,400
~240	8,900	17,700	26,500	35,300	44,100	53,000	61,800
~260	9,500	18,900	28,400	37,800	47,300	56,700	66,200
~280	10,100	20,200	30,300	40,400	50,400	60,500	70,600
約1.5倍ヒダ	~88	~200	~300	~400	~500		

H \ W	~67 1巾(片開き)	~150 2巾	~225 3巾	~300 4巾	~375 5巾	~450 6巾	~525 7巾
~100	4,900	9,700	14,500	19,400	24,200	29,000	33,900
~120	5,600	11,100	16,600	22,100	27,600	33,200	38,700
~140	6,300	12,500	18,700	24,900	31,100	37,300	43,500
~160	6,900	13,800	20,700	27,600	34,500	41,400	48,300
~180	7,600	15,200	22,800	30,400	38,000	45,600	53,200
~200	8,300	16,600	24,900	33,200	41,400	49,700	58,000
~220	9,000	18,000	27,000	35,900	44,900	53,900	62,800
~240	9,700	19,400	29,000	38,700	48,300	58,000	67,700
~260	10,400	20,700	31,100	41,400	51,800	62,100	72,500
~280	11,100	22,100	33,200	44,200	55,200	66,300	77,300
約1.5倍ヒダ	~88	~200	~300	~400	~500		

H \ W	~67 1巾(片開き)	~150 2巾	~225 3巾	~300 4巾	~375 5巾	~450 6巾	~525 7巾	~600 8巾
~100	5,700	11,400	17,100	22,700	28,400	34,100	39,700	45,400
~120	6,500	13,000	19,500	26,000	32,400	38,900	45,400	51,900
~140	7,300	14,600	21,900	29,200	36,500	43,800	51,100	58,400
~160	8,100	16,200	24,300	32,400	40,500	48,600	56,700	64,800
~180	9,000	17,900	26,800	35,700	44,600	53,500	62,400	71,300
~200	9,800	19,500	29,200	38,900	48,600	58,400	68,100	77,800
~220	10,600	21,100	31,600	42,200	52,700	63,200	73,800	84,300
~240	11,400	22,700	34,100	45,400	56,700	68,100	79,400	90,800
~260	12,200	24,300	36,500	48,600	60,800	72,900	85,100	97,200

H \ W	~80	~120	~160	~200	~240	~280	~320
~100	8,300	9,600					
~120	9,200	11,000	15,200				
~140	10,000	12,300	17,000	21,700			
~160	10,700	13,500	18,800	23,900	26,300		
~180	11,800	14,800	20,600	26,100	28,800	35,600	
~200	12,800	16,100	22,300	27,900	32,300	38,700	45,300
~220	13,800	17,300	24,200	30,200	33,800	41,800	48,000
~240	14,900	18,700	25,900	32,400	36,300	44,900	51,500
~260	15,900	21,200	27,800	34,600	38,800	47,900	53,600

H \ W	~80	~120	~160	~200	~240	~280	~320
~100	13,200	15,000					
~120	14,400	16,600	22,900				
~140	15,500	18,200	25,000	31,500			
~160	16,500	19,800	27,200	34,100	36,900		
~180	17,900	21,500	29,300	36,600	39,700	48,900	
~200	19,300	23,100	31,400	38,800	43,600	52,300	60,800
~220	20,600	24,600	33,600	41,400	45,400	55,700	63,800
~240	22,000	26,300	35,700	43,900	48,200	59,200	67,700
~260	23,300	29,200	37,800	46,500	51,000	62,600	70,100

H \ W	~40(1P)	~50(1P)	~60(1P)
~100	9,900	11,200	12,300
~120	11,100	12,400	13,500
~140	12,300	13,600	14,800
~160	13,600	14,800	16,000
~180	14,700	16,000	17,200
~200	16,100	17,200	18,400
~220	17,100	18,300	19,600
~240	18,300	19,300	20,300
~260	19,600	20,500	21,200

ウェーブ数	3W	4W	5W	6W	7W	
H \ W	100~130	~160	~190	~240	~290	~330
80~100	12,500	15,600	19,200	22,300	28,400	33,300
~120	13,600	17,500	21,600	24,900	31,700	36,600
~140	14,900	19,000	23,500	27,200	34,600	40,600
~160	16,100	20,100	25,100	29,100	37,000	44,200
~180	17,300	21,600	27,000	31,400	39,900	48,200
~200	18,500	23,100	28,900	33,600	42,800	52,200

ウェーブ数	3W	4W	5W	6W	7W	
H \ W	100~130	~160	~190	~240	~290	~330
80~100	17,000	20,400	25,600	28,700	36,800	43,400
~120	18,200	22,300	28,000	31,300	40,100	46,700
~140	19,400	23,800	29,900	33,500	43,000	50,700
~160	20,600	24,900	31,500	35,500	45,400	54,300
~180	21,800	26,400	33,400	37,700	48,300	58,200
~200	23,000	28,300	35,300	40,000	51,200	62,200

ウェーブ数	2W	3W	4W	5W	6W	7W	
H \ W	60~100	~130	~160	~190	~240	~290	~330
80~100	9,600	12,500	15,600	19,200	22,300	28,400	33,300
~120	10,500	13,600	17,500	21,600	24,900	31,700	36,600
~140	11,400	14,900	19,000	23,500	27,200	34,600	40,600
~160	12,300	16,100	20,100	25,100	29,100	37,000	44,200
~180	13,200	17,300	21,600	27,000	31,400	39,900	48,200
~200	14,100	18,500	23,100	28,900	33,600	42,800	52,200

ウェーブ数	2W	3W	4W	5W	6W	7W	
H \ W	60~100	~130	~160	~190	~240	~290	~330
80~100	12,600	17,000	20,400	25,600	28,700	36,800	43,400
~120	13,500	18,200	22,300	28,000	31,300	40,100	46,700
~140	14,400	19,400	23,800	29,900	33,500	43,000	50,700
~160	15,300	20,600	24,900	31,500	35,500	45,400	54,300
~180	16,200	21,800	26,400	33,400	37,700	48,300	58,200
~200	17,100	23,000	28,300	35,300	40,000	51,200	62,200

H \ W	60~100	~130	~160	~190	~240	~290	~330
80~100	9,400	12,200	15,300	18,900	22,000	28,000	32,800
~120	10,300	13,400	17,200	21,200	24,500	31,300	36,100
~140	11,200	14,600	18,800	23,200	26,800	34,200	40,100
~160	12,100	15,800	20,100	24,700	28,800	36,600	43,700
~180	13,000	17,000	21,600	26,700	31,000	39,500	47,600
~200	13,900	18,200	23,100	28,600	33,300	42,400	51,600

H \ W	60~100	~130	~160	~190	~240	~290	~330
80~100	12,000	16,100	19,400	24,300	27,400	35,100	41,400
~120	12,900	17,300	21,300	26,700	30,000	38,400	46,600
~140	13,800	18,500	22,800	28,600	32,300	41,300	48,600
~160	14,700	19,700	24,300	30,200	34,200	43,700	52,200
~180	15,600	20,900	26,000	32,100	36,400	46,600	56,200
~200	16,500	22,100	27,800	34,000	38,700	49,500	60,200

style no.60 プレーンシェード														
コード式					ドラム式									
H	W	30~45	~90	~140	~190	~240	30~45	~90	~140	~190	~240	~290	~340	~390
50~100		11,200	15,300	19,800	25,000	29,700	14,200	18,300	22,800	28,000	32,700	39,800	45,700	50,500
	~140	12,400	16,600	21,300	27,000	31,900	15,400	19,600	24,300	30,000	34,900	42,300	48,600	53,500
	~180	13,600	17,800	22,800	28,900	34,000	16,600	20,800	25,800	31,900	37,000	44,500	51,300	56,300
	~220	14,800	19,200	24,400	30,800	36,200	17,800	22,200	27,400	33,800	39,200	46,900	54,200	59,300
	~260	16,000	20,400	25,900	32,800	38,300	19,000	23,400	28,900	35,800	41,300	49,100	57,100	62,100
	~300	17,200	21,800	27,400	34,700	40,500	20,200	24,800	30,400	37,700	43,500	51,500	59,800	65,100

※ドラム式：仕上り巾39cm以下の場合、仕上り丈は200cmまでとなります。

スリムシェード	
コード式	
H	W
50~100	18~30
	16,100
	~140
	17,900
	~180
	19,200
	~220
	21,100
	~240
	22,200

style no.63 シャープシェード														
コード式					ドラム式									
H	W	30~45	~90	~140	~190	~240	30~45	~90	~140	~190	~240	~290	~340	~390
50~100		13,900	20,100	26,700	34,500	40,900	16,900	23,100	29,700	37,500	43,900	52,000	59,700	66,300
	~140	15,300	22,000	29,100	37,700	44,600	18,300	25,000	32,100	40,700	47,600	56,200	64,600	71,400
	~180	16,700	23,800	31,400	40,800	48,400	19,700	26,800	34,400	43,800	51,400	60,300	69,700	77,000
	~220	18,100	25,700	33,700	44,000	52,100	21,100	28,700	36,700	47,000	55,100	64,400	74,300	82,000
	~260	19,600	27,800	36,400	47,700	56,600	22,600	30,800	39,400	50,700	59,600	69,300	80,100	88,300
	~300	21,200	29,900	39,200	51,400	61,000	24,200	32,900	42,200	54,400	64,000	74,300	85,900	94,600

※ドラム式：仕上り巾39cm以下の場合、仕上り丈は200cmまでとなります。

style no.50 バルーンブレン														
コード式					ドラム式									
スワッグ数		1S	2S	3S	4S	5S	1S	2S	3S	4S	5S	6S	7S	8S
H	W	36~50	~100	~150	~200	~250	40~50	~100	~150	~200	~250	~300	~350	~400
100~140		18,500	28,000	38,400	48,800	61,000	21,500	31,000	41,400	51,800	64,000	74,900	87,000	99,200
	~180	20,800	31,500	43,100	54,800	68,400	23,800	34,500	46,100	57,800	71,400	83,300	97,000	110,700
	~220	23,200	34,900	47,800	60,700	75,900	26,200	37,900	50,800	63,700	78,900	91,700	106,900	122,100
	~260	24,800	38,400	52,500	66,600	83,400	27,800	41,400	55,500	69,600	86,400	100,200	116,900	129,600
	~300	28,000	41,900	57,200	72,600	90,800	31,000	44,900	60,200	75,600	93,800	108,600	126,800	145,000

※出窓の場合はコーナー1ヶ所につきコード式は3,500円、ドラム式は4,500円プラスになります。

style no.51 バルーンフリル														
コード式					ドラム式									
スワッグ数		1S	2S	3S	4S	5S	1S	2S	3S	4S	5S	6S	7S	8S
H	W	36~50	~100	~150	~200	~250	40~50	~100	~150	~200	~250	~300	~350	~400
100~140		19,000	29,100	40,000	50,900	63,600	22,000	32,100	43,000	53,900	66,600	78,000	90,600	103,300
	~180	21,300	32,600	44,700	56,900	71,000	24,300	35,600	47,700	59,900	74,000	86,400	100,600	114,800
	~220	23,700	36,000	49,400	62,800	78,500	26,700	39,000	52,400	65,800	81,500	94,900	110,500	126,200
	~260	25,300	39,500	54,100	68,700	86,000	28,300	42,500	57,100	71,700	89,000	103,300	120,500	133,700
	~300	28,500	43,000	58,800	74,700	93,400	31,500	46,000	61,800	77,700	96,400	111,700	130,500	149,200

※出窓の場合はコーナー1ヶ所につきコード式は3,500円、ドラム式は4,500円プラスになります。

style no.S01 ロールソフト						
スプリング・チェーンタイプ						
H	W	30~60	~80	~100	~120	~140
50~80		26,900	29,400	31,400	32,600	34,300
	~120	28,300	31,400	33,400	34,500	36,400
	~160	29,700	33,500	35,500	36,700	38,000
	~200	32,300	35,300	37,500	38,700	40,000
	~240		37,200	39,500	40,700	42,100

※丈は巾の3倍までが限度です。

TM-54402・54403

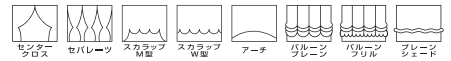

巾 ◇ 150cm 価格 ◇ 1,050円/㎡
組成 ◇ ポリエステル100%

リポート ◇ タテ cm ヨコ cm
寸法変化率 ◇ 水洗い/タテ 0.0% ヨコ 0.5%
ドライ/タテ -0.8% ヨコ -0.8%

取扱い表示 ◇ リ-30 40 50 60 70 80 90 100 110 120 130
防炎性能 ◇ -
Made in Japan

H \ W	~67 1巾(片開き)	~150 2巾	~225 3巾	~300 4巾	~375 5巾	~450 6巾	~525 7巾	~600 8巾
~100	4,000	8,000	12,000	16,000	20,000	24,000	28,000	32,000
~120	4,600	9,200	13,700	18,300	22,800	27,400	32,000	36,500
~140	5,200	10,300	15,400	20,600	25,700	30,800	36,000	41,100
~160	5,700	11,400	17,100	22,800	28,500	34,200	39,900	45,600
~180	6,300	12,600	18,900	25,100	31,400	37,700	43,900	50,200
~200	6,900	13,700	20,600	27,400	34,200	41,100	47,900	54,800
~220	7,500	14,900	22,300	29,700	37,100	44,500	51,900	59,300
~240	8,000	16,000	24,000	32,000	39,900	47,900	55,900	63,900
~260	8,600	17,100	25,700	34,200	42,800	51,300	59,900	68,400
~280	9,200	18,300	27,400	36,500	45,600	54,800	63,900	73,000
約1.5倍ヒダ	~88	~200	~300	~400	~500	~600	~700	~800
フラット約1倍ヒダ	~130	~260	~410	~560				

H \ W	~67 1巾(片開き)	~150 2巾	~225 3巾	~300 4巾	~375 5巾	~450 6巾	~525 7巾	~600 8巾
~100	4,500	8,900	13,300	17,700	22,100	26,500	30,900	35,300
~120	5,100	10,100	15,200	20,200	25,200	30,300	35,300	40,300
~140	5,700	11,400	17,100	22,700	28,400	34,100	39,700	45,000
~160	6,300	12,600	18,900	25,200	31,500	37,800	44,100	50,400
~180	7,000	13,900	20,800	27,800	34,700	41,600	48,600	55,500
~200	7,600	15,200	22,700	30,300	37,800	45,400	53,000	60,600
~220	8,200	16,400	24,600	32,800	41,000	49,200	57,400	65,800
~240	8,900	17,700	26,500	35,300	44,100	53,000	61,800	70,200
~260	9,500	18,900	28,400	37,800	47,300	56,700	66,200	75,600
~280	10,100	20,200	30,300	40,400	50,400	60,500	70,600	81,000
約1.5倍ヒダ	~88	~200	~300	~400	~500			

H \ W	~67 1巾(片開き)	~150 2巾	~225 3巾	~300 4巾	~375 5巾	~450 6巾	~525 7巾	~600 8巾
~100	4,900	9,700	14,500	19,400	24,200	29,000	33,900	38,700
~120	5,600	11,100	16,600	22,100	27,600	33,200	38,700	43,500
~140	6,300	12,500	18,700	24,900	31,100	37,300	43,500	49,500
~160	6,900	13,800	20,700	27,600	34,500	41,400	48,300	55,200
~180	7,600	15,200	22,800	30,400	38,000	45,600	53,200	60,600
~200	8,300	16,600	24,900	33,200	41,400	49,700	58,000	66,600
~220	9,000	18,000	27,000	35,900	44,900	53,900	62,800	71,800
~240	9,700	19,400	29,000	38,700	48,300	58,000	67,700	77,200
~260	10,400	20,700	31,100	41,400	51,800	62,100	72,500	82,200
~280	11,100	22,100	33,200	44,200	55,200	66,300	77,300	88,200
約1.5倍ヒダ	~88	~200	~300	~400	~500			

H \ W	~67 1巾(片開き)	~150 2巾	~225 3巾	~300 4巾	~375 5巾	~450 6巾	~525 7巾	~600 8巾
~100	5,700	11,400	17,100	22,700	28,400	34,100	39,700	45,400
~120	6,500	13,000	19,500	26,000	32,400	38,900	45,400	51,900
~140	7,300	14,600	21,900	29,200	36,500	43,800	51,100	58,400
~160	8,100	16,200	24,300	32,400	40,500	48,600	56,700	64,800
~180	9,000	17,900	26,800	35,700	44,600	53,500	62,400	71,300
~200	9,800	19,500	29,200	38,900	48,600	58,400	68,100	77,800
~220	10,600	21,100	31,600	42,200	52,700	63,200	73,800	84,300
~240	11,400	22,700	34,100	45,400	56,700	68,100	79,400	90,800
~260	12,200	24,300	36,500	48,600	60,800	72,900	85,100	97,200

H \ W	~80	~120	~160	~200	~240	~280	~320
~100	8,300	9,600					
~120	9,200	11,000	15,200				
~140	10,000	12,300	17,000	21,700			
~160	10,700	13,500	18,800	23,900	26,300		
~180	11,800	14,800	20,600	26,100	28,800	35,600	
~200	12,800	16,100	22,300	27,900	32,300	38,700	45,300
~220	13,800	17,300	24,200	30,200	33,800	41,800	48,000
~240	14,900	18,700	25,900	32,400	36,300	44,900	51,500
~260	15,900	21,200	27,800	34,600	38,800	47,900	53,600

H \ W	~40(1P)	~50(1P)	~60(1P)
~100	9,900	11,200	12,300
~120	11,100	12,400	13,500
~140	12,300	13,600	14,800
~160	13,600	14,800	16,000
~180	14,700	16,000	17,200
~200	16,100	17,200	18,400
~220	17,100	18,300	19,600
~240	18,300	19,300	20,300
~260	19,600	20,500	21,200

H \ W	~80	~120	~160	~200	~240	~280	~320
~100	13,200	15,000					
~120	14,400	16,600	22,900				
~140	15,500	18,200	25,000	31,500			
~160	16,500	19,800	27,200	34,100	36,900		
~180	17,900	21,500	29,300	36,600	39,700	48,900	
~200	19,300	23,100	31,400	38,800	43,600	52,300	60,800
~220	20,600	24,600	33,600	41,400	45,400	55,700	63,800
~240	22,000	26,300	35,700	43,900	48,200	59,200	67,700
~260	23,300	29,200	37,800	46,500	51,000	62,600	70,100

ウェーブ数	3W	4W	5W	6W	7W	
H \ W	100~130	~160	~190	~240	~290	~330
80~100	12,500	15,600	19,200	22,300	28,400	33,300
~120	13,600	17,500	21,600	24,900	31,700	36,600
~140	14,900	19,000	23,500	27,200	34,600	40,600
~160	16,100	20,100	25,100	29,100	37,000	44,200
~180	17,300	21,600	27,000	31,400	39,900	48,200
~200	18,500	23,000	28,900	33,600	42,800	52,200

ウェーブ数	2W	3W	4W	5W	6W	7W	
H \ W	60~100	~130	~160	~190	~240	~290	~330
80~100	9,600	12,500	15,600	19,200	22,300	28,400	33,300
~120	10,500	13,600	17,500	21,600	24,900	31,700	36,600
~140	11,400	14,900	19,000	23,500	27,200	34,600	40,600
~160	12,300	16,100	20,100	25,100	29,100	37,000	44,200
~180	13,200	17,300	21,600	27,000	31,400	39,900	48,200
~200	14,100	18,500	23,000	28,900	33,600	42,800	52,200

H \ W	60~100	~130	~160	~190	~240	~290	~330
80~100	9,400	12,200	15,300	18,900	22,000	28,000	32,800
~120	10,300	13,400	17,200	21,200	24,500	31,300	36,100
~140	11,200	14,600	18,800	23,200	26,800	34,200	40,100
~160	12,100	15,800	20,000	24,700	28,800	36,600	43,700
~180	13,000	17,000	21,400	26,700	31,000	39,500	47,600
~200	13,900	18,200	22,800	28,600	33,300	42,400	51,600

ウェーブ数	3W	4W	5W	6W	7W	
H \ W	100~130	~160	~190	~240	~290	~330
80~100	17,000	20,400	25,600	28,700	36,800	43,400
~120	18,200	22,300	28,000	31,300	40,100	46,700
~140	19,400	23,800	29,900	33,500	43,000	50,700
~160	20,600	24,900	31,500	35,500	45,400	54,300
~180	21,800	26,400	33,400	37,700	48,300	58,200
~200	23,000	28,000	35,300	40,000	51,200	62,200

ウェーブ数	2W	3W	4W	5W	6W	7W	
H \ W	60~100	~130	~160	~190	~240	~290	~330
80~100	12,600	17,000	20,400	25,600	28,700	36,800	43,400
~120	13,500	18,200	22,300	28,000	31,300	40,100	46,700
~140	14,400	19,400	23,800	29,900	33,500	43,000	50,700
~160	15,300	20,600	24,900	31,500	35,500	45,400	54,300
~180	16,200	21,800	26,400	33,400	37,700	48,300	58,200
~200	17,100	23,000	28,000	35,300	40,000	51,200	62,200

H \ W	60~100	~130	~160	~190	~240	~290	~330
80~100	12,000	16,100	19,400	24,300	27,400	35,100	41,400
~120	12,900	17,300	21,300	26,700	30,000	38,400	44,600
~140	13,800	18,500	22,800	28,600	32,300	41,300	48,600
~160	14,700	19,700	24,700	30,200	34,200	43,700	52,200
~180	15,600	20,900	26,700	32,100	36,400	46,600	56,200
~200	16,500	22,100	28,600	34,000	38,700	49,500	60,200

style no.60 プレーンシェード														
		コード式					ドラム式							
H	W	30~45	~90	~140	~190	~240	30~45	~90	~140	~190	~240	~290	~340	~390
50~100		11,200	15,300	19,800	25,000	29,700	14,200	18,300	22,800	28,000	32,700	39,800	45,700	50,500
	~140	12,400	16,600	21,300	27,000	31,900	15,400	19,600	24,300	30,000	34,900	42,300	48,600	53,500
	~180	13,600	17,800	22,800	28,900	34,000	16,600	20,800	25,800	31,900	37,000	44,500	51,300	56,300
	~220	14,800	19,200	24,400	30,800	36,200	17,800	22,200	27,400	33,800	39,200	46,900	54,200	59,300
	~260	16,000	20,400	25,900	32,800	38,300	19,000	23,400	28,900	35,800	41,300	49,100	57,100	62,100
	~300	17,200	21,800	27,400	34,700	40,500	20,200	24,800	30,400	37,700	43,500	51,500	59,800	65,100

※ドラム式：仕上り巾39cm以下の場合、仕上り丈は200cmまでとなります。

スリムシェード		コード式	
H	W		
50~100		18~30	
	~140	16,100	
	~180	17,900	
	~220	19,200	
	~240	21,100	
	~240	22,200	

style no.50 バルーンプレーン														
		コード式					ドラム式							
スワッグ数		1S	2S	3S	4S	5S	1S	2S	3S	4S	5S	6S	7S	8S
	36~50	~100	~150	~200	~250		40~50	~100	~150	~200	~250	~300	~350	~400
100~140		18,500	28,000	38,400	48,800	61,000	21,500	31,000	41,400	51,800	64,000	74,900	87,000	99,200
	~180	20,800	31,500	43,100	54,800	68,400	23,800	34,500	46,100	57,800	71,400	83,300	97,000	110,700
	~220	23,200	34,900	47,800	60,700	75,900	26,200	37,900	50,800	63,700	78,900	91,700	106,900	122,100
	~260	24,800	38,400	52,500	66,600	83,400	27,800	41,400	55,500	69,600	86,400	100,200	116,900	129,600
	~300	28,000	41,900	57,200	72,600	90,800	31,000	44,900	60,200	75,600	93,800	108,600	126,800	145,000

※出窓の場合はコーナー1ヶ所につきコード式は3,500円、ドラム式は4,500円プラスになります。

style no.51 バルーンフリル														
		コード式					ドラム式							
スワッグ数		1S	2S	3S	4S	5S	1S	2S	3S	4S	5S	6S	7S	8S
	36~50	~100	~150	~200	~250		40~50	~100	~150	~200	~250	~300	~350	~400
100~140		19,000	29,100	40,000	50,900	63,600	22,000	32,100	43,000	53,900	66,600	78,000	90,600	103,300
	~180	21,300	32,600	44,700	56,900	71,000	24,300	35,600	47,700	59,900	74,000	86,400	100,600	114,800
	~220	23,700	36,000	49,400	62,800	78,500	26,700	39,000	52,400	65,800	81,500	94,900	110,500	126,200
	~260	25,300	39,500	54,100	68,700	86,000	28,300	42,500	57,100	71,700	89,000	103,300	120,500	133,700
	~300	28,500	43,000	58,800	74,700	93,400	31,500	46,000	61,800	77,700	96,400	111,700	130,500	149,200

※出窓の場合はコーナー1ヶ所につきコード式は3,500円、ドラム式は4,500円プラスになります。

TM-54404

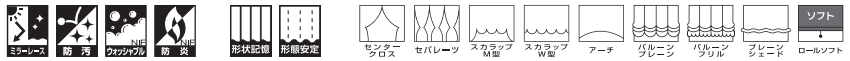

巾 ◇ 100cm 価格 ◇ 900円/m
組成 ◇ ポリエステル100%

リポート ◇ タテcm ヨコcm
寸法変化率 ◇ 水洗い/タテ 0.0% ヨコ -0.2%
ドライ/タテ -0.5% ヨコ 0.0%

取扱い表示 ◇ リ-30
防炎性能 ◇ (イ)
Made in Japan

H \ W	~44 1巾(片開き)	~100 2巾	~150 3巾	~200 4巾	~250 5巾	~300 6巾	~350 7巾	~400 8巾
~100	3,000	5,900	8,900	11,800	14,700	17,700	20,600	23,600
~120	3,400	6,800	10,100	13,500	16,800	20,200	23,600	26,900
~140	3,800	7,600	11,400	15,200	18,900	22,700	26,500	30,300
~160	4,200	8,400	12,600	16,800	21,000	25,200	29,400	33,600
~180	4,700	9,300	13,900	18,500	23,100	27,800	32,400	37,000
~200	5,100	10,100	15,200	20,200	25,200	30,300	35,300	40,400
~220	5,500	11,000	16,400	21,900	27,300	32,800	38,300	43,700
~240	5,900	11,800	17,700	23,600	29,400	35,300	41,200	47,100
~260	6,300	12,600	18,900	25,200	31,500	37,800	44,100	50,400
~280	6,800	13,500	20,200	26,900	33,600	40,400	47,100	53,800
約1.5倍ヒダ	~56	~120	~200	~266	~333	~400	~466	~533
フラット前ヒダ	~80	~160	~260	~360	~460	~560		

H \ W	~44 1巾(片開き)	~100 2巾	~150 3巾	~200 4巾	~250 5巾	~300 6巾	~350 7巾	~400 8巾
~100	3,300	6,500	9,700	12,900	16,100	19,400	22,600	25,800
~120	3,700	7,400	11,100	14,800	18,400	22,100	25,800	29,500
~140	4,200	8,300	12,500	16,600	20,700	24,900	29,000	33,200
~160	4,600	9,200	13,800	18,400	23,000	27,600	32,200	36,800
~180	5,100	10,200	15,200	20,300	25,300	30,400	35,500	40,500
~200	5,600	11,100	16,600	22,100	27,600	33,200	38,700	44,200
~220	6,000	12,000	18,000	24,000	29,900	35,900	41,900	47,900
~240	6,500	12,900	19,400	25,800	32,200	38,700	45,100	51,600
~260	6,900	13,800	20,700	27,600	34,500	41,400	48,300	55,200
~280	7,400	14,800	22,100	29,500	36,800	44,200	51,600	58,900
約1.5倍ヒダ	~56	~120	~200	~266	~333	~400	~466	~533

H \ W	~44 1巾(片開き)	~100 2巾	~150 3巾	~200 4巾	~250 5巾	~300 6巾	~350 7巾	~400 8巾
~100	3,500	7,000	10,500	14,000	17,500	21,000	24,500	28,000
~120	4,000	8,000	12,000	16,000	20,000	24,000	28,000	32,000
~140	4,500	9,000	13,500	18,000	22,500	27,000	31,500	36,000
~160	5,000	10,000	15,000	20,000	25,000	30,000	35,000	40,000
~180	5,500	11,000	16,500	22,000	27,500	33,000	38,500	44,000
~200	6,000	12,000	18,000	24,000	30,000	36,000	42,000	48,000
~220	6,500	13,000	19,500	26,000	32,500	39,000	45,500	52,000
~240	7,000	14,000	21,000	28,000	35,000	42,000	49,000	56,000
~260	7,500	15,000	22,500	30,000	37,500	45,000	52,500	60,000
~280	8,000	16,000	24,000	32,000	40,000	48,000	56,000	64,000
約1.5倍ヒダ	~56	~120	~200	~266	~333	~400	~466	~533

H \ W	~44 1巾(片開き)	~100 2巾	~150 3巾	~200 4巾	~250 5巾	~300 6巾	~350 7巾	~400 8巾
~100	4,100	8,200	12,200	16,300	20,300	24,400	28,500	32,500
~120	4,700	9,300	14,000	18,600	23,200	27,900	32,500	37,200
~140	5,300	10,500	15,700	20,900	26,100	31,400	36,600	41,800
~160	5,800	11,600	17,400	23,200	29,000	34,800	40,600	46,400
~180	6,400	12,800	19,200	25,600	31,900	38,300	44,700	51,100
~200	7,000	14,000	20,900	27,900	34,800	41,800	48,800	55,700
~220	7,600	15,100	22,700	30,200	37,700	45,300	52,800	60,400
~240	8,200	16,300	24,400	32,500	40,600	48,800	56,900	65,000
~260	8,700	17,400	26,100	34,800	43,500	52,200	60,900	69,600

センタークロス

H \ W	~80	~120	~160	~200	~240	~280	~320
~100	8,100	10,400					
~120	8,900	11,900	15,900				
~140	9,700	13,300	17,900	22,300			
~160	10,400	14,600	19,800	24,600	28,500		
~180	11,500	16,100	21,700	27,000	31,300	37,900	
~200	12,500	17,500	23,500	28,800	35,000	41,200	47,500
~220	13,400	18,800	25,500	31,200	36,700	44,400	50,300
~240	14,500	20,300	27,300	33,500	39,400	47,800	54,000
~260	15,500	23,000	29,200	35,700	42,100	51,000	56,300

セパレーツ

H \ W	~40(1P)	~50(1P)	~60(1P)
~100	10,000	12,100	13,300
~120	11,200	13,600	14,800
~140	12,400	14,900	16,200
~160	13,600	16,300	17,500
~180	14,800	17,700	18,900
~200	16,100	19,100	20,300
~220	17,100	20,400	21,600
~240	18,300	21,600	22,600
~260	19,600	22,800	23,600

レースフレンジ style no.12 (タッセル含む)

H \ W	~80	~120	~160	~200	~240	~280	~320
~100	11,900	15,500					
~120	13,000	17,200	22,800				
~140	14,100	18,900	25,000	30,700			
~160	15,100	20,600	27,300	33,400	38,500		
~180	16,500	22,300	29,400	36,000	41,500	49,900	
~200	17,800	24,000	31,600	38,100	45,600	53,500	61,200
~220	19,100	25,700	33,800	40,800	47,600	57,100	64,300
~240	20,400	27,400	36,000	43,400	50,500	60,800	68,400
~260	21,700	30,400	38,200	46,000	53,600	64,400	71,000

スカラップM型

ウェーブ数	3W	4W	5W	6W	7W	
H \ W	100-130	~160	~190	~240	~290	~330
80-100	13,100	16,300	19,700	24,100	31,600	36,200
~120	14,400	18,300	22,100	26,900	35,100	39,800
~140	15,700	19,800	24,100	29,400	38,400	44,100
~160	16,900	21,000	25,700	31,500	41,100	48,000
~180		22,600	27,700	33,900	44,400	52,200
~200			29,600	36,400	47,600	56,600

スカラップW型

ウェーブ数	2W	3W	4W	5W	6W	7W	
H \ W	60-100	~130	~160	~190	~240	~290	~330
80-100	10,400	13,100	16,300	19,700	24,100	31,600	36,200
~120	11,400	14,400	18,300	22,100	26,900	35,100	39,800
~140	12,400	15,700	19,800	24,100	29,400	38,400	44,100
~160		16,900	21,000	25,700	31,500	41,100	48,000
~180			22,600	27,700	33,900	44,400	52,200
~200				29,600	36,400	47,600	56,600

アーチ

H \ W	60-100	~130	~160	~190	~240	~290	~330
80-100	10,200	12,900	16,000	19,300	23,700	31,000	35,500
~120	11,200	14,100	18,000	21,700	26,500	34,500	39,100
~140	12,200	15,400	19,500	23,700	28,900	37,800	43,400
~160		16,700	20,700	25,300	31,100	40,500	47,300
~180			22,300	27,300	33,500	43,800	51,600
~200				29,300	36,000	47,000	55,900

レースフレンジ style no.18

ウェーブ数	3W	4W	5W	6W	7W	
H \ W	100-130	~160	~190	~240	~290	~330
80-100	16,700	20,000	24,400	29,700	39,400	45,100
~120	17,900	22,000	26,800	32,500	43,000	48,700
~140	19,200	23,600	28,700	35,000	46,200	52,900
~160	20,500	24,800	30,400	37,100	49,000	56,800
~180		26,400	32,300	39,600	52,200	61,100
~200			34,300	42,000	55,400	65,400

レースフレンジ style no.20

ウェーブ数	2W	3W	4W	5W	6W	7W	
H \ W	60-100	~130	~160	~190	~240	~290	~330
80-100	13,100	16,700	20,000	24,400	29,700	39,400	45,100
~120	14,100	17,900	22,000	26,800	32,500	43,000	48,700
~140	15,100	19,200	23,600	28,700	35,000	46,200	52,900
~160		20,500	24,800	30,400	37,100	49,000	56,800
~180			26,400	32,300	39,600	52,200	61,100
~200				34,300	42,000	55,400	65,400

レースフレンジ style no.27

H \ W	60-100	~130	~160	~190	~240	~290	~330
80-100	12,500	15,900	19,200	23,300	28,400	37,600	43,000
~120	13,500	17,100	21,100	25,700	31,200	41,200	46,600
~140	14,500	18,400	22,700	27,700	33,700	44,400	50,900
~160		19,700	23,900	29,300	35,800	47,200	54,800
~180			25,500	31,300	38,300	50,400	59,100
~200				33,200	40,700	53,600	63,400

style no.60 プレーンシェード														
		コード式					ドラム式							
H	W	30~45	~90	~140	~190	~240	30~45	~90	~140	~190	~240	~290	~340	~390
50~100		11,000	15,100	20,600	24,700	30,300	14,000	18,100	23,600	27,700	33,300	40,400	46,100	50,900
	~140	12,200	16,400	22,400	26,600	32,700	15,200	19,400	25,400	29,600	35,700	43,100	49,200	54,100
	~180	13,300	17,600	24,100	28,400	35,000	16,300	20,600	27,100	31,400	38,000	45,500	52,100	57,100
	~220	14,500	18,900	25,900	30,200	37,400	17,500	21,900	28,900	33,200	40,400	48,100	55,100	60,200
	~260	15,600	20,100	27,700	32,100	39,700	18,600	23,100	30,700	35,100	42,700	50,500	58,200	63,200
	~300	16,800	21,400	29,400	33,900	42,100	19,800	24,400	32,400	36,900	45,100	53,200	61,000	66,300

※ドラム式：仕上り巾39cm以下の場合、仕上り丈は200cmまでとなります。

スリムシェード		コード式
H	W	18~30
50~100		15,900
	~140	17,700
	~180	19,000
	~220	20,800
	~240	21,900

style no.50 バルーンプレーン														
		コード式					ドラム式							
スワッグ数		1S	2S	3S	4S	5S	1S	2S	3S	4S	5S	6S	7S	8S
H	W	36~50	~100	~150	~200	~250	40~50	~100	~150	~200	~250	~300	~350	~400
100~140		19,400	28,800	39,000	49,200	62,300	22,400	31,800	42,000	52,200	65,300	77,400	89,300	101,300
	~180	22,000	32,400	43,800	55,200	70,100	25,000	35,400	46,800	58,200	73,100	86,500	99,900	113,300
	~220	24,600	36,100	48,700	61,300	77,900	27,600	39,100	51,700	64,300	80,900	95,500	110,400	125,300
	~260	26,500	39,800	53,500	67,300	85,700	29,500	42,800	56,500	70,300	88,700	104,600	120,900	133,300
	~300	29,900	43,400	58,400	73,300	93,500	32,900	46,400	61,400	76,300	96,500	113,600	131,400	149,300

※出窓の場合はコーナー1ヶ所につきコード式は3,500円、ドラム式は4,500円プラスになります。

style no.51 バルーンフリル														
		コード式					ドラム式							
スワッグ数		1S	2S	3S	4S	5S	1S	2S	3S	4S	5S	6S	7S	8S
H	W	36~50	~100	~150	~200	~250	40~50	~100	~150	~200	~250	~300	~350	~400
100~140		20,100	30,100	41,000	51,900	65,600	23,100	33,100	44,000	54,900	68,600	81,300	93,900	106,500
	~180	22,700	33,800	45,800	57,900	73,400	25,700	36,800	48,800	60,900	76,400	90,400	104,500	118,600
	~220	25,400	37,500	50,700	64,000	81,200	28,400	40,500	53,700	67,000	84,200	99,400	115,000	130,500
	~260	27,200	41,100	55,500	70,000	89,000	30,200	44,100	58,500	73,000	92,000	108,500	125,500	138,600
	~300	30,600	44,800	60,400	76,000	96,800	33,600	47,800	63,400	79,000	99,800	117,500	136,100	154,500

※出窓の場合はコーナー1ヶ所につきコード式は3,500円、ドラム式は4,500円プラスになります。

style no.S01 ロールソフト			
スプリング・チェーンタイプ			
H	W	30~60	~90
50~80		26,700	29,200
	~120	28,100	33,200
	~160	29,500	35,300
	~200	32,000	37,200
	~240	36,900	39,200

※丈は巾の3倍までが限度です。

※ロールソフト加工品は非防災品になります。

TM-54405



巾 ◇ 100cm 価格 ◇ 800円/m
組成 ◇ ポリエステル100%

リポート ◇ タテ cm ヨコ 3.3 cm
寸法変化率 ◇ 水洗い/タテ 0.0% ヨコ -0.5%
ドライ/タテ -0.5% ヨコ -0.5%

取扱い表示 ◇ リ-30
防炎性能 ◇ (イ)
Made in Japan

H \ W	~44 1巾(片開き)	~100 2巾	~150 3巾	~200 4巾	~250 5巾	~300 6巾	~350 7巾	~400 8巾
~100	2,800	5,600	8,400	11,200	14,000	16,800	19,600	22,400
~120	3,200	6,400	9,600	12,800	16,000	19,200	22,400	25,600
~140	3,600	7,200	10,800	14,400	18,000	21,600	25,200	28,800
~160	4,000	8,000	12,000	16,000	20,000	24,000	28,000	32,000
~180	4,400	8,800	13,200	17,600	22,000	26,400	30,800	35,200
~200	4,800	9,600	14,400	19,200	24,000	28,800	33,600	38,400
~220	5,200	10,400	15,600	20,800	26,000	31,200	36,400	41,600
~240	5,600	11,200	16,800	22,400	28,000	33,600	39,200	44,800
~260	6,000	12,000	18,000	24,000	30,000	36,000	42,000	48,000
~280	6,400	12,800	19,200	25,600	32,000	38,400	44,800	51,200
約1.5倍ヒダ	~56	~120	~200	~266	~333	~400	~466	~533
フラット前ヒダ	~80	~160	~260	~360	~460	~560		

H \ W	~44 1巾(片開き)	~100 2巾	~150 3巾	~200 4巾	~250 5巾	~300 6巾	~350 7巾	~400 8巾
~100	3,100	6,200	9,300	12,400	15,400	18,500	21,600	24,700
~120	3,600	7,100	10,600	14,100	17,600	21,200	24,700	28,200
~140	4,000	8,000	11,900	15,900	19,800	23,800	27,800	31,700
~160	4,400	8,800	13,200	17,600	22,000	26,400	30,800	35,200
~180	4,900	9,700	14,600	19,400	24,200	29,100	33,900	38,800
~200	5,300	10,600	15,900	21,200	26,400	31,700	37,000	42,300
~220	5,800	11,500	17,200	22,900	28,600	34,400	40,100	45,800
~240	6,200	12,400	18,500	24,700	30,800	37,000	43,200	49,300
~260	6,600	13,200	19,800	26,400	33,000	39,600	46,200	52,800
~280	7,100	14,100	21,200	28,200	35,200	42,300	49,300	56,400
約1.5倍ヒダ	~56	~120	~200	~266	~333	~400	~466	~533

H \ W	~44 1巾(片開き)	~100 2巾	~150 3巾	~200 4巾	~250 5巾	~300 6巾	~350 7巾	~400 8巾
~100	3,400	6,800	10,100	13,500	16,800	20,200	23,600	26,900
~120	3,900	7,700	11,600	15,400	19,200	23,100	26,900	30,800
~140	4,400	8,700	13,000	17,300	21,600	26,000	30,300	34,600
~160	4,800	9,600	14,400	19,200	24,000	28,800	33,600	38,400
~180	5,300	10,600	15,900	21,200	26,400	31,700	37,000	42,300
~200	5,800	11,600	17,300	23,100	28,800	34,600	40,400	46,100
~220	6,300	12,500	18,800	25,000	31,200	37,500	43,700	50,000
~240	6,800	13,500	20,200	26,900	33,600	40,400	47,100	53,800
~260	7,200	14,400	21,600	28,800	36,000	43,200	50,400	57,600
~280	7,700	15,400	23,100	30,800	38,400	46,100	53,800	61,500
約1.5倍ヒダ	~56	~120	~200	~266	~333	~400	~466	~533

H \ W	~44 1巾(片開き)	~100 2巾	~150 3巾	~200 4巾	~250 5巾	~300 6巾	~350 7巾	~400 8巾
~100	4,000	7,900	11,800	15,700	19,600	23,600	27,500	31,400
~120	4,500	9,000	13,500	18,000	22,400	26,900	31,400	35,900
~140	5,100	10,100	15,200	20,200	25,200	30,300	35,300	40,400
~160	5,600	11,200	16,800	22,400	28,000	33,600	39,200	44,800
~180	6,200	12,400	18,500	24,700	30,800	37,000	43,200	49,300
~200	6,800	13,500	20,200	26,900	33,600	40,400	47,100	53,800
~220	7,300	14,600	21,900	29,200	36,400	43,700	51,000	58,300
~240	7,900	15,700	23,600	31,400	39,200	47,100	54,900	62,800
~260	8,400	16,800	25,200	33,600	42,000	50,400	58,800	67,200

センタークロス

H \ W	~80	~120	~160	~200	~240	~280	~320
~100	7,800	10,000					
~120	8,600	11,400	15,300				
~140	9,300	12,800	17,100	21,400			
~160	10,000	14,000	19,000	23,700	27,400		
~180	11,000	15,400	20,800	25,900	30,000	36,400	
~200	12,000	16,800	22,600	27,600	33,700	39,600	45,600
~220	12,900	18,100	24,500	29,900	35,200	42,700	48,300
~240	13,900	19,500	26,200	32,100	37,800	45,900	51,900
~260	14,900	22,100	28,100	34,300	40,400	49,000	54,000

セパレーツ

H \ W	~40(1P)	~50(1P)	~60(1P)
~100	9,700	11,800	13,000
~120	10,900	13,200	14,400
~140	12,100	14,500	15,700
~160	13,300	15,800	17,000
~180	14,400	17,200	18,400
~200	15,800	18,500	19,700
~220	16,700	19,700	21,000
~240	17,900	20,900	21,900
~260	19,200	22,100	22,900

レースフレンジ style no.12 (タッセル含む)

H \ W	~80	~120	~160	~200	~240	~280	~320
~100	11,800	15,200					
~120	12,800	16,900	22,400				
~140	13,900	18,500	24,500	30,100			
~160	14,900	20,200	26,700	32,700	37,600		
~180	16,200	21,900	28,800	35,200	40,600	48,800	
~200	17,400	23,500	30,900	37,300	44,600	52,300	59,700
~220	18,700	25,100	33,100	39,900	46,400	55,800	62,800
~240	20,000	26,800	35,200	42,400	49,300	59,300	66,700
~260	21,300	29,800	37,400	44,900	52,300	62,700	69,100

スカラップM型

ウェーブ数	3W	4W	5W	6W	7W	
H \ W	100~130	~160	~190	~240	~290	~330
80~100	12,600	15,700	18,900	23,200	30,300	34,800
~120	13,700	17,600	21,200	25,900	33,700	38,200
~140	15,000	19,100	23,100	28,300	36,800	42,300
~160	16,200	20,200	24,700	30,300	39,400	46,100
~180	17,400	21,700	26,600	32,600	42,600	50,200
~200		28,500	35,000	45,600	54,400	

スカラップW型

ウェーブ数	2W	3W	4W	5W	6W	7W	
H \ W	60~100	~130	~160	~190	~240	~290	~330
80~100	10,000	12,600	15,700	18,900	23,200	30,300	34,800
~120	10,900	13,700	17,600	21,200	25,900	33,700	38,200
~140	11,900	15,000	19,100	23,100	28,300	36,800	42,300
~160	12,900	16,200	20,200	24,700	30,300	39,400	46,100
~180	13,900	17,400	21,700	26,600	32,600	42,600	50,200
~200		28,500	35,000	45,600	54,400		

アーチ

H \ W	60~100	~130	~160	~190	~240	~290	~330
80~100	9,800	12,300	15,400	18,600	22,800	29,700	34,200
~120	10,800	13,500	17,300	20,900	25,500	33,200	37,600
~140	11,700	14,700	18,800	22,800	27,900	36,300	41,700
~160	12,600	15,900	20,000	24,400	29,900	38,900	45,500
~180	13,500	17,100	21,500	26,300	32,400	42,000	49,600
~200		28,200	34,700	45,100	53,800		

レースフレンジ style no.18

ウェーブ数	3W	4W	5W	6W	7W	
H \ W	100~130	~160	~190	~240	~290	~330
80~100	16,400	19,700	23,900	29,200	38,700	44,200
~120	17,500	21,600	26,200	31,900	42,100	47,700
~140	18,800	23,100	28,100	34,300	45,200	51,800
~160	20,000	24,200	29,700	36,300	47,800	55,500
~180	21,300	25,700	31,600	38,600	51,000	59,700
~200		33,500	41,000	54,000	63,800	

レースフレンジ style no.20

ウェーブ数	2W	3W	4W	5W	6W	7W	
H \ W	60~100	~130	~160	~190	~240	~290	~330
80~100	12,800	16,400	19,700	23,900	29,200	38,700	44,200
~120	13,800	17,500	21,600	26,200	31,900	42,100	47,700
~140	14,800	18,800	23,100	28,100	34,300	45,200	51,800
~160	15,800	20,000	24,200	29,700	36,300	47,800	55,500
~180	16,800	21,300	25,700	31,600	38,600	51,000	59,700
~200		33,500	41,000	54,000	63,800		

レースフレンジ style no.27

H \ W	60~100	~130	~160	~190	~240	~290	~330
80~100	12,200	15,500	18,800	22,900	27,900	36,900	42,200
~120	13,200	16,700	20,700	25,200	30,600	40,300	45,600
~140	14,200	17,900	22,200	27,100	33,000	43,400	49,800
~160	15,200	19,100	23,400	28,600	35,000	46,000	53,500
~180	16,200	20,300	24,900	30,500	37,400	49,100	57,600
~200		32,400	39,700	52,200	61,800		

style no.50 バルーンプレーン													
	コード式					ドラム式							
スワッグ数	1S	2S	3S	4S	5S	1S	2S	3S	4S	5S	6S	7S	8S
H \ W	36~50	~100	~150	~200	~250	40~50	~100	~150	~200	~250	~300	~350	~400
100~140	19,200	28,400	38,500	48,600	61,400	22,200	31,400	41,500	51,600	64,400	76,400	88,200	100,000
~180	21,700	32,000	43,200	54,400	69,000	24,700	35,000	46,200	57,400	72,000	85,200	98,400	111,700
~220	24,300	35,500	47,900	60,300	76,500	27,300	38,500	50,900	63,300	79,500	94,000	108,700	123,400
~260	26,000	39,100	52,600	66,200	84,100	29,000	42,100	55,600	69,200	87,100	102,800	118,900	131,100
~300	29,400	42,700	57,400	72,100	91,700	32,400	45,700	60,400	75,100	94,700	111,500	129,100	146,700

※ 出窓の場合はコーナー1ヶ所につきコード式は3,500円、ドラム式は4,500円プラスになります。

style no.51 バルーンフリル													
	コード式					ドラム式							
スワッグ数	1S	2S	3S	4S	5S	1S	2S	3S	4S	5S	6S	7S	8S
H \ W	36~50	~100	~150	~200	~250	40~50	~100	~150	~200	~250	~300	~350	~400
100~140	19,800	29,600	40,300	50,900	64,400	22,800	32,600	43,300	53,900	67,400	79,900	92,300	104,700
~180	22,300	33,200	45,000	56,800	71,900	25,300	36,200	48,000	59,800	74,900	88,700	102,500	116,400
~220	24,900	36,700	49,700	62,700	79,500	27,900	39,700	52,700	65,700	82,500	97,500	112,800	128,000
~260	26,700	40,300	54,400	68,500	87,100	29,700	43,300	57,400	71,500	90,100	106,300	123,000	135,800
~300	30,100	43,900	59,200	74,400	94,700	33,100	46,900	62,200	77,400	97,700	115,100	133,200	151,400

※ 出窓の場合はコーナー1ヶ所につきコード式は3,500円、ドラム式は4,500円プラスになります。

TM-54406

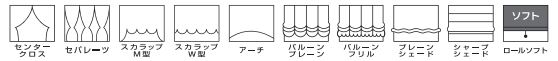

巾 ◇ 100cm 価格 ◇ 750円/m
組成 ◇ ポリエステル100%

リポート ◇ タテ cm ヨコ cm
寸法変化率 ◇ 水洗い/タテ 0.0% ヨコ -0.2%
ドライ/タテ -0.5% ヨコ 0.0%

取扱い表示 ◇ リ-30 40 50 60 70 80 90 100 110 120 130 140 150 160 170 180 190 200 210 220 230 240 250 260 270 280 290 300 310 320 330 340 350 360 370 380 390 400 410 420 430 440 450 460 470 480 490 500 510 520 530 540 550 560 570 580 590 600 610 620 630 640 650 660 670 680 690 700 710 720 730 740 750 760 770 780 790 800 810 820 830 840 850 860 870 880 890 900 910 920 930 940 950 960 970 980 990 1000
防炎性能 ◇ -
Made in Japan

H	W	~44 1巾(片開き)	~100 2巾	~150 3巾	~200 4巾	~250 5巾	~300 6巾	~350 7巾	~400 8巾
~100		2,800	5,500	8,200	11,000	13,700	16,400	19,200	21,900
~120		3,200	6,300	9,400	12,500	15,600	18,800	21,900	25,000
~140		3,600	7,100	10,600	14,100	17,600	21,100	24,600	28,100
~160		3,900	7,800	11,700	15,600	19,500	23,400	27,300	31,200
~180		4,300	8,600	12,900	17,200	21,500	25,800	30,100	34,400
~200		4,700	9,400	14,100	18,800	23,400	28,100	32,800	37,500
~220		5,100	10,200	15,300	20,300	25,400	30,500	35,500	40,600
~240		5,500	11,000	16,400	21,900	27,300	32,800	38,300	43,700
~260		5,900	11,700	17,600	23,400	29,300	35,100	41,000	46,800
~280		6,300	12,500	18,800	25,000	31,200	37,500	43,700	50,000
約1.5倍ヒダ		~56	~120	~200	~266	~333	~400	~466	~533
フラット前1倍ヒダ		~80	~160	~260	~360	~460	~560		

H	W	~44 1巾(片開き)	~100 2巾	~150 3巾	~200 4巾	~250 5巾	~300 6巾	~350 7巾	~400 8巾
~100		3,100	6,100	9,100	12,100	15,100	18,100	21,100	24,100
~120		3,500	6,900	10,400	13,800	17,200	20,700	24,100	27,600
~140		3,900	7,800	11,700	15,500	19,400	23,300	27,100	31,000
~160		4,300	8,600	12,900	17,200	21,500	25,800	30,100	34,400
~180		4,800	9,500	14,200	19,000	23,700	28,400	33,200	37,900
~200		5,200	10,400	15,500	20,700	25,800	31,000	36,200	41,300
~220		5,600	11,200	16,800	22,400	28,000	33,600	39,200	44,800
~240		6,100	12,100	18,100	24,100	30,100	36,200	42,200	48,200
~260		6,500	12,900	19,400	25,800	32,300	38,700	45,200	51,600
~280		6,900	13,800	20,700	27,600	34,400	41,300	48,200	55,100
約1.5倍ヒダ		~56	~120	~200	~266	~333	~400	~466	~533

H	W	~44 1巾(片開き)	~100 2巾	~150 3巾	~200 4巾	~250 5巾	~300 6巾	~350 7巾	~400 8巾
~100		3,300	6,600	9,900	13,200	16,500	19,800	23,100	26,400
~120		3,800	7,600	11,300	15,100	18,800	22,600	26,400	30,100
~140		4,300	8,500	12,700	17,000	21,200	25,400	29,700	33,900
~160		4,700	9,400	14,100	18,800	23,500	28,200	32,900	37,600
~180		5,200	10,400	15,600	20,700	25,900	31,100	36,200	41,400
~200		5,700	11,300	17,000	22,600	28,200	33,900	39,500	45,200
~220		6,200	12,300	18,400	24,500	30,600	36,700	42,800	48,900
~240		6,600	13,200	19,800	26,400	32,900	39,500	46,100	52,700
~260		7,100	14,100	21,200	28,200	35,300	42,300	49,400	56,400
~280		7,600	15,100	22,600	30,100	37,600	45,200	52,700	60,200
約1.5倍ヒダ		~56	~120	~200	~266	~333	~400	~466	~533

H	W	~44 1巾(片開き)	~100 2巾	~150 3巾	~200 4巾	~250 5巾	~300 6巾	~350 7巾	~400 8巾
~100		3,900	7,700	11,600	15,400	19,300	23,100	27,000	30,800
~120		4,400	8,800	13,200	17,600	22,000	26,400	30,800	35,200
~140		5,000	9,900	14,900	19,800	24,800	29,700	34,700	39,600
~160		5,500	11,000	16,500	22,000	27,500	33,000	38,500	44,000
~180		6,100	12,100	18,200	24,200	30,300	36,300	42,400	48,400
~200		6,600	13,200	19,800	26,400	33,000	39,600	46,200	52,800
~220		7,200	14,300	21,500	28,600	35,800	42,900	50,100	57,200
~240		7,700	15,400	23,100	30,800	38,500	46,200	53,900	61,600
~260		8,300	16,500	24,800	33,000	41,300	49,500	57,800	66,000

センタークロス

H	W	~80	~120	~160	~200	~240	~280	~320
~100		7,700	9,800					
~120		8,400	11,100	15,000				
~140		9,100	12,500	16,800	21,000			
~160		9,800	13,700	18,600	23,200	26,900		
~180		10,800	15,100	20,400	25,400	29,400	35,700	
~200		11,700	16,400	22,100	27,100	33,000	38,800	44,700
~220		12,600	17,700	24,000	29,300	34,500	41,800	47,300
~240		13,600	19,100	25,700	31,500	37,000	44,900	50,800
~260		14,600	21,700	27,500	33,600	39,600	48,000	52,900

セバレーツ

H	W	~40(1P)	~50(1P)	~60(1P)
~100		9,600	11,600	12,800
~120		10,800	13,000	14,200
~140		11,900	14,300	15,500
~160		13,100	15,500	16,800
~180		14,300	16,900	18,100
~200		15,600	18,200	19,400
~220		16,500	19,400	20,600
~240		17,600	20,500	21,500
~260		18,900	21,700	22,500

レースフレンジ style no.12 (タッセル含む)

H	W	~80	~120	~160	~200	~240	~280	~320
~100		11,700	15,100					
~120		12,700	16,700	22,100				
~140		13,700	18,400	24,200	29,800			
~160		14,700	20,000	26,400	32,300	37,200		
~180		16,000	21,600	28,500	34,800	40,100	48,200	
~200		17,300	23,300	30,500	36,800	44,100	51,700	59,000
~220		18,500	24,900	32,700	39,400	45,900	55,100	62,000
~240		19,800	26,500	34,800	41,900	48,700	58,500	65,800
~260		21,100	29,400	36,900	44,300	51,600	61,900	68,200

スカラップM型

ウェーブ数	3W	4W	5W	6W	7W	
H	100-130	~160	~190	~240	~290	~330
80-100	12,300	15,400	18,600	22,700	29,600	34,100
~120	13,400	17,200	20,800	25,400	33,000	37,400
~140	14,600	18,700	22,700	27,700	36,000	41,500
~160	15,800	19,800	24,200	29,700	38,600	45,100
~180		21,300	26,000	32,000	41,700	49,200
~200			27,900	34,300	44,700	53,300

スカラップW型

ウェーブ数	2W	3W	4W	5W	6W	7W	
H	60-100	~130	~160	~190	~240	~290	~330
80-100	9,800	12,300	15,400	18,600	22,700	29,600	34,100
~120	10,700	13,400	17,200	20,800	25,400	33,000	37,400
~140	11,700	14,600	18,700	22,700	27,700	36,000	41,500
~160		15,800	19,800	24,200	29,700	38,600	45,100
~180			21,300	26,000	32,000	41,700	49,200
~200				27,900	34,300	44,700	53,300

アーチ

H	W	60-100	~130	~160	~190	~240	~290	~330
80-100		9,600	12,000	15,100	18,300	22,400	29,100	33,500
~120		10,500	13,200	17,000	20,500	25,000	32,500	36,900
~140		11,500	14,400	18,500	22,400	27,400	35,500	40,900
~160			15,600	19,600	23,900	29,300	38,100	44,600
~180				21,100	25,700	31,600	41,100	48,600
~200					27,600	34,000	44,200	52,700

レースフレンジ style no.18

ウェーブ数	3W	4W	5W	6W	7W	
H	100-130	~160	~190	~240	~290	~330
80-100	16,200	19,500	23,700	28,900	38,300	43,800
~120	17,300	21,400	26,000	31,600	41,700	47,200
~140	18,500	22,900	27,800	33,900	44,700	51,200
~160	19,700	24,000	29,300	35,900	47,300	54,900
~180		25,400	31,200	38,200	50,300	58,900
~200			33,100	40,500	53,300	63,000

レースフレンジ style no.20

ウェーブ数	2W	3W	4W	5W	6W	7W	
H	60-100	~130	~160	~190	~240	~290	~330
80-100	12,700	16,200	19,500	23,700	28,900	38,300	43,800
~120	13,600	17,300	21,400	26,000	31,600	41,700	47,200
~140	14,600	18,500	22,900	27,800	33,900	44,700	51,200
~160		19,700	24,000	29,300	35,900	47,300	54,900
~180			25,400	31,200	38,200	50,300	58,900
~200				33,100	40,500	53,300	63,000

レースフレンジ style no.27

H	W	60-100	~130	~160	~190	~240	~290	~330
---	---	--------	------	------	------	------	------	------

style no.60 プレーンシェード														
コード式					ドラム式									
H	W	30~45	~90	~140	~190	~240	30~45	~90	~140	~190	~240	~290	~340	~390
50~100		10,800	15,000	20,300	24,400	29,900	13,800	18,000	23,300	27,400	32,900	40,000	45,500	50,300
	~140	12,000	16,200	22,000	26,200	32,100	15,000	19,200	25,000	29,200	35,100	42,500	48,400	53,300
	~180	13,100	17,300	23,600	27,900	34,300	16,100	20,300	26,600	30,900	37,300	44,700	51,000	56,000
	~220	14,200	18,500	25,300	29,600	36,500	17,200	21,500	28,300	32,600	39,500	47,200	53,800	59,000
	~260	15,300	19,700	27,000	31,400	38,700	18,300	22,700	30,000	34,400	41,700	49,400	56,700	61,700
	~300	16,400	20,900	28,600	33,100	40,900	19,400	23,900	31,600	36,100	43,900	51,900	59,300	64,700

※ドラム式：仕上り巾39cm以下の場合、仕上り丈は200cmまでとなります。

スリムシェード	
コード式	
H	W
50~100	18~30
	15,800
	~140
	17,500
	~180
	18,700
	~220
	20,500
	~240
	21,600

style no.63 シャープシェード														
コード式					ドラム式									
H	W	30~45	~90	~140	~190	~240	30~45	~90	~140	~190	~240	~290	~340	~390
50~100		13,500	19,800	27,200	33,800	41,000	16,500	22,800	30,200	36,800	44,000	52,200	59,600	66,100
	~140	14,900	21,600	29,700	36,800	44,800	17,900	24,600	32,700	39,800	47,800	56,400	64,400	71,200
	~180	16,200	23,300	32,200	39,800	48,600	19,200	26,300	35,200	42,800	51,600	60,600	69,400	76,700
	~220	17,500	25,000	34,700	42,700	52,500	20,500	28,000	37,700	45,700	55,500	64,700	74,000	81,700
	~260	18,900	27,100	37,600	46,200	56,900	21,900	30,100	40,600	49,200	59,900	69,700	79,700	87,900
	~300	20,400	29,100	40,500	49,700	61,400	23,400	32,100	43,500	52,700	64,400	74,700	85,500	94,100

※ドラム式：仕上り巾39cm以下の場合、仕上り丈は200cmまでとなります。

style no.50 バルーンブレード														
コード式					ドラム式									
スワッグ数		1S	2S	3S	4S	5S	1S	2S	3S	4S	5S	6S	7S	8S
H	W	36~50	~100	~150	~200	~250	40~50	~100	~150	~200	~250	~300	~350	~400
100~140		19,000	28,200	38,200	48,200	61,000	22,000	31,200	41,200	51,200	64,000	75,900	87,600	99,400
	~180	21,500	31,700	42,900	54,000	68,400	24,500	34,700	45,900	57,000	71,400	84,500	97,700	110,900
	~220	24,100	35,200	47,500	59,900	75,900	27,100	38,200	50,500	62,900	78,900	93,200	107,800	122,400
	~260	25,800	38,800	52,200	65,600	83,400	28,800	41,800	55,200	68,600	86,400	101,900	117,900	130,000
	~300	29,200	42,300	56,900	71,400	90,800	32,200	45,300	59,900	74,400	93,800	110,500	128,000	145,400

※出窓の場合はコーナー1ヶ所につきコード式は3,500円、ドラム式は4,500円プラスになります。

style no.51 バルーンフリル														
コード式					ドラム式									
スワッグ数		1S	2S	3S	4S	5S	1S	2S	3S	4S	5S	6S	7S	8S
H	W	36~50	~100	~150	~200	~250	40~50	~100	~150	~200	~250	~300	~350	~400
100~140		19,600	29,300	39,900	50,500	63,700	22,600	32,300	42,900	53,500	66,700	79,200	91,400	103,700
	~180	22,100	32,900	44,500	56,300	71,200	25,100	35,900	47,500	59,300	74,200	87,800	101,500	115,300
	~220	24,700	36,400	49,200	62,100	78,600	27,700	39,400	52,200	65,100	81,600	96,500	111,600	126,800
	~260	26,400	39,900	53,900	67,800	86,100	29,400	42,900	56,900	70,800	89,100	105,200	121,700	134,300
	~300	29,800	43,400	58,500	73,600	93,600	32,800	46,400	61,500	76,600	96,600	113,800	131,800	149,800

※出窓の場合はコーナー1ヶ所につきコード式は3,500円、ドラム式は4,500円プラスになります。

style no.S01 ロールソフト		
スプリング・チェーンタイプ		
H	W	
		30~60
		~80
		~90
50~80		26,600
		29,100
		31,100
	~120	27,900
		31,000
		33,000
	~160	29,200
		33,000
		35,000
	~200	31,700
		34,700
		36,900
	~240	36,500
		38,800

※丈は巾の3倍までが限度です。

TM-54407



巾 ◇ 100 cm 価格 ◇ 1,400 円/m
 組成 ◇ ポリエステル100%

リピート ◇ タテ cm ヨコ cm
 寸法変化率 ◇ 水洗い/タテ -0.2% ヨコ -0.3%
 ドライ/タテ 0.2% ヨコ -1.0%

取扱表示 ◇ リ-30
 防炎性能 ◇ (イ)
 Made in Japan

H	W	~44	~100	~150	~200	~250	~300	~350	~400
		1巾(片開き)	2巾	3巾	4巾	5巾	6巾	7巾	8巾
~100		3,700	7,300	11,000	14,600	18,200	21,900	25,500	29,200
~120		4,200	8,400	12,500	16,700	20,800	25,000	29,200	33,300
~140		4,700	9,400	14,100	18,800	23,400	28,100	32,800	37,500
~160		5,200	10,400	15,600	20,800	26,000	31,200	36,400	41,600
~180		5,800	11,500	17,200	22,900	28,600	34,400	40,100	45,800
~200		6,300	12,500	18,800	25,000	31,200	37,500	43,700	50,000
~220		6,800	13,600	20,300	27,100	33,800	40,600	47,400	54,100
~240		7,300	14,600	21,900	29,200	36,400	43,700	51,000	58,300
~260		7,800	15,600	23,400	31,200	39,000	46,800	54,600	62,400
~280		8,400	16,700	25,000	33,300	41,600	50,000	58,300	66,600
約1.5倍ヒダ		~56	~120	~200	~266	~333	~400	~466	~533
フラット約1倍ヒダ		~80	~160	~260	~360	~460	~560		

H	W	~44	~100	~150	~200	~250	~300	~350	~400
		1巾(片開き)	2巾	3巾	4巾	5巾	6巾	7巾	8巾
~100		4,000	7,900	11,800	15,700	19,600	23,600	27,500	31,400
~120		4,500	9,000	13,500	18,000	22,400	26,900	31,400	35,900
~140		5,100	10,100	15,200	20,200	25,200	30,300	35,300	40,400
~160		5,600	11,200	16,800	22,400	28,000	33,600	39,200	44,800
~180		6,200	12,400	18,500	24,700	30,800	37,000	43,200	49,300
~200		6,800	13,500	20,200	26,900	33,600	40,400	47,100	53,800
~220		7,300	14,600	21,900	29,200	36,400	43,700	51,000	58,300
~240		7,900	15,700	23,600	31,400	39,200	47,100	54,900	62,800
~260		8,400	16,800	25,200	33,600	42,000	50,400	58,800	67,200
~280		9,000	18,000	26,900	35,900	44,800	53,800	62,800	71,700
約1.5倍ヒダ		~56	~120	~200	~266	~333	~400	~466	~533

H	W	~44	~100	~150	~200	~250	~300	~350	~400
		1巾(片開き)	2巾	3巾	4巾	5巾	6巾	7巾	8巾
~100		4,200	8,400	12,600	16,800	21,000	25,200	29,400	33,600
~120		4,800	9,600	14,400	19,200	24,000	28,800	33,600	38,400
~140		5,400	10,800	16,200	21,600	27,000	32,400	37,800	43,200
~160		6,000	12,000	18,000	24,000	30,000	36,000	42,000	48,000
~180		6,600	13,200	19,800	26,400	33,000	39,600	46,200	52,800
~200		7,200	14,400	21,600	28,800	36,000	43,200	50,400	57,600
~220		7,800	15,600	23,400	31,200	39,000	46,800	54,600	62,400
~240		8,400	16,800	25,200	33,600	42,000	50,400	58,800	67,200
~260		9,000	18,000	27,000	36,000	45,000	54,000	63,000	72,000
~280		9,600	19,200	28,800	38,400	48,000	57,600	67,200	76,800
約1.5倍ヒダ		~56	~120	~200	~266	~333	~400	~466	~533

H	W	~44	~100	~150	~200	~250	~300	~350	~400
		1巾(片開き)	2巾	3巾	4巾	5巾	6巾	7巾	8巾
~100		4,800	9,600	14,300	19,100	23,800	28,600	33,400	38,100
~120		5,500	10,900	16,400	21,800	27,200	32,700	38,100	43,600
~140		6,200	12,300	18,400	24,500	30,600	36,800	42,900	49,000
~160		6,800	13,600	20,400	27,200	34,000	40,800	47,600	54,400
~180		7,500	15,000	22,500	30,000	37,400	44,900	52,400	59,900
~200		8,200	16,400	24,500	32,700	40,800	49,000	57,200	65,300
~220		8,900	17,700	26,600	35,400	44,200	53,100	61,900	70,800
~240		9,600	19,100	28,600	38,100	47,600	57,200	66,700	76,200
~260		10,200	20,400	30,600	40,800	51,000	61,200	71,400	81,600

※片開きはW270cmまで

※片開きはW300cmまで

TM-54408

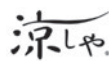

巾 ◇ 150cm 価格 ◇ 2,300円/m
組成 ◇ ポリエステル100%

リポート ◇ タテ7.5cm ヨコーcm
寸法変化率 ◇ 水洗い/タテ -0.5% ヨコ 0.0%
ドライ/タテ -0.5% ヨコ 0.0%

取扱い表示 ◇ リ-30
防炎性能 ◇ (イ)
Made in Japan

H	W	~67 1巾(片開き)	~150 2巾	~225 3巾	~300 4巾	~375 5巾	~450 6巾	~525 7巾	~600 8巾
~100		6,300	12,000	17,700	23,500	29,600	35,300	41,000	46,800
~120		7,100	13,600	20,500	27,100	34,100	40,700	47,600	54,200
~140		7,400	14,800	22,200	29,600	36,900	44,300	51,700	59,100
~160		8,700	16,900	25,100	33,300	41,900	50,100	58,300	66,500
~180		9,500	18,600	27,900	36,900	46,400	55,500	64,800	73,800
~200		9,900	19,700	29,600	39,400	49,200	59,100	68,900	78,800
~220		11,200	21,800	32,500	43,200	54,200	64,800	75,500	86,100
~240		12,000	23,500	35,300	46,800	58,700	70,200	82,000	93,500
~260		12,300	24,600	36,900	49,200	61,500	73,800	86,100	98,400
~280		13,600	26,800	39,900	53,000	66,500	79,600	92,700	105,800
約1.5倍ヒダ		~88	~200	~300	~400	~500	~600	~700	~800
フラット前ヒダ		~130	~260	~410	~560				

H	W	~67 1巾(片開き)	~150 2巾	~225 3巾	~300 4巾	~375 5巾	~450 6巾	~525 7巾	~600 8巾
~100		6,700	12,900	19,000	25,200	31,700	37,900	44,000	50,000
~120		7,600	14,600	22,000	29,100	36,600	43,700	51,100	58,000
~140		8,000	15,900	23,800	31,700	39,600	47,600	55,500	63,000
~160		9,400	18,200	27,000	35,800	44,900	53,700	62,500	71,000
~180		10,200	19,900	30,000	39,600	49,800	59,500	69,600	79,000
~200		10,600	21,200	31,700	42,300	52,800	63,400	74,000	84,000
~220		12,000	23,400	34,900	46,300	58,100	69,600	81,000	92,000
~240		12,900	25,200	37,900	50,200	63,000	75,400	88,000	100,000
~260		13,200	26,400	39,600	52,800	66,000	79,200	92,400	105,000
~280		14,600	28,700	42,800	56,900	71,300	85,400	99,500	113,000
約1.5倍ヒダ		~88	~200	~300	~400	~500			

※片開きはW270cmまで

H	W	~67 1巾(片開き)	~150 2巾	~225 3巾	~300 4巾	~375 5巾	~450 6巾	~525 7巾	~600 8巾
~100		7,200	13,800	20,300	26,900	33,900	40,500	47,000	53,000
~120		8,100	15,600	23,500	31,100	39,100	46,700	54,600	62,000
~140		8,500	17,000	25,400	33,900	42,300	50,800	59,300	67,000
~160		10,000	19,400	28,800	38,200	48,000	57,400	66,800	75,000
~180		10,900	21,300	32,000	42,300	53,200	63,600	74,300	84,000
~200		11,300	22,600	33,900	45,200	56,400	67,700	79,000	90,000
~220		12,800	25,000	37,300	49,500	62,100	74,300	86,500	98,000
~240		13,800	26,900	40,500	53,600	67,300	80,500	94,000	107,000
~260		14,100	28,200	42,300	56,400	70,500	84,600	98,700	112,000
~280		15,600	30,700	45,700	60,800	76,200	91,200	106,300	121,000
約1.5倍ヒダ		~88	~200	~300	~400	~500			

※片開きはW270cmまで

H	W	~67 1巾(片開き)	~150 2巾	~225 3巾	~300 4巾	~375 5巾	~450 6巾	~525 7巾	~600 8巾
~100		8,100	15,500	22,900	30,400	38,200	45,600	53,000	60,500
~120		9,200	17,600	26,500	35,000	44,100	52,600	61,500	70,000
~140		9,600	19,100	28,700	38,200	47,700	57,300	66,800	76,400
~160		11,300	21,900	32,500	43,100	54,100	64,700	75,300	85,900
~180		12,300	24,000	36,100	47,700	60,000	71,700	83,800	95,400
~200		12,800	25,500	38,200	50,900	63,600	76,400	89,100	101,800
~220		14,500	28,200	42,000	55,800	70,000	83,800	97,600	111,300
~240		15,500	30,400	45,600	60,500	75,900	90,800	106,000	120,900
~260		15,900	31,800	47,700	63,600	79,500	95,400	111,300	127,200

※片開きはW300cmまで

		コード式					ドラム式							
H	W	30~45	~90	~140	~190	~240	30~45	~90	~140	~190	~240	~290	~340	~390
50~100		12,500	16,600	21,100	27,500	32,200	15,500	19,600	24,100	30,500	35,200	42,400	49,600	54,300
~140		14,400	18,500	23,300	30,500	35,500	17,400	21,500	26,300	33,500	38,500	45,900	54,200	59,100
~180		16,000	20,200	25,200	33,300	38,400	19,000	23,200	28,200	36,300	41,400	49,000	57,900	62,900
~220		17,500	21,700	26,900	35,900	41,200	20,500	24,700	29,900	38,900	44,200	52,000	61,900	67,000
~260		19,300	23,700	29,100	38,900	44,400	22,300	26,700	32,100	41,900	47,400	55,300	66,500	71,500
~300		21,000	25,400	31,000	41,600	47,400	24,000	28,400	34,000	44,600	50,400	58,600	70,300	75,600

※ドラム式：仕上り巾39cm以下の場合、仕上り丈は200cmまでとなります。

		コード式
H	W	18~30
50~100		17,300
~140		19,700
~180		21,400
~220		23,500
~240		25,000

		コード式					ドラム式							
スワッグ数	W	1S	2S	3S	4S	5S	1S	2S	3S	4S	5S	6S	7S	8S
100~140		20,200	31,400	43,600	55,600	69,500	23,200	34,400	46,600	58,600	72,500	83,400	97,200	111,100
~180		23,000	35,700	49,300	63,000	78,800	26,000	38,700	52,300	66,000	81,800	93,700	109,400	125,000
~220		25,600	39,700	55,000	70,300	87,900	28,600	42,700	58,000	73,300	90,900	103,700	121,300	138,900
~260		27,800	44,200	61,300	78,200	97,900	30,800	47,200	64,300	81,200	100,900	114,700	134,200	150,000
~300		31,400	48,500	67,000	85,600	107,200	34,400	51,500	70,000	88,600	110,200	125,000	146,400	167,800

※出窓の場合はコーナー1ヶ所につきコード式は3,500円、ドラム式は4,500円プラスになります。

		style no.60 プレーンシェード												
		コード式					ドラム式							
H	W	30~45	~90	~140	~190	~240	30~45	~90	~140	~190	~240	~290	~340	~390
50~100		12,400	16,500	21,100	27,400	32,100	15,400	19,500	24,100	30,400	35,100	42,300	49,400	54,200
	~140	14,100	18,200	23,000	30,200	35,100	17,100	21,200	26,000	33,200	38,100	45,600	53,600	58,500
	~180	15,700	19,900	24,900	32,900	38,100	18,700	22,900	27,900	35,900	41,100	48,600	57,500	62,500
	~220	17,400	21,600	26,800	35,700	41,000	20,400	24,600	29,800	38,700	44,000	51,800	61,600	66,700
	~260	19,000	23,300	28,800	38,400	44,000	22,000	26,300	31,800	41,400	47,000	54,900	65,700	70,700
	~300	20,600	25,100	30,700	41,200	47,000	23,600	28,100	33,700	44,200	50,000	58,100	69,700	75,000

※ドラム式：仕上り巾39cm以下の場合、仕上り丈は200cmまでとなります。

		スリムシェード	
		コード式	
H	W	18~30	
50~100		17,200	
	~140	19,400	
	~180	21,100	
	~220	23,400	
	~240	24,700	

		style no.63 シャープシェード												
		コード式					ドラム式							
H	W	30~45	~90	~140	~190	~240	30~45	~90	~140	~190	~240	~290	~340	~390
50~100		15,100	21,400	28,000	37,100	43,400	18,100	24,400	31,000	40,100	46,400	54,600	63,600	70,200
	~140	17,000	23,700	30,800	41,100	48,100	20,000	26,700	33,800	44,100	51,100	59,600	69,800	76,600
	~180	18,900	26,000	33,500	45,200	52,700	21,900	29,000	36,500	48,200	55,700	64,600	76,200	83,500
	~220	20,700	28,300	36,300	49,200	57,300	23,700	31,300	39,300	52,200	60,300	69,600	82,100	89,800
	~260	22,700	30,800	39,500	53,800	62,600	25,700	33,800	42,500	56,800	65,600	75,400	89,200	97,300
	~300	24,700	33,400	42,600	58,300	67,900	27,700	36,400	45,600	61,300	70,900	81,200	96,300	104,900

※ドラム式：仕上り巾39cm以下の場合、仕上り丈は200cmまでとなります。

		style no.50 バルーンプレーン												
		コード式					ドラム式							
スワッグ数		1S	2S	3S	4S	5S	1S	2S	3S	4S	5S	6S	7S	8S
H	W	36~50	~100	~150	~200	~250	40~50	~100	~150	~200	~250	~300	~350	~400
100~140		20,000	31,100	43,000	55,000	68,600	23,000	34,100	46,000	58,000	71,600	82,600	96,200	109,900
	~180	22,700	35,300	48,900	62,400	78,000	25,700	38,300	51,900	65,400	81,000	92,900	108,500	124,100
	~220	25,500	39,600	54,700	69,900	87,400	28,500	42,600	57,700	72,900	90,400	103,300	120,800	138,300
	~260	27,500	43,800	60,600	77,400	96,800	30,500	46,800	63,600	80,400	99,800	113,600	133,000	148,400
	~300	31,100	48,000	66,500	84,900	106,200	34,100	51,000	69,500	87,900	109,200	124,000	145,300	166,500

※出窓の場合はコーナー1ヶ所につきコード式は3,500円、ドラム式は4,500円プラスになります。

		style no.51 バルーンフリル												
		コード式					ドラム式							
スワッグ数		1S	2S	3S	4S	5S	1S	2S	3S	4S	5S	6S	7S	8S
H	W	36~50	~100	~150	~200	~250	40~50	~100	~150	~200	~250	~300	~350	~400
100~140		21,100	33,400	46,400	59,500	74,200	24,100	36,400	49,400	62,500	77,200	89,200	104,000	118,700
	~180	23,800	37,700	52,300	66,900	83,600	26,800	40,700	55,300	69,900	86,600	99,600	116,200	132,900
	~220	26,600	41,900	58,200	74,400	93,000	29,600	44,900	61,200	77,400	96,000	109,900	128,500	147,100
	~260	28,600	46,100	64,000	81,900	102,400	31,600	49,100	67,000	84,900	105,400	120,300	140,800	157,300
	~300	32,200	50,400	69,900	89,400	111,800	35,200	53,400	72,900	92,400	114,800	130,600	153,000	175,400

※出窓の場合はコーナー1ヶ所につきコード式は3,500円、ドラム式は4,500円プラスになります。

		style no.S01 ロールソフト				
		スプリング・チェーンタイプ				
H	W	30~60	~80	~100	~120	~140
50~80		28,000	30,500	32,500	33,700	35,400
	~120	29,800	32,900	34,900	36,000	37,900
	~160	31,600	35,400	37,400	38,600	39,900
	~200	34,600	37,600	39,800	41,000	42,300
	~240		39,900	42,200	43,400	44,800

※丈は巾の3倍までが限度です。

※ロールソフト加工品は非防炎品になります。

		style no.60 プレーンシェード												
		コード式					ドラム式							
H	W	30~45	~90	~140	~190	~240	30~45	~90	~140	~190	~240	~290	~340	~390
50~100		11,500	15,600	21,600	25,800	31,800	14,500	18,600	24,600	28,800	34,800	42,000	48,200	53,000
	~140	12,900	17,000	23,700	27,900	34,500	15,900	20,000	26,700	30,900	37,500	45,000	51,800	56,700
	~180	14,200	18,400	25,600	29,900	37,200	17,200	21,400	28,600	32,900	40,200	47,700	55,000	60,000
	~220	15,400	19,700	27,700	32,000	39,900	18,400	22,700	30,700	35,000	42,900	50,700	58,500	63,600
	~260	16,800	21,300	30,100	34,400	43,100	19,800	24,300	33,100	37,400	46,100	54,000	62,800	67,800
	~300	18,200	22,700	32,000	36,400	45,800	21,200	25,700	35,000	39,400	48,800	56,900	66,100	71,400

※ドラム式: 仕上り巾39cm以下の場合、仕上り丈は200cmまでとなります。

		スリムシェード	
		コード式	
H	W	18~30	
50~100		16,400	
	~140	18,300	
	~180	19,700	
	~220	21,500	
	~240	22,800	

		style no.50 バルーンプレーン												
		コード式					ドラム式							
スワッグ数		1S	2S	3S	4S	5S	1S	2S	3S	4S	5S	6S	7S	8S
H	W	36~50	~100	~150	~200	~250	40~50	~100	~150	~200	~250	~300	~350	~400
100~140		20,600	30,500	41,300	52,200	66,400	23,600	33,500	44,300	55,200	69,400	82,100	94,600	107,100
	~180	23,400	34,500	46,600	58,700	74,900	26,400	37,500	49,600	61,700	77,900	91,900	106,000	120,100
	~220	26,300	38,500	51,900	65,200	83,400	29,300	41,500	54,900	68,200	86,400	101,700	117,400	133,100
	~260	28,700	43,000	57,800	72,600	93,200	31,700	46,000	60,800	75,600	96,200	113,100	130,500	143,900
	~300	32,300	46,900	63,100	79,200	101,700	35,300	49,900	66,100	82,200	104,700	122,900	141,900	160,900

※出窓の場合はコーナー1ヶ所につきコード式は3,500円、ドラム式は4,500円プラスになります。

		style no.51 バルーンフリル												
		コード式					ドラム式							
スワッグ数		1S	2S	3S	4S	5S	1S	2S	3S	4S	5S	6S	7S	8S
H	W	36~50	~100	~150	~200	~250	40~50	~100	~150	~200	~250	~300	~350	~400
100~140		21,700	32,500	44,300	56,000	71,200	24,700	35,500	47,300	59,000	74,200	87,800	101,200	114,700
	~180	24,400	36,400	49,500	62,500	79,700	27,400	39,400	52,500	65,500	82,700	97,600	112,700	127,700
	~220	27,300	40,500	54,800	69,100	88,100	30,300	43,500	57,800	72,100	91,100	107,500	124,100	140,700
	~260	29,700	44,900	60,800	76,500	98,000	32,700	47,900	63,800	79,500	101,000	118,800	137,200	151,500
	~300	33,300	48,900	66,000	83,000	106,500	36,300	51,900	69,000	86,000	109,500	128,600	148,600	168,400

※出窓の場合はコーナー1ヶ所につきコード式は3,500円、ドラム式は4,500円プラスになります。

		style no.S01 ロールソフト		
		スプリング・チェーンタイプ		
H	W	30~60	~80	~90
50~80		27,200	29,700	31,700
	~120	28,700	31,800	33,800
	~160	30,200	34,000	36,000
	~200	32,700	35,700	37,900
	~240		38,000	40,300

※丈は巾の3倍までが限度です。

※ロールソフト加工品は非防炎品になります。

		style no.60 プレーンシェード												
		コード式					ドラム式							
H	W	30~45	~90	~140	~190	~240	30~45	~90	~140	~190	~240	~290	~340	~390
50~100		12,100	16,100	22,700	26,700	33,300	15,100	19,100	25,700	29,700	36,300	43,500	50,300	55,100
	~140	13,600	17,800	25,100	29,300	36,700	16,600	20,800	28,100	32,300	39,700	47,200	54,700	59,600
	~180	15,100	19,300	27,600	31,800	40,100	18,100	22,300	30,600	34,800	43,100	50,700	58,900	63,900
	~220	16,600	20,900	30,000	34,300	43,500	19,600	23,900	33,000	37,300	46,500	54,300	63,300	68,500
	~260	18,100	22,500	32,500	36,800	46,800	21,100	25,500	35,500	39,800	49,800	57,700	67,800	72,800
	~300	19,600	24,100	35,000	39,300	50,200	22,600	27,100	38,000	42,300	53,200	61,400	72,000	77,400

※ドラム式:仕上り巾39cm以下の場合、仕上り丈は200cmまでとなります。

		スリムシェード	
		コード式	
H	W	18~30	
50~100		16,900	
	~140	19,000	
	~180	20,600	
	~220	22,700	
	~240	24,000	

		style no.63 シャープシェード												
		コード式					ドラム式							
H	W	30~45	~90	~140	~190	~240	30~45	~90	~140	~190	~240	~290	~340	~390
50~100		14,800	21,100	29,700	36,300	44,700	17,800	24,100	32,700	39,300	47,700	55,900	64,500	71,100
	~140	16,500	23,200	33,000	40,100	49,800	19,500	26,200	36,000	43,100	52,800	61,300	71,000	77,900
	~180	18,200	25,400	36,300	43,900	54,900	21,200	28,400	39,300	46,900	57,900	66,800	77,700	85,000
	~220	20,000	27,500	39,600	47,700	59,900	23,000	30,500	42,600	50,700	62,900	72,200	83,900	91,600
	~260	21,800	29,900	43,400	52,000	65,600	24,800	32,900	46,400	55,000	68,600	78,400	91,300	99,500
	~300	23,700	32,400	47,100	56,300	71,400	26,700	35,400	50,100	59,300	74,400	84,600	98,700	107,400

※ドラム式:仕上り巾39cm以下の場合、仕上り丈は200cmまでとなります。

		style no.50 バルーンプレーン												
		コード式					ドラム式							
スラッグ数		1S	2S	3S	4S	5S	1S	2S	3S	4S	5S	6S	7S	8S
H	W	36~50	~100	~150	~200	~250	40~50	~100	~150	~200	~250	~300	~350	~400
100~140		22,000	32,600	44,100	55,600	71,300	25,000	35,600	47,100	58,600	74,300	87,600	100,900	114,100
	~180	25,200	37,200	50,200	63,200	81,300	28,200	40,200	53,200	66,200	84,300	99,300	114,300	129,300
	~220	28,500	41,900	56,400	70,900	91,300	31,500	44,900	59,400	73,900	94,300	110,800	127,700	144,500
	~260	31,000	46,500	62,500	78,500	101,400	34,000	49,500	65,500	81,500	104,400	122,500	141,100	155,700
	~300	35,000	51,100	68,600	86,100	111,400	38,000	54,100	71,600	89,100	114,400	134,100	154,500	174,900

※出窓の場合はコーナー1ヶ所につきコード式は3,500円、ドラム式は4,500円プラスになります。

		style no.51 バルーンフリル												
		コード式					ドラム式							
スラッグ数		1S	2S	3S	4S	5S	1S	2S	3S	4S	5S	6S	7S	8S
H	W	36~50	~100	~150	~200	~250	40~50	~100	~150	~200	~250	~300	~350	~400
100~140		23,500	35,500	48,400	61,200	78,300	26,500	38,500	51,400	64,200	81,300	96,000	110,600	125,200
	~180	26,700	40,100	54,500	68,900	88,300	29,700	43,100	57,500	71,900	91,300	107,600	124,000	140,400
	~220	30,000	44,700	60,600	76,500	98,300	33,000	47,700	63,600	79,500	101,300	119,200	137,400	155,600
	~260	32,500	49,400	66,700	84,100	108,400	35,500	52,400	69,700	87,100	111,400	130,800	150,800	166,800
	~300	36,600	54,000	72,900	91,800	118,400	39,600	57,000	75,900	94,800	121,400	142,400	164,200	186,000

※出窓の場合はコーナー1ヶ所につきコード式は3,500円、ドラム式は4,500円プラスになります。

TM-54413

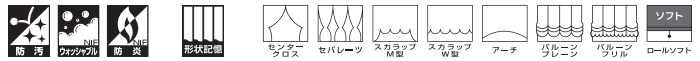

巾 ◇ 100cm 価格 ◇ 750円/㎡
 組成 ◇ ポリエステル100%

リピーター ◇ タテ cm ヨコ cm
 寸法変化率 ◇ 水洗い/タテ 0.2% ヨコ -0.1%
 ドライ/タテ -0.2% ヨコ 0.0%

取扱表示 ◇ リ-30
 防炎性能 ◇ (イ) あて布使用
 Made in Japan

標準仕様		レギュラー縫製仕様価格表 約2倍ヒダ (タッセルなし)							
H	W	~44 1巾(片開き)	~100 2巾	~150 3巾	~200 4巾	~250 5巾	~300 6巾	~350 7巾	~400 8巾
~100		2,800	5,500	8,200	11,000	13,700	16,400	19,200	21,900
~120		3,200	6,300	9,400	12,500	15,600	18,800	21,900	25,000
~140		3,600	7,100	10,600	14,100	17,600	21,100	24,600	28,100
~160		3,900	7,800	11,700	15,600	19,500	23,400	27,300	31,200
~180		4,300	8,600	12,900	17,200	21,500	25,800	30,100	34,400
~200		4,700	9,400	14,100	18,800	23,400	28,100	32,800	37,500
~220		5,100	10,200	15,300	20,300	25,400	30,500	35,500	40,600
~240		5,500	11,000	16,400	21,900	27,300	32,800	38,300	43,700
~260		5,900	11,700	17,600	23,400	29,300	35,100	41,000	46,800
~280		6,300	12,500	18,800	25,000	31,200	37,500	43,700	50,000
約1.5倍ヒダ		~56	~120	~200	~266	~333	~400	~466	~533
フラット前ヒダ		~80	~160	~260	~360	~460	~560		

形状記憶加工価格表 約2倍ヒダ (タッセルなし)									
H	W	~44 1巾(片開き)	~100 2巾	~150 3巾	~200 4巾	~250 5巾	~300 6巾	~350 7巾	~400 8巾
~100		3,900	7,700	11,600	15,400	19,300	23,100	27,000	30,800
~120		4,400	8,800	13,200	17,600	22,000	26,400	30,800	35,200
~140		5,000	9,900	14,900	19,800	24,800	29,700	34,700	39,600
~160		5,500	11,000	16,500	22,000	27,500	33,000	38,500	44,000
~180		6,100	12,100	18,200	24,200	30,300	36,300	42,400	48,400
~200		6,600	13,200	19,800	26,400	33,000	39,600	46,200	52,800
~220		7,200	14,300	21,500	28,600	35,800	42,900	50,100	57,200
~240		7,700	15,400	23,100	30,800	38,500	46,200	53,900	61,600
~260		8,300	16,500	24,800	33,000	41,300	49,500	57,800	66,000

※片開きはW300cmまで

センタークロス								
共生地フリル style no.11 (タッセル含む)								
H	W	~80	~120	~160	~200	~240	~280	~320
~100		7,700	9,800					
~120		8,400	11,100	15,000				
~140		9,100	12,500	16,800	21,000			
~160		9,800	13,700	18,600	23,200	26,900		
~180		10,800	15,100	20,400	25,400	29,400	35,700	
~200		11,700	16,400	22,100	27,100	33,000	38,800	44,700
~220		12,600	17,700	24,000	29,300	34,500	41,800	47,300
~240		13,600	19,100	25,700	31,500	37,000	44,900	50,800
~260		14,600	21,700	27,500	33,600	39,600	48,000	52,900
~280								
~320								
~360								

レースフレンジ style no.12 (タッセル含む)								
H	W	~80	~120	~160	~200	~240	~280	~320
~100		11,700	15,100					
~120		12,700	16,700	22,100				
~140		13,700	18,400	24,200	29,800			
~160		14,700	20,000	26,400	32,300	37,200		
~180		16,000	21,600	28,500	34,800	40,100	48,200	
~200		17,300	23,300	30,500	36,800	44,100	51,700	59,000
~220		18,500	24,900	32,700	39,400	45,900	55,100	62,000
~240		19,800	26,500	34,800	41,900	48,700	58,500	65,800
~260		21,100	29,400	36,900	44,300	51,600	61,900	68,200

セパレーツ				
共生地フリル style no.15 (タッセル含む)				
H	W	~40(1P)	~50(1P)	~60(1P)
~100		9,600	11,600	12,800
~120		10,800	13,000	14,200
~140		11,900	14,300	15,500
~160		13,100	15,500	16,800
~180		14,300	16,900	18,100
~200		15,600	18,200	19,400
~220		16,500	19,400	20,600
~240		17,600	20,500	21,500
~260		18,900	21,700	22,500

スカラップM型						
共生地フリル style no.17						
ウェーブ数	3W	4W	5W	6W	7W	
80~100	12,300	15,400	18,600	22,700	29,600	34,100
~120	13,400	17,200	20,800	25,400	33,000	37,400
~140	14,600	18,700	22,700	27,700	36,000	41,500
~160	15,800	19,800	24,200	29,700	38,600	45,100
~180	17,100	21,300	26,000	32,000	41,700	49,200
~200	18,400	22,900	27,900	34,300	44,700	53,300
~220	19,700	24,600	30,000	37,000	48,000	57,400
~240	21,000	26,500	32,300	40,100	51,700	61,500
~260	22,300	28,600	34,800	43,600	55,900	65,600
~280	23,600	30,900	37,600	47,500	60,700	70,300
~300	24,900	33,400	40,700	51,900	66,100	75,600
~320	26,200	36,100	44,300	56,800	72,200	81,500
~340	27,500	39,000	48,400	62,000	78,900	88,000
~360	28,800	42,100	53,100	68,200	86,300	95,200
~380	30,100	45,400	58,500	74,900	94,500	103,100
~400	31,400	48,900	64,600	82,200	103,600	111,700
~420	32,700	52,600	71,500	90,300	113,600	121,000
~440	34,000	56,500	79,200	99,300	124,500	131,100
~460	35,300	60,600	87,700	109,300	136,400	142,000
~480	36,600	64,900	97,000	120,400	149,300	153,800
~500	37,900	69,400	107,200	132,700	163,300	166,600
~520	39,200	74,100	118,400	146,300	178,500	180,500
~540	40,500	79,000	130,700	161,300	195,000	195,600
~560	41,800	84,100	144,200	177,800	212,900	212,000
~580	43,100	89,400	158,900	195,700	232,300	230,800
~600	44,400	94,900	174,900	214,900	253,300	252,100
~620	45,700	100,600	192,200	236,500	276,000	276,000
~640	47,000	106,500	210,900	260,800	300,500	301,600
~660	48,300	112,600	231,100	287,900	326,900	329,000
~680	49,600	118,900	252,900	317,900	355,300	358,400
~700	50,900	125,400	276,400	350,900	385,800	390,000
~720	52,200	132,100	301,700	387,100	418,500	423,800
~740	53,500	139,000	328,900	426,700	453,600	460,000
~760	54,800	146,100	358,200	469,900	491,300	498,800
~780	56,100	153,400	389,700	516,900	531,800	540,400
~800	57,400	160,900	423,500	567,900	575,300	584,900
~820	58,700	168,600	459,800	623,100	622,000	632,600
~840	60,000	176,500	498,700	682,700	672,300	683,700
~860	61,300	184,600	540,400	746,100	726,500	738,500
~880	62,600	192,900	584,900	813,700	784,900	796,200
~900	63,900	201,400	632,400	885,900	847,800	857,100
~920	65,200	210,100	683,100	962,100	915,600	921,600
~940	66,500	219,000	736,400	1042,800	988,700	990,100
~960	67,800	228,100	792,700	1127,600	1066,500	1063,000
~980	69,100	237,400	852,400	1216,100	1150,400	1150,800
~1000	70,400	246,900	914,900	1308,900	1240,900	1244,900
~1020	71,700	256,600	980,700	1406,600	1338,600	1345,800
~1040	73,000	266,500	1050,400	1509,800	1443,900	1453,400
~1060	74,300	276,600	1123,600	1618,100	1557,400	1568,100
~1080	75,600	286,900	1200,900	1732,100	1679,600	1690,600
~1100	76,900	297,400	1282,900	1852,400	1811,300	1821,700
~1120	78,200	308,100	1369,400	1978,600	1953,200	1972,000
~1140	79,500	319,000	1461,100	2111,400	2106,100	2132,100
~1160	80,800	330,100	1558,600	2251,400	2270,800	2302,800
~1180	82,100	341,400	1661,600	2400,400	2448,100	2484,800
~1200	83,400	352,900	1770,700	2558,100	2638,900	2688,900
~1220	84,700	364,600	1885,600	2725,200	2843,100	2906,100
~1240	86,000	376,500	2007,100	2900,900	3061,600	3137,600
~1260	87,300	388,600	2135,100	3085,900	3294,400	3383,400
~1280	88,600	400,900	2269,400	3280,100	3541,600	3644,800
~1300	89,900	413,400	2410,700	3483,600	3803,400	3921,600
~1320	91,200	426,100	2558,900	3696,400	4080,100	4214,600
~1340	92,500	439,000	2713,900	3919,400	4372,100	4524,400
~1360	93,800	452,100	2875,600	4153,400	4679,600	4851,600
~1380	95,100	465,400	3043,900	4398,400	5003,400	5196,800
~1400	96,400	478,900	3218,700	4654,400	5344,100	5560,600
~1420	97,700	492,600	3400,000	4921,400	5702,400	5943,600
~1440	99,000	506,500	3587,900	5199,400	6078,900	6346,600
~1460	100,300	520,600	3782,400	5488,400	6474,100	6770,400
~1480	101,600	534,900	3983,400	5788,400	6888,600	7215,600
~1500	102,900	549,400	4190,900	6099,400	7322,100	7682,600
~1520	104,200	564,100	4404,900	6421,400	7775,100	8171,600
~1540	105,500	579,000	4625,400	6754,400	8348,100	8683,400
~1560	106,800	594,100	4852,400	7108,400	8941,600	9218,600
~1580	108,100	609,400	5085,900	7483,400	9556,100	9777,600
~1600	109,400	624,900	5325,900	7879,40		



style no.50 バルーンプレーン

スラッグ数 H \ W	コード式					ドラム式							
	1S	2S	3S	4S	5S	1S	2S	3S	4S	5S	6S	7S	8S
36~50	~100	~150	~200	~250		40~50	~100	~150	~200	~250	~300	~350	~400
100-140	19,000	28,200	38,200	48,200	61,000	22,000	31,200	41,200	51,200	64,000	75,900	87,600	99,400
~180	21,500	31,700	42,900	54,000	68,400	24,500	34,700	45,900	57,000	71,400	84,500	97,700	110,900
~220	24,100	35,200	47,500	59,900	75,900	27,100	38,200	50,500	62,900	78,900	93,200	107,800	122,400
~260	25,800	38,800	52,200	65,600	83,400	28,800	41,800	55,200	68,600	86,400	101,900	117,900	130,000
~300	29,200	42,300	56,900	71,400	90,800	32,200	45,300	59,900	74,400	93,800	110,500	128,000	145,400

※ 出窓の場合はコーナー1ヶ所につきコード式は3,500円、ドラム式は4,500円プラスになります。



style no.51 バルーンフリル

スラッグ数 H \ W	コード式					ドラム式							
	1S	2S	3S	4S	5S	1S	2S	3S	4S	5S	6S	7S	8S
36~50	~100	~150	~200	~250		40~50	~100	~150	~200	~250	~300	~350	~400
100-140	19,600	29,300	39,900	50,500	63,700	22,600	32,300	42,900	53,500	66,700	79,200	91,400	103,700
~180	22,100	32,900	44,500	56,300	71,200	25,100	35,900	47,500	59,300	74,200	87,800	101,500	115,300
~220	24,700	36,400	49,200	62,100	78,600	27,700	39,400	52,200	65,100	81,600	96,500	111,600	126,800
~260	26,400	39,900	53,900	67,800	86,100	29,400	42,900	56,900	70,800	89,100	105,200	121,700	134,300
~300	29,800	43,400	58,500	73,600	93,600	32,800	46,400	61,500	76,600	96,600	113,800	131,800	149,800

※ 出窓の場合はコーナー1ヶ所につきコード式は3,500円、ドラム式は4,500円プラスになります。



style no.S01 ロールソフト

スプリング・チェーンタイプ

H \ W	スプリング・チェーンタイプ		
	30~60	~80	~90
50~80	26,600	29,100	31,100
~120	27,900	31,000	33,000
~160	29,200	33,000	35,000
~200	31,700	34,700	36,900
~240		36,500	38,800

※ 丈は巾の3倍までが限度です。

※ ロールソフト加工品は非防災品になります。

TM-54414



巾 ◇ 100cm 価格 ◇ 1,000円/m
 組成 ◇ ポリエステル100%

リポート ◇ タテ cm ヨコ cm
 寸法変化率 ◇ 水洗い/タテ 0.2% ヨコ -0.1%
 ドライ/タテ -0.2% ヨコ 0.0%

取扱い表示 ◇ リ-30 30 30 30 30 30 30 30
 防炎性能 ◇ (イ) あて布使用
 Made in Japan

H	W	~44 1巾(片開き)	~100 2巾	~150 3巾	~200 4巾	~250 5巾	~300 6巾	~350 7巾	~400 8巾
~100	3,100	6,200	9,300	12,400	15,400	18,500	21,600	24,700	
~120	3,600	7,100	10,600	14,100	17,600	21,200	24,700	28,200	
~140	4,000	8,000	11,900	15,900	19,800	23,800	27,800	31,700	
~160	4,400	8,800	13,200	17,600	22,000	26,400	30,800	35,200	
~180	4,900	9,700	14,600	19,400	24,200	29,100	33,900	38,800	
~200	5,300	10,600	15,900	21,200	26,400	31,700	37,000	42,300	
~220	5,800	11,500	17,200	22,900	28,600	34,400	40,100	45,800	
~240	6,200	12,400	18,500	24,700	30,800	37,000	43,200	49,300	
~260	6,600	13,200	19,800	26,400	33,000	39,600	46,200	52,800	
~280	7,100	14,100	21,200	28,200	35,200	42,300	49,300	56,400	
約1.5倍ヒダ	~56	~120	~200	~266	~333	~400	~466	~533	
フラット前ヒダ	~80	~160	~260	~360	~460	~560			

H	W	~44 1巾(片開き)	~100 2巾	~150 3巾	~200 4巾	~250 5巾	~300 6巾	~350 7巾	~400 8巾
~100	3,400	6,800	10,100	13,500	16,800	20,200	23,600	26,900	
~120	3,900	7,700	11,600	15,400	19,200	23,100	26,900	30,800	
~140	4,400	8,700	13,000	17,300	21,600	26,000	30,300	34,600	
~160	4,800	9,600	14,400	19,200	24,000	28,800	33,600	38,400	
~180	5,300	10,600	15,900	21,200	26,400	31,700	37,000	42,300	
~200	5,800	11,600	17,300	23,100	28,800	34,600	40,400	46,100	
~220	6,300	12,500	18,800	25,000	31,200	37,500	43,700	50,000	
~240	6,800	13,500	20,200	26,900	33,600	40,400	47,100	53,800	
~260	7,200	14,400	21,600	28,800	36,000	43,200	50,400	57,600	
~280	7,700	15,400	23,100	30,800	38,400	46,100	53,800	61,500	
約1.5倍ヒダ	~56	~120	~200	~266	~333	~400	~466	~533	

※片開きはW270cmまで

H	W	~44 1巾(片開き)	~100 2巾	~150 3巾	~200 4巾	~250 5巾	~300 6巾	~350 7巾	~400 8巾
~100	3,700	7,300	11,000	14,600	18,200	21,900	25,500	29,200	
~120	4,200	8,400	12,500	16,700	20,800	25,000	29,200	33,300	
~140	4,700	9,400	14,100	18,800	23,400	28,100	32,800	37,500	
~160	5,200	10,400	15,600	20,800	26,000	31,200	36,400	41,600	
~180	5,800	11,500	17,200	22,900	28,600	34,400	40,100	45,800	
~200	6,300	12,500	18,800	25,000	31,200	37,500	43,700	50,000	
~220	6,800	13,600	20,300	27,100	33,800	40,600	47,400	54,100	
~240	7,300	14,600	21,900	29,200	36,400	43,700	51,000	58,300	
~260	7,800	15,600	23,400	31,200	39,000	46,800	54,600	62,400	
~280	8,400	16,700	25,000	33,300	41,600	50,000	58,300	66,600	
約1.5倍ヒダ	~56	~120	~200	~266	~333	~400	~466	~533	

※片開きはW270cmまで

H	W	~44 1巾(片開き)	~100 2巾	~150 3巾	~200 4巾	~250 5巾	~300 6巾	~350 7巾	~400 8巾
~100	4,200	8,400	12,600	16,800	21,000	25,200	29,400	33,600	
~120	4,800	9,600	14,400	19,200	24,000	28,800	33,600	38,400	
~140	5,400	10,800	16,200	21,600	27,000	32,400	37,800	43,200	
~160	6,000	12,000	18,000	24,000	30,000	36,000	42,000	48,000	
~180	6,600	13,200	19,800	26,400	33,000	39,600	46,200	52,800	
~200	7,200	14,400	21,600	28,800	36,000	43,200	50,400	57,600	
~220	7,800	15,600	23,400	31,200	39,000	46,800	54,600	62,400	
~240	8,400	16,800	25,200	33,600	42,000	50,400	58,800	67,200	
~260	9,000	18,000	27,000	36,000	45,000	54,000	63,000	72,000	

※片開きはW300cmまで

センタークロス

H	W	~80	~120	~160	~200	~240	~280	~320
~100	8,400	10,800						
~120	9,300	12,300	16,600					
~140	10,100	13,800	18,600	23,200				
~160	10,800	15,200	20,600	25,600	29,700			
~180	11,900	16,700	22,500	28,000	32,500	39,400		
~200	13,000	18,200	24,500	29,900	36,400	42,800	49,300	
~220	14,000	19,600	26,500	32,400	38,100	46,200	52,300	
~240	15,100	21,100	28,400	34,800	40,900	49,600	56,100	
~260	16,200	23,900	30,400	37,100	43,800	53,100	58,600	

レースフレンジ style no.12 (タッセル含む)

H	W	~80	~120	~160	~200	~240	~280	~320
~100	12,100	15,700						
~120	13,200	17,500	23,200					
~140	14,300	19,300	25,500	31,400				
~160	15,400	21,000	27,800	34,100	39,300			
~180	16,800	22,800	30,100	36,800	42,400	51,100		
~200	18,100	24,500	32,300	39,000	46,600	54,800	62,600	
~220	19,400	26,200	34,600	41,800	48,700	58,500	65,900	
~240	20,800	28,000	36,900	44,400	51,800	62,300	70,100	
~260	22,100	31,000	39,100	47,100	54,900	66,000	72,800	

セパレーツ

H	W	~40(1P)	~50(1P)	~60(1P)
~100	10,200	12,500	13,700	
~120	11,400	14,000	15,200	
~140	12,600	15,400	16,600	
~160	13,900	16,700	18,000	
~180	15,100	18,200	19,400	
~200	16,500	19,700	20,900	
~220	17,500	21,000	22,300	
~240	18,700	22,200	23,300	
~260	20,100	23,600	24,400	

スカラップM型

ウェーブ数	3W	4W	5W	6W	7W	
80~100	13,700	16,900	20,500	25,000	32,800	37,700
~120	15,000	18,900	22,900	27,900	36,600	41,400
~140	16,400	20,600	25,000	30,500	39,900	45,800
~160	17,700	21,800	26,700	32,700	42,800	49,900
~180		23,500	28,700	35,200	46,200	54,300
~200			30,800	37,800	49,500	58,700

レースフレンジ style no.18

ウェーブ数	3W	4W	5W	6W	7W	
80~100	17,000	20,400	24,800	30,300	40,200	45,900
~120	18,300	22,400	27,300	33,100	43,900	49,600
~140	19,700	24,100	29,300	35,700	47,200	54,100
~160	21,000	25,300	31,000	37,900	50,100	58,100
~180		27,000	33,100	40,500	53,500	62,500
~200			35,200	43,100	56,900	67,000

スカラップW型

ウェーブ数	2W	3W	4W	5W	6W	7W	
80~100	10,900	13,700	16,900	20,500	25,000	32,800	37,700
~120	11,900	15,000	18,900	22,900	27,900	36,600	41,400
~140	13,000	16,400	20,600	25,000	30,500	39,900	45,800
~160		17,700	21,800	26,700	32,700	42,800	49,900
~180			23,500	28,700	35,200	46,200	54,300
~200				30,800	37,800	49,500	58,700

レースフレンジ style no.20

ウェーブ数	2W	3W	4W	5W	6W	7W	
80~100	13,300	17,000	20,400	24,800	30,300	40,200	45,900
~120	14,400	18,300	22,400	27,300	33,100	43,900	49,600
~140	15,500	19,700	24,100	29,300	35,700	47,200	54,100
~160		21,000	25,300	31,000	37,900	50,100	58,100
~180			27,000	33,100	40,500	53,500	62,500
~200				35,200	43,100	56,900	67,000

アーチ

H	W	60~100	~130	~160	~190	~240	~290	~330
80~100	10,600	13,400	16,600	20,100	24,500	32,200	36,900	
~120	11,700	14,700	18,600	22,500	27,400	35,900	40,600	
~140	12,700	16,100	20,300	24,600	30,000	39,200	45,100	
~160		17,400	21,500	26,300	32,200	42,100	49,100	
~180			23,200	28,300	34,800	45,500	53,500	
~200				30,400	37,300	48,900	58,000	

レースフレンジ style no.27

H	W	60~100	~130	~160	~190	~240	~290	~330
80~100	12,700	16,200	19,500	23,700	29,000	38,300	43,900	
~120	13,800	17,500	21,500	26,200	31,800	42,100	47,600	
~140	14,800	18,900	23,200	28,300	34,400	45,400	52,000	
~160		20,200	24,400	30,000	36,600	48,300	56,100	
~180			26,100	32,000	39,200	51,700	60	

 style no.50 バルーンプレーン

スラッグ数 H \ W	コード式					ドラム式							
	1S	2S	3S	4S	5S	1S	2S	3S	4S	5S	6S	7S	8S
100-140	36~50	~100	~150	~200	~250	40~50	~100	~150	~200	~250	~300	~350	~400
	19,700	29,200	39,500	49,800	63,200	22,700	32,200	42,500	52,800	66,200	78,400	90,500	102,600
~180	22,300	32,900	44,500	56,000	71,200	25,300	35,900	47,500	59,000	74,200	87,700	101,300	114,900
~220	25,000	36,700	49,500	62,300	79,200	28,000	39,700	52,500	65,300	82,200	97,000	112,100	127,200
~260	26,900	40,400	54,400	68,400	87,300	29,900	43,400	57,400	71,400	90,300	106,400	122,900	135,600
~300	30,400	44,200	59,400	74,600	95,300	33,400	47,200	62,400	77,600	98,300	115,600	133,800	151,800

※ 出窓の場合はコーナー1ヶ所につきコード式は3,500円、ドラム式は4,500円プラスになります。

 style no.51 バルーンフリル

スラッグ数 H \ W	コード式					ドラム式							
	1S	2S	3S	4S	5S	1S	2S	3S	4S	5S	6S	7S	8S
100-140	36~50	~100	~150	~200	~250	40~50	~100	~150	~200	~250	~300	~350	~400
	20,500	30,700	41,700	52,800	66,900	23,500	33,700	44,700	55,800	69,900	82,800	95,600	108,400
~180	23,100	34,400	46,700	59,000	74,900	26,100	37,400	49,700	62,000	77,900	92,100	106,400	120,700
~220	25,800	38,200	51,700	65,200	82,900	28,800	41,200	54,700	68,200	85,900	101,400	117,200	133,100
~260	27,700	42,000	56,700	71,400	91,000	30,700	45,000	59,700	74,400	94,000	110,800	128,100	141,400
~300	31,200	45,700	61,700	77,600	99,000	34,200	48,700	64,700	80,600	102,000	120,000	138,900	157,700

※ 出窓の場合はコーナー1ヶ所につきコード式は3,500円、ドラム式は4,500円プラスになります。

TM-54415



巾 ◇ 150cm 価格 ◇ 2,650円/m リポート ◇ タテ 6.3cm ヨコ 7.5cm 取扱い表示 ◇ リ-30
 組成 ◇ ポリエステル100% 寸法変化率 ◇ 水洗い/タテ -0.3% ヨコ 0.0% 防炎性能 ◇ (イ)
 ドライ/タテ 0.0% ヨコ -0.5% Made in Japan

標準仕様		レギュラー縫製仕様価格表 約2倍ヒダ (タッセルなし)							
H	W	~67 1巾(片開き)	~150 2巾	~225 3巾	~300 4巾	~375 5巾	~450 6巾	~525 7巾	~600 8巾
~100		6,800	13,000	19,600	25,900	32,600	38,800	45,400	51,700
~120		7,700	14,800	22,300	29,400	36,500	44,200	51,300	58,400
~140		8,600	16,600	24,600	32,600	41,000	49,000	57,000	65,500
~160		9,500	18,400	27,300	36,200	45,100	54,000	63,200	72,100
~180		9,800	20,100	29,900	39,700	49,500	59,300	69,100	78,900
~200		10,700	21,400	32,100	42,800	53,400	64,100	74,800	85,500
~220		12,100	23,700	35,600	47,200	59,300	70,900	82,800	94,400
~240		13,000	25,500	37,900	50,800	63,200	76,200	88,700	101,100
~260		13,900	27,300	40,600	54,000	67,700	81,000	94,400	107,700
~280		14,800	29,000	43,300	57,500	71,800	86,000	100,200	114,500
約1.5倍ヒダ		~88	~200	~300	~400	~500	~600	~700	~800
フラット折1倍ヒダ		~130	~260	~410	~560				

形状記憶加工価格表 約2倍ヒダ (タッセルなし)									
H	W	~67 1巾(片開き)	~150 2巾	~225 3巾	~300 4巾	~375 5巾	~450 6巾	~525 7巾	~600 8巾
~100		8,600	16,500	24,900	32,800	41,400	49,300	57,700	65,600
~120		9,800	18,800	28,300	37,300	46,400	56,100	65,100	74,200
~140		10,900	21,100	31,200	41,400	52,000	62,200	72,400	83,200
~160		12,000	23,300	34,600	45,900	57,200	68,500	80,300	91,600
~180		12,500	25,600	38,000	50,400	62,900	75,300	87,700	100,200
~200		13,600	27,200	40,700	54,300	67,800	81,400	95,000	108,500
~220		15,400	30,100	45,200	59,900	75,300	90,000	105,100	119,800
~240		16,500	32,400	48,200	64,500	80,300	96,800	112,600	128,400
~260		17,700	34,600	51,600	68,500	85,900	102,900	119,800	136,800

※片開きはW300cmまで

style no.60 プレーンシェード														
H	W	コード式					ドラム式							
		30~45	~90	~140	~190	~240	30~45	~90	~140	~190	~240	~290	~340	~390
50~100		12,800	16,900	21,500	28,300	32,900	15,800	19,900	24,500	31,300	35,900	43,100	50,600	55,400
~140		14,900	19,000	23,800	31,500	36,400	17,900	22,000	26,800	34,500	39,400	46,900	55,700	60,600
~180		16,600	20,800	25,800	34,500	39,600	19,600	23,800	28,800	37,500	42,600	50,200	59,800	64,800
~220		18,200	22,500	27,700	37,300	42,600	21,200	25,500	30,700	40,300	45,600	53,500	64,100	69,200
~260		20,200	24,500	30,000	40,500	46,100	23,200	27,500	33,000	43,500	49,100	57,000	68,900	73,900
~300		22,000	26,400	32,000	43,600	49,300	25,000	29,400	35,000	46,600	52,300	60,600	73,200	78,500

※ドラム式:仕上り巾39cm以下の場合、仕上り巾は200cmまでとなります。

スリムシェード		
H	W	コード式
50~100		18~30
~140		17,600
~180		20,200
~220		22,000
~260		24,100
~300		25,800

TM-54416



巾 ◇ 100 cm 価格 ◇ 3,400 円/m リポート ◇ タテ cm ヨコ 5.6 cm 取扱表示 ◇ リ-30 40 炎 1 2 3 4 5 6 7 8 9 10 11 12 13 14 15 16 17 18 19 20 21 22 23 24 25 26 27 28 29 30 31 32 33 34 35 36 37 38 39 40 41 42 43 44 45 46 47 48 49 50 51 52 53 54 55 56 57 58 59 60 61 62 63 64 65 66 67 68 69 70 71 72 73 74 75 76 77 78 79 80 81 82 83 84 85 86 87 88 89 90 91 92 93 94 95 96 97 98 99 100
 組成 ◇ ポリエステル100% 寸法変化率 ◇ 水洗い/タテ -0.5% ヨコ -0.5% 防炎性能 ◇ (イ) 形態安定加工
 ドライ/タテ -0.5% ヨコ -1.0% Made in Japan

H	W	~44	~100	~150	~200	~250	~300	~350	~400
		1巾(片開き)	2巾	3巾	4巾	5巾	6巾	7巾	8巾
~100		6,500	12,900	19,400	25,800	32,200	38,700	45,100	51,600
~120		7,400	14,800	22,100	29,500	36,800	44,200	51,600	58,900
~140		8,300	16,600	24,900	33,200	41,400	49,700	58,000	66,300
~160		9,200	18,400	27,600	36,800	46,000	55,200	64,400	73,600
~180		10,200	20,300	30,400	40,500	50,600	60,800	70,900	81,000
~200		11,100	22,100	33,200	44,200	55,200	66,300	77,300	88,400
~220		12,000	24,000	35,900	47,900	59,800	71,800	83,800	95,700
~240		12,900	25,800	38,700	51,600	64,400	77,300	90,200	103,100
~260		13,800	27,600	41,400	55,200	69,000	82,800	96,600	110,400
~280		14,800	29,500	44,200	58,900	73,600	88,400	103,100	117,800
約1.5倍ヒダ		~56	~120	~200	~266	~333	~400	~466	~533
フラット約1倍ヒダ		~80	~160	~260	~360	~460	~560		

H	W	~44	~100	~150	~200	~250	~300	~350	~400
		1巾(片開き)	2巾	3巾	4巾	5巾	6巾	7巾	8巾
~100		6,800	13,500	20,200	26,900	33,600	40,400	47,100	53,800
~120		7,700	15,400	23,100	30,800	38,400	46,100	53,800	61,500
~140		8,700	17,300	26,000	34,600	43,200	51,900	60,500	69,200
~160		9,600	19,200	28,800	38,400	48,000	57,600	67,200	76,800
~180		10,600	21,200	31,700	42,300	52,800	63,400	74,000	84,500
~200		11,600	23,100	34,600	46,100	57,600	69,200	80,700	92,200
~220		12,500	25,000	37,500	50,000	62,400	74,900	87,400	99,900
~240		13,500	26,900	40,400	53,800	67,200	80,700	94,100	107,600
~260		14,400	28,800	43,200	57,600	72,000	86,400	100,800	115,200
~280		15,400	30,800	46,100	61,500	76,800	92,200	107,600	122,900
約1.5倍ヒダ		~56	~120	~200	~266	~333	~400	~466	~533

※片開きはW270cmまで

H	W	~44	~100	~150	~200	~250	~300	~350	~400
		1巾(片開き)	2巾	3巾	4巾	5巾	6巾	7巾	8巾
~100		7,000	14,000	21,000	28,000	35,000	42,000	49,000	56,000
~120		8,000	16,000	24,000	32,000	40,000	48,000	56,000	64,000
~140		9,000	18,000	27,000	36,000	45,000	54,000	63,000	72,000
~160		10,000	20,000	30,000	40,000	50,000	60,000	70,000	80,000
~180		11,000	22,000	33,000	44,000	55,000	66,000	77,000	88,000
~200		12,000	24,000	36,000	48,000	60,000	72,000	84,000	96,000
~220		13,000	26,000	39,000	52,000	65,000	78,000	91,000	104,000
~240		14,000	28,000	42,000	56,000	70,000	84,000	98,000	112,000
~260		15,000	30,000	45,000	60,000	75,000	90,000	105,000	120,000
~280		16,000	32,000	48,000	64,000	80,000	96,000	112,000	128,000
約1.5倍ヒダ		~56	~120	~200	~266	~333	~400	~466	~533

※片開きはW270cmまで

TM-54417・54418

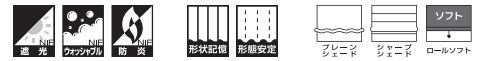

巾 ◇ 150cm 価格 ◇ 2,650円/m
組成 ◇ ポリエステル100%

リポート ◇ タテ cm ヨコ cm
寸法変化率 ◇ 水洗い/タテ 0.3% ヨコ 1.0%
ドライ/タテ -0.3% ヨコ 0.7%

取扱い表示 ◇ リ-30 40 30 30 30 30 30 30 30 30
防炎性能 ◇ (イ) あて布使用
Made in Japan

H	W	~67 1巾(片開き)	~150 2巾	~225 3巾	~300 4巾	~375 5巾	~450 6巾	~525 7巾
~100		6,700	13,300	20,000	26,600	33,300	39,900	46,600
~120		7,600	15,200	22,800	30,400	38,000	45,600	53,200
~140		8,600	17,100	25,700	34,200	42,800	51,300	59,900
~160		9,500	19,000	28,500	38,000	47,500	57,000	66,500
~180		10,500	20,900	31,400	41,800	52,300	62,700	73,200
~200		11,400	22,800	34,200	45,600	57,000	68,400	79,800
~220		12,400	24,700	37,100	49,400	61,800	74,100	86,500
~240		13,300	26,600	39,900	53,200	66,500	79,800	93,100
~260		14,300	28,500	42,800	57,000	71,300	85,500	99,800
~280		15,200	30,400	45,600	60,800	76,000	91,200	106,400
約1.5倍ヒダ		~88	~200	~300	~400	~500		

※片開きはW270cmまで

H	W	~67 1巾(片開き)	~150 2巾	~225 3巾	~300 4巾	~375 5巾	~450 6巾	~525 7巾
~100		7,100	14,200	21,300	28,300	35,400	42,500	49,500
~120		8,100	16,200	24,300	32,400	40,400	48,500	56,600
~140		9,100	18,200	27,300	36,400	45,500	54,600	63,700
~160		10,100	20,200	30,300	40,400	50,500	60,600	70,700
~180		11,200	22,300	33,400	44,500	55,600	66,700	77,800
~200		12,200	24,300	36,400	48,500	60,600	72,800	84,900
~220		13,200	26,300	39,400	52,600	65,700	78,800	92,000
~240		14,200	28,300	42,500	56,600	70,700	84,900	99,000
~260		15,200	30,300	45,500	60,600	75,800	90,900	106,100
~280		16,200	32,400	48,500	64,700	80,800	97,000	113,200
約1.5倍ヒダ		~88	~200	~300	~400	~500		

※片開きはW270cmまで

H	W	~67 1巾(片開き)	~150 2巾	~225 3巾	~300 4巾	~375 5巾	~450 6巾	~525 7巾	~600 8巾
~100		6,300	12,500	18,700	25,000	31,200	37,400	43,700	49,900
~120		7,200	14,300	21,400	28,500	35,600	42,800	49,900	57,000
~140		8,100	16,100	24,100	32,100	40,100	48,100	56,100	64,100
~160		8,900	17,800	26,700	35,600	44,500	53,400	62,300	71,200
~180		9,800	19,600	29,400	39,200	49,000	58,800	68,600	78,400
~200		10,700	21,400	32,100	42,800	53,400	64,100	74,800	85,500
~220		11,600	23,200	34,800	46,300	57,900	69,500	81,000	92,600
~240		12,500	25,000	37,400	49,900	62,300	74,800	87,300	99,700
~260		13,400	26,700	40,100	53,400	66,800	80,100	93,500	106,800
~280		14,300	28,500	42,800	57,000	71,200	85,500	99,700	114,000
約1.5倍ヒダ		~88	~200	~300	~400	~500	~600	~700	~800
フラット前ヒダ		~130	~260	~410	~560				

H	W	~67 1巾(片開き)	~150 2巾	~225 3巾	~300 4巾	~375 5巾	~450 6巾	~525 7巾	~600 8巾
~100		8,000	15,900	23,800	31,700	39,600	47,500	55,400	63,300
~120		9,100	18,100	27,200	36,200	45,200	54,300	63,300	72,400
~140		10,200	20,400	30,600	40,700	50,900	61,100	71,200	81,400
~160		11,300	22,600	33,900	45,200	56,500	67,800	79,100	90,400
~180		12,500	24,900	37,300	49,800	62,200	74,600	87,100	99,500
~200		13,600	27,200	40,700	54,300	67,800	81,400	95,000	108,500
~220		14,700	29,400	44,100	58,800	73,500	88,200	102,900	117,600
~240		15,900	31,700	47,500	63,300	79,100	95,000	110,800	126,600
~260		17,000	33,900	50,900	67,800	84,800	101,700	118,700	135,600

※片開きはW300cmまで

		コード式				ドラム式								
H	W	30~45	~90	~140	~190	~240	30~45	~90	~140	~190	~240	~290	~340	~390
50~100		12,800	16,900	21,500	28,300	32,900	15,800	19,900	24,500	31,300	35,900	43,100	50,600	55,400
~140		14,700	18,800	23,500	31,300	36,200	17,700	21,800	26,500	34,300	39,200	46,700	55,200	60,100
~180		16,400	20,600	25,600	34,300	39,400	19,400	23,600	28,600	37,300	42,400	50,000	59,500	64,500
~220		18,200	22,500	27,700	37,300	42,600	21,200	25,500	30,700	40,300	45,600	53,500	64,100	69,200
~260		19,900	24,300	29,700	40,300	45,800	22,900	27,300	32,700	43,300	48,800	56,800	68,600	73,600
~300		21,700	26,200	31,800	43,300	49,100	24,700	29,200	34,800	46,300	52,100	60,300	73,000	78,300

※ドラム式: 仕上り巾39cm以下の場合、仕上り丈は200cmまでとなります。

		コード式	
H	W	18~30	~390
50~100		17,600	
~140		19,900	
~180		21,800	
~220		24,100	
~240		25,600	

		コード式				ドラム式								
H	W	30~45	~90	~140	~190	~240	30~45	~90	~140	~190	~240	~290	~340	~390
50~100		15,600	21,900	28,500	37,900	44,300	18,600	24,900	31,500	40,900	47,300	55,500	64,900	71,500
~140		17,600	24,300	31,400	42,300	49,200	20,600	27,300	34,400	45,300	52,200	60,800	71,500	78,400
~180		19,600	26,700	34,300	46,600	54,100	22,600	29,700	37,300	49,600	57,100	66,000	78,300	85,600
~220		21,600	29,100	37,200	50,900	59,000	24,600	32,100	40,200	53,900	62,000	71,300	84,700	92,300
~260		23,700	31,800	40,500	55,800	64,600	26,700	34,800	43,500	58,800	67,600	77,400	92,200	100,400
~300		25,800	34,500	43,800	60,600	70,200	28,800	37,500	46,800	63,600	73,200	83,500	99,800	108,400

※ドラム式: 仕上り巾39cm以下の場合、仕上り丈は200cmまでとなります。

		38mm (片開き/タッセルなし)					
H	W	~72	~100	~127	~155	~183	
~100		13,100	19,800	24,000	26,100	32,900	
~140		14,400	22,500	26,700	28,800	36,900	
~180		15,800	25,200	29,400	31,500	40,900	
~220		17,100	27,800	32,000	34,100	44,800	
~260		18,400	30,500	34,700	36,800	48,800	
~300		19,700	33,100	37,300	39,400	52,800	
26mm		-2,800	-2,100	-4,900	-4,200	-4,900	
18mm		-4,900	-5,600	-9,100	-9,800	-10,500	

※生地を伸ばした状態のサイズでご発注ください。

		スプリング・チェーンタイプ				
H	W	30~60	~80	~100	~120	~140
50~80		28,400	30,900	32,900	34,100	35,800
~120		30,300	33,400	35,400	36,500	38,400
~160		32,300	36,100	38,100	39,300	40,600
~200		35,300	38,300	40,500	41,700	43,000
~240			40,800	43,100	44,300	45,700

※丈は巾の3倍までが限度です。
※ロールソフト加工品は非防災品になります。

		ストレートバランス				
H	W	~100	~150	~200	~250	~300
~40		11,400	16,900	22,300	27,800	33,200

※マジックテープ仕様・裏面スポンジ付の価格になります。
※ヨコ使いにて縫製した場合の価格になります。

H	W	~100	~150	~200	~250	~300
~40		7,100	10,100	13,100	17,100	18,600

※マジックテープ仕様の価格になります。

ライナー

TM-54419~54423

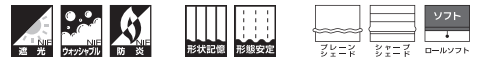

巾 ◇ 150cm 価格 ◇ 2,250円/m リポート ◇ タテ cm ヨコ cm 取扱い表示 ◇ リ-30 40 防炎性能 ◇ (イ) であて布使用
 組成 ◇ ポリエステル100% 寸法変化率 ◇ 水洗い/タテ -0.3% ヨコ 0.3% ドライ/タテ 0.0% ヨコ 0.2% Made in Japan

H	W	~67 1巾(片開き)	~150 2巾	~225 3巾	~300 4巾	~375 5巾	~450 6巾	~525 7巾
~100		6,100	12,200	18,300	24,400	30,500	36,600	42,700
~120		7,000	14,000	20,900	27,900	34,800	41,800	48,800
~140		7,900	15,700	23,500	31,400	39,200	47,000	54,900
~160		8,700	17,400	26,100	34,800	43,500	52,200	60,900
~180		9,600	19,200	28,800	38,300	47,900	57,500	67,000
~200		10,500	20,900	31,400	41,800	52,200	62,700	73,100
~220		11,400	22,700	34,000	45,300	56,600	67,900	79,200
~240		12,200	24,400	36,600	48,800	60,900	73,100	85,300
~260		13,100	26,100	39,200	52,200	65,300	78,300	91,400
~280		14,000	27,900	41,800	55,700	69,600	83,600	97,500
約1.5倍ヒダ		~88	~200	~300	~400	~500		

※片開きはW270cmまで

H	W	~67 1巾(片開き)	~150 2巾	~225 3巾	~300 4巾	~375 5巾	~450 6巾	~525 7巾
~100		6,600	13,100	19,600	26,100	32,600	39,100	45,600
~120		7,500	14,900	22,400	29,800	37,200	44,700	52,100
~140		8,400	16,800	25,200	33,500	41,900	50,300	58,600
~160		9,300	18,600	27,900	37,200	46,500	55,800	65,100
~180		10,300	20,500	30,700	41,000	51,200	61,400	71,700
~200		11,200	22,400	33,500	44,700	55,800	67,000	78,200
~220		12,100	24,200	36,300	48,400	60,500	72,600	84,700
~240		13,100	26,100	39,100	52,100	65,100	78,200	91,200
~260		14,000	27,900	41,900	55,800	69,800	83,700	97,700
~280		14,900	29,800	44,700	59,600	74,400	89,300	104,200
約1.5倍ヒダ		~88	~200	~300	~400	~500		

※片開きはW270cmまで

H	W	~67 1巾(片開き)	~150 2巾	~225 3巾	~300 4巾	~375 5巾	~450 6巾	~525 7巾	~600 8巾
~100		5,700	11,400	17,100	22,700	28,400	34,100	39,700	45,400
~120		6,500	13,000	19,500	26,000	32,400	38,900	45,400	51,900
~140		7,300	14,600	21,900	29,200	36,500	43,800	51,100	58,400
~160		8,100	16,200	24,300	32,400	40,500	48,600	56,700	64,800
~180		9,000	17,900	26,800	35,700	44,600	53,500	62,400	71,300
~200		9,800	19,500	29,200	38,900	48,600	58,400	68,100	77,800
~220		10,600	21,100	31,600	42,200	52,700	63,200	73,800	84,300
~240		11,400	22,700	34,100	45,400	56,700	68,100	79,400	90,800
~260		12,200	24,300	36,500	48,600	60,800	72,900	85,100	97,200
~280		13,000	26,000	38,900	51,900	64,800	77,800	90,800	103,700
約1.5倍ヒダ		~88	~200	~300	~400	~500	~600	~700	~800
フラット前1倍ヒダ		~130	~260	~410	~560				

H	W	~67 1巾(片開き)	~150 2巾	~225 3巾	~300 4巾	~375 5巾	~450 6巾	~525 7巾	~600 8巾
~100		7,400	14,700	22,100	29,400	36,800	44,100	51,500	58,800
~120		8,400	16,800	25,200	33,600	42,000	50,400	58,800	67,200
~140		9,500	18,900	28,400	37,800	47,300	56,700	66,200	75,600
~160		10,500	21,000	31,500	42,000	52,500	63,000	73,500	84,000
~180		11,600	23,100	34,700	46,200	57,800	69,300	80,900	92,400
~200		12,600	25,200	37,800	50,400	63,000	75,600	88,200	100,800
~220		13,700	27,300	41,000	54,600	68,300	81,900	95,600	109,200
~240		14,700	29,400	44,100	58,800	73,500	88,200	102,900	117,600
~260		15,800	31,500	47,300	63,000	78,800	94,500	110,300	126,000

※片開きはW300cmまで

		コード式				ドラム式								
H	W	30~45	~90	~140	~190	30~45	~90	~140	~190	~240	~290	~340	~390	
50~100		12,400	16,500	21,100	27,400	32,100	15,400	19,500	24,100	30,400	35,100	42,300	49,400	54,200
~140		14,100	18,200	23,000	30,200	35,100	17,100	21,200	26,000	33,200	38,100	45,600	53,600	58,500
~180		15,700	19,900	24,900	32,900	38,100	18,700	22,900	27,900	35,900	41,100	48,600	57,500	62,500
~220		17,400	21,600	26,800	35,700	41,000	20,400	24,600	29,800	38,700	44,000	51,800	61,600	66,700
~260		19,000	23,300	28,800	38,400	44,000	22,000	26,300	31,800	41,400	47,000	54,900	65,700	70,700
~300		20,600	25,100	30,700	41,200	47,000	23,600	28,100	33,700	44,200	50,000	58,100	69,700	75,000

※ドラム式: 仕上り巾39cm以下の場合、仕上り丈は200cmまでとなります。

		コード式
H	W	18~30
50~100		17,200
~140		19,400
~180		21,100
~220		23,400
~240		24,700

		コード式				ドラム式								
H	W	30~45	~90	~140	~190	30~45	~90	~140	~190	~240	~290	~340	~390	
50~100		15,100	21,400	28,000	37,100	43,400	18,100	24,400	31,000	40,100	46,400	54,600	63,600	70,200
~140		17,000	23,700	30,800	41,100	48,100	20,000	26,700	33,800	44,100	51,100	59,600	69,800	76,600
~180		18,900	26,000	33,500	45,200	52,700	21,900	29,000	36,500	48,200	55,700	64,600	76,200	83,500
~220		20,700	28,300	36,300	49,200	57,300	23,700	31,300	39,300	52,200	60,300	69,600	82,100	89,800
~260		22,700	30,800	39,500	53,800	62,600	25,700	33,800	42,500	56,800	65,600	75,400	89,200	97,300
~300		24,700	33,400	42,600	58,300	67,900	27,700	36,400	45,600	61,300	70,900	81,200	96,300	104,900

※ドラム式: 仕上り巾39cm以下の場合、仕上り丈は200cmまでとなります。

		(片開き/タッセルなし)				
H	W	~72	~100	~127	~155	~183
~100		12,600	18,900	23,100	25,200	31,500
~140		13,800	21,300	25,500	27,600	35,100
~180		15,000	23,700	27,900	30,000	38,700
~220		16,200	26,100	30,300	32,400	42,300
~260		17,400	28,500	32,700	34,800	45,900
~300		18,600	30,900	35,100	37,200	49,500
26mm		-2,800	-2,100	-4,900	-4,200	-4,900
18mm		-4,900	-5,600	-9,100	-9,800	-10,500

※生地を伸ばした状態のサイズでご発注ください。

		スプリング・チェーンタイプ				
H	W	30~60	~80	~100	~120	~140
50~80		28,000	30,500	32,500	33,700	35,400
~120		29,800	32,900	34,900	36,000	37,900
~160		31,600	35,400	37,400	38,600	39,900
~200		34,600	37,600	39,800	41,000	42,300
~240			39,900	42,200	43,400	44,800

※丈は巾の3倍までが限度です。
 ※ロールソフト加工品は非防炎品になります。

		ストレートバランス				
H	W	~100	~150	~200	~250	~300
~40		11,000	16,300	21,600	26,900	32,200

※マジックテープ仕様・裏面スポンジ付の価格になります。
 ※ヨコ使いにて縫製した場合の価格になります。

H	W	~100	~150	~200	~250	~300
~40		6,700	9,400	12,200	15,900	17,400

※マジックテープ仕様の価格になります。

TM-54424~54428



巾 ◇ 143 cm 価格 ◇ 4,100円/m
 組成 ◇ ポリエステル100%
 裏面：ポリウレタンラミネート100%

リピート ◇ タテ cm ヨコ cm
 寸法変化率 ◇ 水洗い/タテ -0.4% ヨコ -0.1%
 ドライ/タテ -0.3% ヨコ -0.1%

取扱い表示 ◇ エ-17
 防炎性能 ◇ (イ)
 Made in Japan

標準仕様		バックコーティング縫製仕様価格表 約2倍ヒダ (タッセルなし)							
H	W	~62 1巾(片開き)	~143 2巾	~214 3巾	~286 4巾	~357 5巾	~429 6巾	~500 7巾	~572 8巾
~100		9,800	19,500	29,300	39,000	48,700	58,500	68,200	78,000
~120		11,200	22,400	33,500	44,700	55,600	66,800	78,000	89,100
~140		12,600	25,000	37,600	50,200	62,700	75,100	87,700	100,300
~160		14,000	27,800	41,800	55,600	69,600	83,600	97,400	111,400
~180		15,300	30,700	45,900	61,300	76,500	92,000	107,200	122,600
~200		16,700	33,500	50,200	66,800	83,600	100,300	116,900	133,800
~220		18,100	36,200	54,400	72,500	90,500	108,600	126,700	144,700
~240		19,500	39,000	58,500	78,000	97,400	116,900	136,400	155,900
~260		20,900	41,800	62,700	83,600	104,500	125,200	146,100	167,000
~280		22,400	44,700	66,800	89,100	111,400	133,800	155,900	178,200
約1.5倍ヒダ		~78	~184	~286	~381	~476	~572	~667	~762

TM-54429~54436



巾 ◇ 220 cm ヨコ使い 価格 ◇ 3,500円/m
 組成 ◇ ポリエステル100%

リピート ◇ タテ cm ヨコ cm
 寸法変化率 ◇ 水洗い/タテ -0.5% ヨコ -0.5%
 ドライ/タテ 0.0% ヨコ -0.5%

取扱い表示 ◇ リ-31
 防炎性能 ◇ (イ)
 Made in Japan

※少なくとも月1回は洗濯をしてください

おすすめ縫製		シャワーカーテン縫製仕様価格表 約1倍ヒダ (タッセルなし)				
H	W	~100	~150	~200	~250	~300
~200		9,300	12,600	15,900	19,200	22,400

ハトムシ(9mm)仕様/ヒダなしカーテン/片開き
 ※巾方向を丈として使用しますので、巾つなぎの必要がなく美しく仕上がります。
 ※左右・裾は折り返しのない超音波加工を施しています。
 ※レギュラー縫製とは納期が異なります。

レギュラー縫製仕様価格表 約2倍ヒダ (タッセルなし)						
H	W	~100	~150	~200	~250	~300
~180		12,900	19,100	25,200	31,300	37,500
約1.5倍ヒダ		~120	~200	~266	~333	~400

※巾方向を丈として使用しますので、巾つなぎの必要がなく美しく仕上がります。

VP ONE PRICE
3300/m²

VP ワンプライス価格表

VP ONE PRICE 3300/m² VPワンプライス 一覧表

見本帳掲載頁	品番	価格 (円/m)	巾 (cm)	リピート (cm)		組成	寸法変化率 (%)				取扱い表示	備考
				タテ	ヨコ		水洗い		ドライ			
							タテ	ヨコ	タテ	ヨコ		
7	TM-VP101・VP102	4,950	150	33.0	50.0	ポリエステル100%	0.0	-0.2	-0.5	-0.5	リ-30	ウォッシュャブル
12	TM-VP103・VP104	4,950	150	—	—	ポリエステル100%	-0.2	0.0	0.0	-0.2	リ-30	ウォッシュャブル
13	TM-VP105・VP106	4,950	150	34.7	25.0	ポリエステル100%	-1.0	-0.5	-1.0	-0.5	リ-30	ウォッシュャブル
15	TM-VP107・VP108	4,950	150	36.5	25.0	ポリエステル100%	-0.3	-0.5	0.0	-0.5	リ-30	ウォッシュャブル
17	TM-VP109・VP110	4,950	150	19.2	25.0	ポリエステル100%	-0.5	-0.2	-0.5	-0.5	リ-30	ウォッシュャブル
18	TM-VP111・VP112	4,950	150	19.5	24.8	ポリエステル100%	0.0	0.0	0.0	0.0	リ-30	ウォッシュャブル
20	TM-VP113～VP116	4,950	150	19.2	10.0	ポリエステル100%	0.0	0.0	-0.5	0.0	リ-30	ウォッシュャブル
33	TM-VP117・VP118	4,950	150	—	—	ポリエステル100%	-0.7	-0.2	-0.5	-0.3	リ-30	ウォッシュャブル
36	TM-VP119・VP120	4,950	150	—	10.0	ポリエステル100%	-1.0	-0.5	0.0	-0.8	リ-30	遮光・ウォッシュャブル
39	TM-VP121・VP122	4,950	150	54.5	25.0	ポリエステル100%	0.0	-0.2	-1.0	-0.8	リ-30	ウォッシュャブル
41	TM-VP123・VP124	4,950	150	33.0	50.0	ポリエステル100%	-0.5	-0.5	-0.5	-0.5	リ-30	ウォッシュャブル
45	TM-VP125・VP126	4,950	150	—	—	タテ：ポリエステル100% ヨコ：ポリエステル71% 綿29%	-1.0	0.2	-0.7	-0.2	リ-30	ウォッシュャブル
48	TM-VP127・VP128	4,950	150	51.0	51.0	ポリエステル100%	0.0	0.0	-0.5	0.0	リ-30	ウォッシュャブル
49	TM-VP129・VP130	4,950	150	8.7	15.0	ポリエステル100%	0.0	0.0	-0.5	-0.5	リ-30	ウォッシュャブル
50	TM-VP131・VP132	4,950	150	37.0	25.5	ポリエステル100%	-0.5	0.0	-0.5	0.0	リ-30	ウォッシュャブル
80	TM-VP133・VP134	4,950	150	25.5	7.5	ポリエステル100%	0.0	0.0	-0.5	0.0	リ-30	ウォッシュャブル
93	TM-VP135・VP136	4,950	150	41.5	24.9	ポリエステル100%	-0.5	-0.5	-0.7	-0.3	リ-30	ウォッシュャブル
95	TM-VP137・VP138	4,950	150	33.3	18.8	ポリエステル100%	0.0	0.0	-0.5	0.0	リ-30	ウォッシュャブル
115	TM-VP139～VP142	4,950	150	—	—	ポリエステル100%	0.0	0.0	0.0	0.0	リ-30	ウォッシュャブル
137	TM-VP143・VP144	4,950	150	37.5	25.0	ポリエステル100%	-0.5	0.0	-0.8	-0.8	リ-30	ウォッシュャブル
147	TM-VP145～VP147	4,950	150	32.5	30.0	ポリエステル100%	-0.5	-0.2	-0.5	0.0	リ-30	遮光・ウォッシュャブル
151	TM-VP148～VP150	4,950	150	—	—	ポリエステル100%	0.0	0.0	0.0	-0.5	リ-30	遮光・ウォッシュャブル
172	TM-VP151・VP152	4,950	150	1.8	1.5	ポリエステル100%	-0.3	-0.2	-0.5	-0.2	リ-30	遮光・ウォッシュャブル
173	TM-VP153・VP154	4,950	150	1.0	1.0	ポリエステル100%	-0.3	-0.5	-0.5	-1.0	リ-30	遮光・ウォッシュャブル
174	TM-VP155・VP156	4,950	150	14.5	—	ポリエステル100%	0.0	-0.2	0.0	0.2	リ-30	遮光・ウォッシュャブル
176	TM-VP157・VP158	4,950	150	—	—	ポリエステル100%	-0.5	0.0	-0.5	-0.5	リ-30	遮光・ウォッシュャブル

※ P.260に対応価格表の掲載があります。

品番	防災ラベル表示	生産国	対応価格表※																		
			形態安定加工	プライム縫製	レギュラー縫製	形状記憶加工	ブレンシエード	シャープシエード	スリムシエード	ロールソフト	センタークロス		セパレーツ	スカラップM型		スカラップW型		アーチ		バルーンブレイン	バルーンフリル
											共生地フリル	レースフレンジ		共生地フリル	レースフレンジ	共生地フリル	レースフレンジ	共生地フリル	レースフレンジ		
TM-VP101・VP102	イ	日本製	●	●	●	●	●	●	●	●											
TM-VP103・VP104	ー	日本製	●	●	●	●	●	●	●	●											
TM-VP105・VP106	イ	日本製	●	●	●	●	●	●	●	●											
TM-VP107・VP108	ー	日本製	●	●	●	●	●	●	●	●											
TM-VP109・VP110	ー	日本製	●	●	●	●	●	●	●	●											
TM-VP111・VP112	ー	日本製	●	●	●	●	●	●	●	●											
TM-VP113～VP116	ー	日本製	●	●	●	●	●	●	●	●											
TM-VP117・VP118	ー	日本製	●	●	●	●	●	●	●	●											
TM-VP119・VP120	ー	日本製	●	●	●	●	●	●	●	●											
TM-VP121・VP122	イ	日本製	●	●	●	●	●	●	●	●											
TM-VP123・VP124	ー	日本製	●	●	●	●	●	●	●	●											
TM-VP125・VP126	ー	日本製	●	●	●		●	●		●											
TM-VP127・VP128	ー	日本製	●	●	●	●	●	●	●	●											
TM-VP129・VP130	イ	日本製	●	●	●	●	●	●	●	●											
TM-VP131・VP132	ー	日本製	●	●	●	●	●	●	●	●											
TM-VP133・VP134	ー	日本製	●	●	●	●	●	●	●												
TM-VP135・VP136	ー	日本製	●	●	●	●	●	●	●	●											
TM-VP137・VP138	ー	日本製	●	●	●	●	●	●	●	●											
TM-VP139～VP142	ー	日本製	●	●	●	●	●	●	●	●											
TM-VP143・VP144	ー	日本製	●	●	●	●	●	●	●	●											
TM-VP145～VP147	ー	日本製	●	●	●	●	●	●	●	●											
TM-VP148～VP150	ー	日本製	●	●	●	●	●	●	●	●											
TM-VP151・VP152	ー	日本製	●	●	●	●	●	●	●	●											
TM-VP153・VP154	ー	日本製	●	●	●	●	●	●	●	●											
TM-VP155・VP156	イ	日本製	●	●	●	●	●	●	●	●											
TM-VP157・VP158	ー	日本製	●	●	●	●	●	●	●	●											

VP
ワンピース価格表

標準仕様 形態安定加工価格表 約2倍ヒダ (タッセル含む)

H	W	~67 1巾(片開き)	~150 2巾	~225 3巾	~300 4巾	~375 5巾	~450 6巾	~525 7巾
~100		12,800	25,600	36,900	48,100	59,400	70,700	82,000
~120		14,200	28,400	41,100	53,800	66,500	79,200	91,900
~140		15,600	31,200	45,300	59,400	73,500	87,600	101,700
~160		17,000	34,000	49,600	65,100	80,600	96,100	111,600
~180		18,500	36,900	53,800	70,700	87,600	104,500	121,500
~200		19,900	39,700	58,000	76,300	94,700	113,000	131,300
~220		21,300	42,500	62,200	82,000	101,700	121,500	141,200
~240		22,700	45,300	66,500	87,600	108,800	129,900	151,100
~260		24,100	48,100	70,700	93,300	115,800	138,400	160,900
~280		25,500	51,000	74,900	98,900	122,900	146,800	170,800
約1.5倍ヒダ		~88	~200	~300	~400	~500		

※片開きはW270cmまで

プライム縫製仕様価格表 約2倍ヒダ (タッセル含む)

H	W	~67 1巾(片開き)	~150 2巾	~225 3巾	~300 4巾	~375 5巾	~450 6巾	~525 7巾
~100		13,300	26,500	38,300	50,100	61,800	73,600	85,300
~120		14,800	29,500	42,700	55,900	69,200	82,400	95,600
~140		16,200	32,400	47,100	61,800	76,500	91,200	105,900
~160		17,700	35,400	51,500	67,700	83,900	100,000	116,200
~180		19,200	38,300	55,900	73,600	91,200	108,900	126,500
~200		20,600	41,200	60,400	79,500	98,600	117,700	136,800
~220		22,100	44,200	64,800	85,300	105,900	126,500	147,100
~240		23,600	47,100	69,200	91,200	113,300	135,300	157,400
~260		25,100	50,100	73,600	97,100	120,600	144,100	167,700
~280		26,500	53,000	78,000	103,000	128,000	153,000	178,000
約1.5倍ヒダ		~88	~200	~300	~400	~500		

※片開きはW270cmまで

レギュラー縫製仕様価格表 約2倍ヒダ (タッセル含む)

H	W	~67 1巾(片開き)	~150 2巾	~225 3巾	~300 4巾	~375 5巾	~450 6巾	~525 7巾	~600 8巾
~100		12,300	24,600	35,400	46,200	57,000	67,800	78,600	89,400
~120		13,700	27,300	39,500	51,600	63,800	75,900	88,100	100,200
~140		15,000	30,000	43,500	57,000	70,500	84,000	97,500	111,000
~160		16,400	32,700	47,600	62,400	77,300	92,100	107,000	121,800
~180		17,700	35,400	51,600	67,800	84,000	100,200	116,400	132,600
~200		19,100	38,100	55,700	73,200	90,800	108,300	125,900	143,400
~220		20,400	40,800	59,700	78,600	97,500	116,400	135,300	154,200
~240		21,800	43,500	63,800	84,000	104,300	124,500	144,800	165,000
~260		23,100	46,200	67,800	89,400	111,000	132,600	154,200	175,800
~280		24,500	48,900	71,900	94,800	117,800	140,700	163,700	186,600
約1.5倍ヒダ		~88	~200	~300	~400	~500	~600	~700	~800
フラット前ヒダ		~130	~260	~410	~560				

形状記憶加工価格表 約2倍ヒダ (タッセル含む)

H	W	~67 1巾(片開き)	~150 2巾	~225 3巾	~300 4巾	~375 5巾	~450 6巾	~525 7巾	~600 8巾
~100		14,300	28,500	41,200	53,900	66,600	79,300	92,100	104,800
~120		15,800	31,600	46,000	60,300	74,600	88,900	103,200	117,500
~140		17,400	34,800	50,700	66,600	82,500	98,400	114,300	130,200
~160		19,000	38,000	55,500	73,000	90,500	108,000	125,500	142,900
~180		20,600	41,200	60,300	79,300	98,400	117,500	136,600	155,700
~200		22,200	44,400	65,000	85,700	106,400	127,000	147,700	168,400
~220		23,800	47,500	69,800	92,100	114,300	136,600	158,800	181,100
~240		25,400	50,700	74,600	98,400	122,300	146,100	170,000	193,800
~260		27,000	53,900	79,300	104,800	130,200	155,700	181,100	206,500

※片開きはW300cmまで

対応外品番 TM-VP125・126

style no.60 プレーンシェード

		コード式				ドラム式								
H	W	30~45	~90	~140	~190	~240	30~45	~90	~140	~190	~240	~290	~340	~390
50~100		15,300	19,300	23,800	32,900	37,600	18,300	22,300	26,800	35,900	40,600	47,900	57,800	62,500
~140		17,900	22,000	26,700	37,400	42,400	20,900	25,000	29,700	40,400	45,400	53,000	64,700	69,600
~180		20,500	24,500	29,600	42,000	47,100	23,500	27,500	32,600	45,000	50,100	57,900	71,400	76,400
~220		23,100	27,200	32,400	46,600	51,900	26,100	30,200	35,400	49,600	54,900	63,000	78,300	83,400
~260		25,600	29,800	35,300	51,100	56,700	28,600	32,800	38,300	54,100	59,700	67,900	85,200	90,200
~300		28,200	32,500	38,100	55,700	61,500	31,200	35,500	41,100	58,700	64,500	73,000	92,000	97,300

※ドラム式：仕上り巾39cm以下の場合、仕上り丈は200cmまでとなります。

style no.63 シャープシェード

		コード式				ドラム式								
H	W	30~45	~90	~140	~190	~240	30~45	~90	~140	~190	~240	~290	~340	~390
50~100		18,100	24,400	31,000	42,900	49,300	21,100	27,400	34,000	45,900	52,300	60,500	72,400	78,900
~140		20,900	27,600	34,700	48,900	55,900	23,900	30,600	37,700	51,900	58,900	67,400	81,400	88,300
~180		23,700	30,900	38,400	54,900	62,400	26,700	33,900	41,400	57,900	65,400	74,300	90,800	98,100
~220		26,600	34,100	42,100	60,800	69,000	29,600	37,100	45,100	63,800	72,000	81,200	99,600	107,200
~260		29,500	37,600	46,300	67,400	76,200	32,500	40,600	49,300	70,400	79,200	89,000	109,600	117,800
~300		32,500	41,200	50,400	73,900	83,500	35,500	44,200	53,400	76,900	86,500	96,700	119,600	128,300

※ドラム式：仕上り巾39cm以下の場合、仕上り丈は200cmまでとなります。

形態安定加工 推奨裏地付価格表(推奨裏地TM-54419~54423) 約2倍ヒダ (タッセル含む)

H	W	~67 1巾(片開き)	~150 2巾	~225 3巾	~300 4巾	~375 5巾	~450 6巾	~525 7巾
~100		18,900	37,800	55,200	72,500	89,900	107,300	124,700
~120		21,200	42,400	62,000	81,700	101,300	121,000	140,700
~140		23,500	46,900	68,800	90,800	112,700	134,600	156,600
~160		25,700	51,400	75,700	99,900	124,100	148,300	172,500
~180		28,100	56,100	82,600	109,000	135,500	162,000	188,500
~200		30,400	60,600	89,400	118,100	146,900	175,700	204,400
~220		32,700	65,200	96,200	127,300	158,300	189,400	220,400
~240		34,900	69,700	103,100	136,400	169,700	203,000	236,400
~260		37,200	74,200	109,900	145,500	181,100	216,700	252,300
~280		39,500	78,900	116,700	154,600	192,500	230,400	268,300
約1.5倍ヒダ		~88	~200	~300	~400	~500		

※片開きはW270cmまで

プライム縫製仕様 推奨裏地付価格表(推奨裏地TM-54419~54423) 約2倍ヒダ (タッセル含む)

H	W	~67 1巾(片開き)	~150 2巾	~225 3巾	~300 4巾	~375 5巾	~450 6巾	~525 7巾
~100		19,900	39,600	57,900	76,200	94,400	112,700	130,900
~120		22,300	44,400	65,100	85,700	106,400	127,100	147,700
~140		24,600	49,200	72,300	95,300	118,400	141,500	164,500
~160		27,000	54,000	79,400	104,900	130,400	155,800	181,300
~180		29,500	58,800	86,600	114,600	142,400	170,300	198,200
~200		31,800	63,600	93,900	124,200	154,400	184,700	215,000
~220		34,200	68,400	101,100	133,700	166,400	199,100	231,800
~240		36,700	73,200	108,300	143,300	178,400	213,500	248,600
~260		39,100	78,000	115,500	152,900	190,400	227,800	265,400
~280		41,400	82,800	122,700	162,600	202,400	242,300	282,200
約1.5倍ヒダ		~88	~200	~300	~400	~500		

※片開きはW270cmまで

レギュラー縫製仕様 推奨裏地付価格表(推奨裏地TM-54419~54423) 約2倍ヒダ (タッセル含む)

H	W	~67 1巾(片開き)	~150 2巾	~225 3巾	~300 4巾	~375 5巾	~450 6巾	~525 7巾	~600 8巾
~100		18,000	36,000	52,500	68,900	85,400	101,900	118,300	134,800
~120		20,200	40,300	59,000	77,600	96,200	114,800	133,500	152,100
~140		22,300	44,600	65,400	86,200	107,000	127,800	148,600	169,400
~160		24,500	48,900	71,900	94,800	117,800	140,700	163,700	186,600
~180		26,700	53,300	78,400	103,500	128,600	153,700	178,800	203,900
~200		28,900	57,600	84,900	112,100	139,400	166,700	194,000	221,200
~220		31,000	61,900	91,300	120,800	150,200	179,600	209,100	238,500
~240		33,200	66,200	97,900	129,400	161,000	192,600	224,200	255,800
~260		35,300	70,500	104,300	138,000	171,800	205,500	239,300	273,000
~280		37,500	74,900	110,800	146,700	182,600	218,500	254,500	290,300
約1.5倍ヒダ		~88	~200	~300	~400	~500	~600	~700	~800

対応外品番 TM-VP111・112 / 117・118 / 139~158

スリムシェード

		コード式
H	W	18~30
50~100		19,800
~140		22,90

NP ONE PRICE
2200/m²

NP ワンプライス価格表

見本帳掲載頁	品番	価格 (円/m)	巾 (cm)	リピート (cm)		組成	寸法変化率 (%)				取扱い表示	備考
				タテ	ヨコ		水洗い		ドライ			
							タテ	ヨコ	タテ	ヨコ		
61	TM-NP901・NP902	3,300	150	60.5	75.0	ポリエステル100%	-0.2	-0.3	-0.7	-0.2	リ-30	遮光・ウオッシュャブル
63	TM-NP903・NP904	3,300	150	30.3	50.0	ポリエステル100%	0.0	0.0	-0.5	0.0	リ-30	遮光・ウオッシュャブル
64	TM-NP905～NP908	3,300	150	—	—	ポリエステル100%	0.0	0.0	-1.0	0.0	リ-30	遮光・ウオッシュャブル
65	TM-NP909～NP912	3,300	150	—	—	ポリエステル100%	0.0	0.0	-0.3	0.0	リ-30	遮光・ウオッシュャブル
66	TM-NP913～NP916	3,300	150	—	—	ポリエステル100%	0.0	0.0	0.0	0.0	リ-30	ウオッシュャブル
67	TM-NP917・NP918	3,300	150	28.2	50.0	ポリエステル100%	0.0	0.0	0.0	0.0	リ-30	ウオッシュャブル
68	TM-NP919～NP925	3,300	150	—	—	ポリエステル100%	-0.3	0.0	0.0	0.0	リ-30	ウオッシュャブル
69	TM-NP926・NP927	3,300	150	32.5	25.5	タテ：ポリエステル100% ヨコ：ポリエステル68% 綿18% アクリル14%	-0.7	0.0	-0.5	-0.3	リ-30	ウオッシュャブル
70	TM-NP928・NP929	3,300	150	—	—	タテ：ポリエステル100% ヨコ：ポリエステル68% 綿18% アクリル14%	-1.0	0.0	-0.2	-0.2	リ-30	ウオッシュャブル
71	TM-NP930・NP931	3,300	150	3.5	3.1	ポリエステル100%	-0.3	0.3	-0.2	-0.2	リ-30	ウオッシュャブル
72	TM-NP932～NP934	3,300	150	21.0	25.0	ポリエステル100%	-0.2	0.0	-0.2	0.2	リ-30	ウオッシュャブル
73	TM-NP935・NP936	3,300	150	1.3	2.5	タテ：ポリエステル100% ヨコ：綿40% アクリル30% ポリエステル30%	-0.8	-1.0	-0.2	0.0	リ-30	ウオッシュャブル
74	TM-NP937～NP942	3,300	150	—	—	ポリエステル100%	-0.2	-0.7	-0.2	0.0	リ-30	ウオッシュャブル

※ P.264に対応価格表の掲載があります。

品番	防災ラベル表示	生産国	対応価格表※																			
			形態安定加工	プライム縫製	レギュラー縫製	形状記憶加工	ブレインシールド	シャープシールド	スリムシールド	ロールソフト	センタークロス		セパレーツ	スカラップM型		スカラップW型		アーチ		バルーンブレイン	バルーンフリル	
											共生地フリル	レースフレンジ		共生地フリル	レースフレンジ	共生地フリル	レースフレンジ	共生地フリル	レースフレンジ			
TM-NP901・NP902	—	日本製	●	●	●	●	●	●	●	●												
TM-NP903・NP904	—	日本製	●	●	●	●	●	●	●	●												
TM-NP905～NP908	—	日本製	●	●	●	●	●	●	●	●												
TM-NP909～NP912	—	日本製	●	●	●	●	●	●	●	●												
TM-NP913～NP916	—	日本製	●	●	●	●	●	●	●	●												
TM-NP917・NP918	—	日本製	●	●	●	●	●	●	●	●												
TM-NP919～NP925	—	台湾製	●	●	●	●	●	●	●	●												
TM-NP926・NP927	—	日本製	●	●	●		●	●		●												
TM-NP928・NP929	—	日本製	●	●	●		●	●		●												
TM-NP930・NP931	—	日本製	●	●	●	●	●			●	●											
TM-NP932～NP934	—	日本製	●	●	●	●	●	●	●	●												
TM-NP935・NP936	—	日本製	●	●	●		●	●		●												
TM-NP937～NP942	—	日本製	●	●	●	●	●	●	●	●												

標準仕様		形態安定加工価格表 約2倍ヒダ (タッセル含む)						
H	W	~67 1巾(片開き)	~150 2巾	~225 3巾	~300 4巾	~375 5巾	~450 6巾	~525 7巾
~100		9,800	19,600	28,300	36,900	45,600	54,200	62,800
~120		10,900	21,800	31,500	41,200	51,000	60,700	70,400
~140		12,000	24,000	34,800	45,600	56,400	67,200	78,000
~160		13,100	26,100	38,000	49,900	61,800	73,600	85,500
~180		14,200	28,300	41,200	54,200	67,200	80,100	93,100
~200		15,200	30,400	44,500	58,500	72,600	86,600	100,600
~220		16,300	32,600	47,700	62,800	78,000	93,100	108,200
~240		17,400	34,800	51,000	67,200	83,400	99,600	115,800
~260		18,500	36,900	54,200	71,500	88,800	106,000	123,300
~280		19,600	39,100	57,400	75,800	94,200	112,500	130,900
約1.5倍ヒダ		~88	~200	~300	~400	~500		

※片開きはW270cmまで

レギュラー縫製仕様価格表 約2倍ヒダ (タッセル含む)									
H	W	~67 1巾(片開き)	~150 2巾	~225 3巾	~300 4巾	~375 5巾	~450 6巾	~525 7巾	~600 8巾
~100		9,400	18,700	26,800	35,000	43,200	51,300	59,500	67,600
~120		10,400	20,700	29,900	39,100	48,300	57,400	66,600	75,800
~140		11,400	22,800	33,000	43,200	53,400	63,600	73,800	84,000
~160		12,400	24,800	36,000	47,200	58,500	69,700	80,900	92,100
~180		13,400	26,800	39,100	51,300	63,600	75,800	88,000	100,300
~200		14,500	28,900	42,100	55,400	68,700	81,900	95,200	108,400
~220		15,500	30,900	45,200	59,500	73,800	88,000	102,300	116,600
~240		16,500	33,000	48,300	63,600	78,900	94,200	109,500	124,800
~260		17,500	35,000	51,300	67,600	84,000	100,300	116,600	132,900
~280		18,500	37,000	54,400	71,700	89,100	106,400	123,700	141,100
約1.5倍ヒダ		~88	~200	~300	~400	~500	~600	~700	~800
フラット約1倍ヒダ		~130	~260	~410	~560				

style no.60 プレーンシェード														
		コード式				ドラム式								
H	W	30~45	~90	~140	~190	~240	30~45	~90	~140	~190	~240	~290	~340	~390
50~100		13,500	17,600	22,100	29,600	34,200	16,500	20,600	25,100	32,600	37,200	44,500	52,700	57,400
~140		15,600	19,700	24,400	33,000	38,000	18,600	22,700	27,400	36,000	41,000	48,400	57,900	62,800
~180		17,600	21,700	26,700	36,500	41,600	20,600	24,700	29,700	39,500	44,600	52,200	62,900	67,900
~220		19,600	23,800	29,000	39,900	45,300	22,600	26,800	32,000	42,900	48,300	56,200	68,100	73,200
~260		21,500	25,900	31,300	43,400	48,900	24,500	28,900	34,300	46,400	51,900	59,900	73,300	78,300
~300		23,600	28,000	33,600	46,800	52,600	26,600	31,000	36,600	49,800	55,600	63,900	78,300	83,700

※ドラム式: 仕上り巾39cm以下の場合、仕上り丈は200cmまでとなります。

style no.63 シャープシェード														
		コード式				ドラム式								
H	W	30~45	~90	~140	~190	~240	30~45	~90	~140	~190	~240	~290	~340	~390
50~100		16,300	22,600	29,200	39,400	45,700	19,300	25,600	32,200	42,400	48,700	56,900	67,000	73,600
~140		18,500	25,200	32,300	44,100	51,100	21,500	28,200	35,300	47,100	54,100	62,600	74,300	81,200
~180		20,700	27,900	35,400	48,900	56,500	23,700	30,900	38,400	51,900	59,500	68,400	81,900	89,100
~220		23,000	30,500	38,600	53,700	61,900	26,000	33,500	41,600	56,700	64,900	74,100	88,900	96,600
~260		25,300	33,500	42,100	59,100	67,900	28,300	36,500	45,100	62,100	70,900	80,700	97,100	105,300
~300		27,700	36,400	45,700	64,400	74,000	30,700	39,400	48,700	67,400	77,000	87,200	105,400	114,000

※ドラム式: 仕上り巾39cm以下の場合、仕上り丈は200cmまでとなります。

対応外品番 TM-NP930・931

style no.501 ロールソフト						
		スプリング・チェーンタイプ				
H	W	30~60	~80	~100	~120	~140
50~80		29,000	31,500	33,500	34,700	36,400
~120		31,200	34,300	36,300	37,400	39,300
~160		33,300	37,100	39,100	40,300	41,600
~200		36,600	39,600	41,800	43,000	44,300
~240			42,200	44,500	45,700	47,100

※丈は巾の3倍までが限度です。
※ロールソフト加工品は非防炎品になります。

プライム縫製仕様価格表 約2倍ヒダ (タッセル含む)								
H	W	~67 1巾(片開き)	~150 2巾	~225 3巾	~300 4巾	~375 5巾	~450 6巾	~525 7巾
~100		10,300	20,600	29,700	38,800	48,000	57,100	66,200
~120		11,500	22,900	33,100	43,400	53,700	63,900	74,200
~140		12,600	25,200	36,600	48,000	59,400	70,800	82,200
~160		13,700	27,400	40,000	52,500	65,100	77,600	90,100
~180		14,900	29,700	43,400	57,100	70,800	84,400	98,100
~200		16,000	32,000	46,800	61,600	76,500	91,300	106,100
~220		17,200	34,300	50,200	66,200	82,200	98,100	114,100
~240		18,300	36,600	53,700	70,800	87,900	105,000	122,100
~260		19,400	38,800	57,100	75,300	93,600	111,800	130,000
~280		20,600	41,100	60,500	79,900	99,300	118,600	138,000
約1.5倍ヒダ		~88	~200	~300	~400	~500		

※片開きはW270cmまで

形状記憶加工価格表 約2倍ヒダ (タッセル含む)									
H	W	~67 1巾(片開き)	~150 2巾	~225 3巾	~300 4巾	~375 5巾	~450 6巾	~525 7巾	~600 8巾
~100		11,300	22,500	32,600	42,700	52,800	62,800	72,900	83,000
~120		12,500	25,000	36,400	47,700	59,100	70,400	81,700	93,100
~140		13,800	27,600	40,200	52,800	65,400	78,000	90,600	103,200
~160		15,100	30,100	43,900	57,800	71,700	85,500	99,400	113,200
~180		16,300	32,600	47,700	62,800	78,000	93,100	108,200	123,300
~200		17,600	35,100	51,500	67,900	84,300	100,600	117,000	133,400
~220		18,800	37,600	55,300	72,900	90,600	108,200	125,800	143,500
~240		20,100	40,200	59,100	78,000	96,900	115,800	134,700	153,600
~260		21,400	42,700	62,800	83,000	103,200	123,300	143,500	163,600

※片開きはW300cmまで

対応外品番 TM-NP926~929 / 935・936

スリムシェード			
		コード式	
H	W	18~30	
50~100		18,200	
~140		20,800	
~180		22,800	
~220		25,400	
~240		26,900	

対応外品番 TM-NP926~929 / 935・936

ハトメカーテン 約1.8倍ヒダ							
		38mm (片開き/タッセルなし)					
H	W	~72	~100	~127	~155	~183	
~100		13,800	21,300	25,500	27,600	35,100	
~140		15,400	24,400	28,600	30,700	39,700	
~180		16,900	27,400	31,600	33,700	44,300	
~220		18,400	30,500	34,700	36,800	48,900	
~260		20,000	33,600	37,800	39,900	53,500	
~300		21,500	36,700	40,900	43,000	58,100	
26mm		-2,800	-2,100	-4,900	-4,200	-4,900	
18mm		-4,900	-5,600	-9,100	-9,800	-10,500	

※生地を伸ばした状態のサイズでご発注ください。

バランス						
		ストレートバランス				
H	W	~100	~150	~200	~250	~300
~40		10,400	16,400	20,800	25,200	31,200

※マジックテープ仕様・裏面スポンジ付の価格になります。

三つ山・箱ヒダバランス (約2.5倍ヒダ)						
H	W	~100	~150	~200	~250	~300
~40		7,800	11,200	14,500	18,900	20,400

※マジックテープ仕様の価格になります。

ラインビュー クラシックコレクション

STR21~26・28~30 **特殊掛率**



組成 ◇ ポリエステル100%

取扱い表示 ◇
Made in Japan 洗濯ネット使用

&time 見本帳 265 ページ掲載

※価格表・仕様等、詳しい説明は14・15ページをご覧ください。

ラインビュー kioi インクジェットプリント

STR71 菊松葉尽くし・STR72 野の草花文様 **受注生産** **特殊掛率**



組成 ◇ ポリエステル100%

取扱い表示 ◇
Made in Japan 洗濯ネット使用

&time 見本帳 266 ページ掲載

※価格表・仕様等、詳しい説明は14・15ページをご覧ください。

アートレース ゆらぎ

54442Y~54444Y スタイル掛率適用品 / 縫製加工販売品



&time 見本帳 267・268 ページ掲載 / Néo 15・16 ページ掲載

AY01 アートレース ゆらぎ (形態安定加工)

		(約2倍ヒダ/タッセルなし)					
H	W	~100 1巾(片開き)	~200 2巾	~300 3巾	~400 4巾	~500 5巾	~600 6巾
~120	6,800	13,600	20,400	27,200	34,000	40,800	
~140	7,700	15,300	22,900	30,500	38,100	45,700	
~160	8,500	17,000	25,400	33,900	42,400	50,800	
~180	9,300	18,600	27,900	37,200	46,500	55,700	
~200	10,200	20,300	30,500	40,600	50,700	60,900	
~220	11,000	22,000	33,000	44,000	55,000	66,000	
~240	11,900	23,700	35,500	47,300	59,100	71,000	
~260	12,700	25,400	38,100	50,700	63,400	76,100	
~280	13,600	27,100	40,600	54,200	67,700	81,200	
~300	14,400	28,800	43,100	57,500	71,800	86,200	
約1.5倍ヒダ	~120	~260	~400	~530	~660	~800	

※片開きは2倍ヒダでW300まで/1.5倍ヒダでW400まで

AY02 アートレース ゆらぎ (レギュラー)

		(約2倍ヒダ/タッセルなし)					
H	W	~100 1巾(片開き)	~200 2巾	~300 3巾	~400 4巾	~500 5巾	~600 6巾
~120	6,300	12,600	18,900	25,200	31,400	37,700	
~140	7,100	14,200	21,200	28,300	35,300	42,400	
~160	7,900	15,700	23,600	31,400	39,200	47,100	
~180	8,700	17,300	25,900	34,500	43,100	51,800	
~200	9,400	18,800	28,200	37,600	47,000	56,400	
~220	10,200	20,400	30,600	40,800	50,900	61,100	
~240	11,000	22,000	33,000	44,000	55,000	66,000	
~260	11,800	23,600	35,400	47,200	58,900	70,700	
~280	12,600	25,200	37,700	50,300	62,800	75,400	
~300	13,400	26,700	40,100	53,400	66,700	80,100	
約1.5倍ヒダ	~120	~260	~400	~530	~660	~800	

AY03 アートレース ゆらぎ (形状記憶)

		(約2倍ヒダ/タッセルなし)					
H	W	~100 1巾(片開き)	~200 2巾	~300 3巾	~400 4巾	~500 5巾	~600 6巾
~120	7,600	15,200	22,700	30,300	37,900	45,400	
~140	8,600	17,100	25,600	34,100	42,600	51,100	
~160	9,500	18,900	28,400	37,800	47,200	56,700	
~180	10,400	20,800	31,200	41,500	51,900	62,300	
~200	11,400	22,700	34,000	45,300	56,600	67,900	
~220	12,300	24,500	36,800	49,000	61,300	73,500	
~240	13,300	26,500	39,700	52,900	66,200	79,400	
~260	14,200	28,400	42,500	56,700	70,800	85,000	
~280	15,100	30,200	45,300	60,400	75,500	90,600	
~300	16,100	32,100	48,100	64,200	80,200	96,200	
約1.5倍ヒダ	~120	~260	~400	~530	~660	~800	

※片開きは2倍ヒダでW300まで/1.5倍ヒダでW400まで

AY04 アートレース ゆらぎ (フラットカーテン)

		(約1倍ヒダ/タッセルなし)			
H	W	~160 1巾	~360 2巾	~580 3巾	~760 4巾
~120	7,000	13,900	20,800	27,700	
~140	7,800	15,600	23,300	31,100	
~160	8,700	17,300	25,900	34,500	
~180	9,500	19,000	28,500	38,000	
~200	10,400	20,700	31,100	41,400	
~220	11,200	22,400	33,600	44,800	
~240	12,100	24,200	36,200	48,300	
~260	13,000	25,900	38,800	51,700	
~280	13,800	27,600	41,400	55,100	
~300	14,700	29,300	43,900	58,500	

※片開きは1巾でW180cmまで作成可能

AYS01 アートレース ゆらぎ プレーンシェード

		コード式					ドラム式							
H	W	30~45	~90	~140	~190	~240	30~45	~90	~140	~190	~240	~290	~340	~390
50~100	13,400	17,400	22,000	26,100	33,900	16,400	20,400	25,000	29,100	36,900	44,100	48,900	53,700	
~140	15,200	19,400	24,100	28,300	37,300	18,200	22,400	27,100	31,300	40,300	47,800	52,700	57,600	
~180	17,100	21,200	26,300	30,500	40,700	20,100	24,200	29,300	33,500	43,700	51,300	56,300	61,300	
~220	19,000	23,200	28,400	32,700	44,100	22,000	26,200	31,400	35,700	47,100	54,900	60,100	65,200	
~260	20,800	25,100	30,500	34,900	47,400	23,800	28,100	33,500	37,900	50,400	58,400	63,900	68,900	
~300	22,700	27,100	32,700	37,100	50,900	25,700	30,100	35,700	40,100	53,900	62,100	67,500	72,800	

※ドラム式: 仕上り巾39cm以下の場合、仕上り丈は200cmまでとなります。

ロールスクリーン スタイル掛率適用品

&time 見本帳 270 ページ掲載 / Néο 52、128・129、131 ページ掲載

54445R・54446R

組成：ポリエステル100%



54445R・54446R

		ロールスクリーン				
		スプリングタイプ				
H	W	30~49	~80	~120	~160	~200
30~49		18,700	20,300	22,500	23,700	25,500
	~80	20,900	27,900	31,900	34,500	36,000
	~120	23,100	29,600	34,500	37,900	39,300
	~160	25,300	31,500	38,000	41,400	43,800
	~200	-	33,200	41,400	45,700	47,000
	~250	-	35,500	45,200	50,000	51,300
	~300	-	-	49,200	54,300	55,500

※ 製作可能な幅：高さの比率は、1：3以下

54445R・54446R

		ロールスクリーン				
		チェーンタイプ				
H	W	25~49	~80	~120	~160	~200
30~49		18,700	20,300	22,500	23,700	25,500
	~80	20,900	27,900	31,900	34,500	36,000
	~120	23,100	29,600	34,500	37,900	39,300
	~160	25,300	31,500	38,000	41,400	43,800
	~200	27,500	33,200	41,400	45,700	47,000
	~250	29,600	35,500	45,200	50,000	51,300
	~300	31,800	36,900	49,200	54,300	55,500
	~350	34,000	38,200	51,400	56,900	58,400
	~400	36,700	39,500	53,600	59,700	61,400
	~450	-	42,100	57,400	63,500	65,900

※ 製作可能な幅：高さの比率は、チェーンタイプは1：8以下

ロールスクリーン スタイル掛率適用品

&time 見本帳 270 ページ掲載 / Néο 56、128・129、131 ページ掲載

54447R・54448R

組成：ポリエステル100%



54447R・54448R

		ロールスクリーン				
		スプリングタイプ				
H	W	30~49	~80	~120	~160	~200
30~49		16,800	19,000	21,900	23,400	26,400
	~80	17,600	20,800	23,400	26,200	28,800
	~120	19,300	23,000	25,900	29,000	31,800
	~160	20,600	25,400	28,500	31,800	35,100
	~200	-	28,000	31,400	34,900	38,200
	~250	-	30,200	34,000	37,700	41,300
	~300	-	-	39,300	43,300	47,700

※ 製作可能な幅：高さの比率は、1：3以下

54447R・54448R

		ロールスクリーン				
		チェーンタイプ				
H	W	25~49	~80	~120	~160	~200
30~49		16,800	19,000	21,900	23,400	26,400
	~80	17,600	20,800	23,400	26,200	28,800
	~120	19,300	23,000	25,900	29,000	31,800
	~160	20,600	25,400	28,500	31,800	35,100
	~200	22,100	28,000	31,400	34,900	38,200
	~250	23,900	30,200	34,000	37,700	41,300
	~300	27,300	34,100	39,300	43,300	47,700
	~350	29,200	36,800	41,700	46,300	50,900
	~400	31,600	39,000	44,400	49,300	54,300
	~450	-	41,600	46,900	51,800	56,400

※ 製作可能な幅：高さの比率は、チェーンタイプは1：8以下

&time 見本帳 271 ページ掲載 / Néο 53・54、128～131 ページ掲載

54449R～54456R

組成：ポリエステル100%



ねじり又は緩り禁止

54449R～54456R

		ロールスクリーン				
		スプリングタイプ				
H	W	30~49	~80	~120	~160	~200
30~49		17,900	19,900	23,600	25,200	28,500
	~80	19,000	23,200	26,500	29,200	32,200
	~120	20,800	25,700	28,800	31,500	34,100
	~160	22,200	27,900	31,700	34,800	37,700
	~200	-	30,100	34,900	38,000	41,400
	~250	-	32,600	37,200	42,000	46,000
	~300	-	-	42,900	46,900	51,700

※ 製作可能な幅：高さの比率は、1：3以下

54449R～54456R

		ロールスクリーン				
		チェーンタイプ				
H	W	25~49	~80	~120	~160	~200
30~49		17,900	19,900	23,600	25,200	28,500
	~80	19,000	23,200	26,500	29,200	32,200
	~120	20,800	25,700	28,800	31,500	34,100
	~160	22,200	27,900	31,700	34,800	37,700
	~200	23,800	30,100	34,900	38,000	41,400
	~250	25,700	32,600	37,200	42,000	46,000
	~300	29,500	36,900	42,900	46,900	51,700
	~350	31,500	39,700	45,200	50,000	55,200
	~400	34,100	42,200	48,000	53,300	57,700
	~450	-	45,100	50,800	56,100	-

※ の部分の製作可能面積は6m²以下

※ 製作可能な幅：高さの比率は、チェーンタイプは1：8以下

54449R～54456R

		ロールスクリーン	
		スリットタイプ	
H	W	10~30	
30~120		13,500	
~220		17,000	

※ 製作可能な幅：高さの比率は、1：3以下

&time 見本帳 272 ページ掲載 / Néο 55、128・129、131 ページ掲載

54457R～54460R

組成：ガラス繊維100%
(両面PVCフィルムラミネート)



ガイドブック & 価格表

54457R～54460R

		ロールスクリーン				
		スプリングタイプ				
H	W	30~49	~80	~120	~160	~200
30~49		21,300	23,400	26,100	27,800	30,200
	~80	23,900	29,300	34,600	37,200	38,700
	~120	26,500	31,700	38,700	42,100	43,300
	~160	29,200	34,100	42,900	46,800	49,200
	~200	-	36,400	47,200	52,300	53,700
	~250	-	39,700	52,300	58,200	59,500
	~300	-	-	57,600	64,000	65,300

※ 製作可能な幅：高さの比率は、1：3以下

54457R～54460R

		ロールスクリーン				
		チェーンタイプ				
H	W	25~49	~80	~120	~160	~200
30~49		21,300	23,400	26,100	27,800	30,200
	~80	23,900	29,300	34,600	37,200	38,700
	~120	26,500	31,700	38,700	42,100	43,300
	~160	29,200	34,100	42,900	46,800	49,200
	~200	31,800	36,400	47,200	52,300	53,700
	~250	34,500	39,700	52,300	58,200	59,500
	~300	37,100	41,500	57,600	64,000	65,300
	~350	39,800	43,300	61,300	67,900	69,300
	~400	43,100	46,000	64,800	72,100	73,200
	~450	-	49,300	70,100	78,100	-

※ の部分の製作可能面積は6m²以下

※ 製作可能な幅：高さの比率は、チェーンタイプは1：8以下

ロールスクリーンデュエッタ 特殊掛率品

&time 見本帳 273・274 ページ掲載 / Néο 49 ~ 51, 136 ~ 138 ページ掲載

54461D ~ 54467D

54461D ~ 54467D

組成：ポリエステル100%



【特殊掛率品】ロールスクリーンデュエッタ

		チェーン式					
H	W	30~49	~80	~120	~160	~200	~230
30~49		29,500	31,000	33,300	39,800	41,700	43,500
	~80	31,500	33,000	35,200	43,700	45,600	47,400
	~120	34,000	35,500	37,800	48,600	50,500	52,400
	~160	36,600	38,100	40,300	53,600	55,500	57,400
	~200	39,100	40,600	42,800	58,600	60,500	62,300
	~250	42,200	43,700	45,900	64,700	66,600	68,400

※ の範囲では、製品の中：高さの比率が1：6を
超えるサイズでは製作できません。
※ デュエッタスタイルの価格も上記と同じになります。

プリーツスクリーン スタイル掛率適用品

&time 見本帳 275 ページ掲載 / Néο 59, 139 ~ 141 ページ掲載

54468P ~ 54474P

04 - 54468P ~ 54474P

06 - 54468P ~ 54474P

組成：ポリエステル100%



style no.04 プリーツスクリーン (シングルタイプ)

		コード式			
H	W	25~80	~120	~160	~200
30~60		17,400	21,200	24,400	27,900
	~100	21,000	27,300	30,500	34,500
	~140	27,300	33,000	36,000	40,300
	~180	31,400	37,400	41,500	43,800
	~220	35,500	41,400	47,800	48,200
	~260	41,700	48,000	51,400	55,500
	~300	46,300	55,500	59,300	63,400

※ の範囲では、製品の中：高さの比率が1：10を
超えるサイズは製作できません。

style no.06 プリーツスクリーン (シングルタイプ)

		チェーン式					
H	W	50~80	~120	~160	~200	~240	~280 ~290
30~60		22,400	27,200	32,700	35,700	43,900	58,900 60,000
	~100	26,500	33,000	38,900	42,400	50,200	65,200 66,500
	~140	35,000	40,300	44,300	49,000	55,400	72,200 73,500
	~180	38,800	43,800	49,000	51,900	60,400	78,900 80,700
	~220	43,000	49,300	55,500	61,900	68,900	89,200 90,900
	~260	48,200	55,000	62,000	67,800	72,500	95,500 97,500
	~300	53,200	63,000	69,200	73,500	-	-

※ の範囲では、製品高さが250cmを超えるサイズは製作できません。

05 - 54468P ~ 54474P + 54475P・54476P

style no.05 プリーツスクリーン (ダブルタイプ)

		チェーン式		
H	W	50~80	~120	~160 ~200
30~60		33,400	40,800	47,000 55,100
	~100	38,700	50,700	56,400 64,800
	~140	49,100	60,400	65,200 74,100
	~180	56,300	68,500	74,300 81,600
	~220	63,500	75,900	84,900 90,800
	~250	72,400	85,200	92,900 102,400

※ 仕上り巾は、W200cmまでとなります。

&time 見本帳 275 ページ掲載 / Néο 60, 139 ~ 141 ページ掲載

54475P・54476P

04 - 54475P・54476P

06 - 54475P・54476P

組成：ポリエステル100%



style no.04 プリーツスクリーン (シングルタイプ)

		コード式			
H	W	25~80	~120	~160	~200
30~60		22,900	27,900	31,400	32,300
	~100	25,700	33,500	36,300	37,300
	~140	31,800	39,400	41,300	42,500
	~180	36,200	44,700	46,700	47,900
	~220	40,500	49,400	52,900	54,500
	~260	45,000	53,900	58,800	60,900
	~300	49,400	58,200	64,700	66,700

※ の範囲では、製品の中：高さの比率が1：10を
超えるサイズは製作できません。

style no.06 プリーツスクリーン (シングルタイプ)

		チェーン式					
H	W	50~80	~120	~160	~200	~240	~280 ~290
30~60		35,000	41,700	44,000	45,300	46,800	60,800 64,500
	~100	38,200	46,900	49,400	50,800	54,700	70,500 74,800
	~140	41,000	52,700	55,300	56,500	63,000	81,400 86,300
	~180	44,400	58,700	61,000	62,500	71,300	91,300 96,900
	~220	47,700	64,800	67,800	69,000	80,300	105,700 112,000
	~260	50,400	70,200	73,200	74,400	88,200	115,300 122,300
	~300	53,500	76,000	78,900	80,300	-	-

※ の範囲では、製品高さが250cmを超えるサイズは製作できません。
※ 幅201cm以上は、幅寸法の1/2の位置で生地が重ね合わせ(ジョイント)になります。

54477P・54478P

組成：ポリエステル100%



04- 54477P・54478P

		style no.04 プリーツスクリーン (シングルタイプ)			
		コード式			
H	W	25~80	~120	~160	~200
30~60		27,300	34,500	37,200	38,300
	~100	32,000	41,400	44,000	45,200
	~140	36,200	45,300	51,000	52,200
	~180	39,800	54,700	57,900	59,000
	~220	43,200	58,300	64,900	66,000
	~260	48,700	68,000	71,900	72,900
	~300	54,000	74,800	78,800	79,800

※ の範囲では、製品の巾：高さの比率が1：10を超えるサイズは製作できません。

06- 54477P・54478P

		style no.06 プリーツスクリーン (シングルタイプ)						
		チェーン式						
H	W	50~80	~120	~160	~200	~240	~280	~290
30~60		37,300	45,800	48,200	49,500	52,900	68,800	72,900
	~100	41,400	53,700	56,200	57,500	64,700	83,200	88,300
	~140	45,800	62,200	64,800	66,000	77,400	98,900	105,000
	~180	50,400	70,500	73,200	74,400	89,400	114,000	121,000
	~220	55,000	79,700	82,500	83,900	102,800	133,400	141,700
	~260	59,000	87,500	90,400	91,900	114,400	148,000	157,000
	~300	63,500	96,200	99,000	100,400	-	-	-

※ の範囲では、製品高さが250cmを超えるサイズは製作できません。
※幅201cm以上は、幅寸法の1/2の位置で生地が重ね合わせ(ジョイント)になります。

05- 54477P・54478P + 54475P・54476P

		style no.05 プリーツスクリーン (ダブルタイプ)			
		チェーン式			
H	W	50~80	~120	~160	~200
30~60		45,100	56,500	62,600	68,900
	~100	52,000	68,000	73,400	79,800
	~140	61,300	76,800	84,300	90,700
	~180	68,600	90,300	95,600	102,400
	~220	76,000	98,000	108,100	114,600
	~250	85,000	111,000	119,700	127,000

※ 仕上り巾は、W200cmまでとなります。

プリーツスクリーン スタイル掛率適用品

54479P～54481P

組成：ポリエステル100%



04- 54479P～54481P

		style no.04 プリーツスクリーン (シングルタイプ)			
		コード式			
H	W	25~80	~120	~160	~200
30~60		22,900	27,900	31,400	32,300
	~100	25,700	33,500	36,300	37,300
	~140	31,800	39,400	41,300	42,500
	~180	36,200	44,700	46,700	47,900
	~220	40,500	49,400	52,900	54,500
	~250	45,000	53,900	58,800	60,900

06- 54479P～54481P

		style no.06 プリーツスクリーン (シングルタイプ)						
		チェーン式						
H	W	50~80	~120	~160	~200	~240	~280	~290
30~60		35,000	41,700	44,000	45,300	46,800	60,800	64,500
	~100	38,200	46,900	49,400	50,800	54,700	70,500	74,800
	~140	41,000	52,700	55,300	56,500	63,000	81,400	86,300
	~180	44,400	58,700	61,000	62,500	71,300	91,300	96,900
	~220	47,700	64,800	67,800	69,000	80,300	105,700	112,000
	~250	50,400	70,200	73,200	74,400	88,200	115,300	122,300

※幅201cm以上は、幅寸法の1/2の位置で生地が重ね合わせ(ジョイント)になります。

05- 54479P～54481P + 54475P・54476P

		style no.05 プリーツスクリーン (ダブルタイプ)			
		チェーン式			
H	W	50~80	~120	~160	~200
30~60		40,700	49,900	56,900	62,900
	~100	45,500	60,400	65,700	71,700
	~140	56,800	70,600	74,600	81,200
	~180	64,800	80,400	84,300	91,200
	~220	72,800	89,000	95,900	103,100
	~250	81,000	96,900	106,400	114,800

※ 仕上り巾は、W200cmまでとなります。

ウッドブラインド スタイル掛率適用品

&time 見本帳 277 ページ掲載 / Néó 63・64、142～144 ページ掲載

54482W～54487W

54482W～54487W

組成：バスウッド

ウッドブラインド		スラット巾50mm ラダーコード仕様									
		ドラムタイプ									
	w	35~50	~80	~100	~120	~140	~160	~180	~200	~220	~240
H	仕上り寸法										
50~100	53・57・62・66・70・75・79・83・88・92・96・100	41,000	41,000	45,400	50,300	54,900	57,800	62,100	67,700	72,700	76,300
~120	105・109・113・118	46,600	46,600	50,100	56,200	64,700	68,900	74,600	81,500	87,900	92,600
~140	122・126・131・135・139	49,800	49,800	56,300	63,300	70,100	75,100	81,500	89,300	96,300	101,900
~160	143・148・152・156	52,300	52,300	59,400	67,000	74,500	80,000	87,100	95,400	103,100	109,300
~180	161・165・169・174・178	55,200	55,200	63,400	71,600	79,700	86,300	93,900	103,100	111,500	117,700
~200	182・186・191・195・199	57,800	57,800	66,400	75,400	84,100	91,100	99,500	109,200	117,600	125,200
~220	204・208・212・217	61,000	61,000	70,300	79,900	89,600	97,300	106,300	116,000	127,200	135,400
~240	221・225・229・234・238		63,400	73,500	83,700	93,900	102,300	111,400	125,100	136,300	144,900
~260	242・247・251・255・260	-	66,700	77,400	88,500	99,500	108,500	117,500	133,000	144,800	155,200
~280	264・268・272・277	-	69,500	81,200	93,100	104,800	113,700	125,600	142,000	154,600	165,800
~300	281・285・290・294・298	-	72,300	84,500	96,800	110,400	119,300	132,400	151,300	164,600	-

※ 仕上り寸(H)は太枠部分の「仕上り寸法」よりご注文ください。
 ※ 巾(W)は0.5cm単位でご注文できます。
 ※ 部分の製作可能寸法は6m²までとなります。
 ※ 製品の特性上、仕上り寸法は若干の誤差が生じますのでご了承ください。

木調ブラインド スタイル掛率適用品

&time 見本帳 278 ページ掲載 / Néó 65・66、142～144 ページ掲載

54488W～54491W

54488W～54491W

組成：PVC押し型材



ウッドブラインド(木調ブラインド)		スラット巾50mm ラダーコード仕様									
		ドラムタイプ									
	w	35~50	~80	~100	~120	~140	~160	~180	~200	~220	~240
H	仕上り寸法										
53~100	53・57・62・66・70・75・79・83・88・92・96・100	44,600	44,600	49,300	54,700	59,900	63,000	67,900	73,900	79,400	83,400
~120	105・109・113・118	50,700	50,700	54,500	61,300	70,700	75,300	81,600	89,100	96,100	101,400
~140	122・126・131・135・139	54,300	54,300	61,400	69,200	76,600	82,100	89,100	97,600	105,400	111,500
~160	143・148・152・156	57,000	57,000	65,000	73,200	81,400	87,500	95,300	104,400	112,800	119,700
~180	161・165・169・174・178	60,200	60,200	69,300	78,200	87,300	94,400	102,800	112,800	122,100	129,000
~200	182・186・191・195・199	63,000	63,000	72,500	82,300	92,000	99,800	109,000	119,600	128,800	※1
~220	204・208・212・217	66,600	66,600	76,800	87,400	98,100	106,500	116,500	127,100	※1	
~240	221・225・229・234・238	69,300	69,300	80,400	91,500	102,800	112,000	122,000	※1		
~260	242・247・251・255・260	※2	72,800	84,700	96,900	109,000	118,800	128,700			
~280	264・268・272・277		76,000	88,900	101,800	114,700	124,500				
~298	281・285・290・294・298		79,000	92,400	105,900	121,000	130,700	※1			

※ 仕上り寸(H)は太枠部分の「仕上り寸法」よりご注文ください。
 ※ 巾(W)は0.5cm単位でご注文できます。
 ※ 1 部分の製作可能寸法は4m²までとなります。
 ※ 2 部分の製品仕上り寸法は、221cmとなります。
 ※ 製品の特性上、仕上り寸法は若干の誤差が生じますのでご了承ください。

パーティカルブラインド スタイル掛率適用品

&time 見本帳 279 ページ掲載 / Néó 67・68、145～148 ページ掲載

54492V～54499V

54492V～54499V

組成：ポリエステル100%



パーティカルブラインド 標準タイプ		ルーバー巾100mm							
		コード&バトン式							
	w	30~120	~160	~200	~240	~280	~320	~360	~400
H									
50~100		28,600	33,700	37,700	42,700	47,400	52,400	56,300	60,700
~140		32,800	36,800	41,000	46,700	51,100	62,000	68,800	75,600
~180		34,000	38,500	43,000	49,600	60,400	65,500	72,800	80,400
~220		35,500	40,400	47,500	54,000	63,800	69,400	77,900	85,900
~260		37,400	43,100	50,200	59,300	67,700	77,400	85,700	94,800
~300		39,100	46,600	53,000	62,300	71,800	81,800	90,600	100,200

54492V～54499V

パーティカルブラインド レールジョイント仕様		ルーバー巾100mm						
		コード&バトン式(両開きのみ)						
	w	201~240	~280	~320	~360	~400	~440	~500
H								
50~100		46,300	51,000	56,000	59,900	64,300	68,900	73,300
~140		50,300	60,700	65,600	72,400	79,200	86,400	93,700
~180		53,200	64,000	69,100	76,400	84,000	91,700	99,500
~220		57,600	67,400	73,000	81,500	89,500	97,600	105,500
~260		62,900	71,300	81,000	89,300	98,400	107,300	116,200
~300		65,900	75,400	85,400	94,200	103,800	113,300	122,800

※ ヘッドレールが2本に分割された仕様で施工現場でジョイントすることができます。

寸法変化率の表示について

各商品ごとに寸法変化率 水洗い(タテ・ヨコ)・ドライ(タテ・ヨコ)を表示しております。これらの数値は下記JIS試験に基づいて表示しています。
寸法変化率(%)… 水洗い(タテ・ヨコ): JIS L 1096 D法 / ドライ(タテ・ヨコ): JIS L 1096 J-1法

カーテンの取扱い表示について

洗濯などの取扱い方法を日本工業規格(JIS L 0001)に基づいて表示しています。洗濯やアイロン掛けをする際は、必ず取扱い表示をご確認ください。クリーニング業者には、取扱い表示に基づき洗濯するようご依頼ください。

■ 家庭用品品質表示法: 2016年12月1日から衣類等の洗濯表示の取扱い表示が変わりました。

洗濯処理の記号

 液温は40℃を限度とし、洗濯機で弱い洗濯処理ができる。

 液温は、40℃を限度とし、手洗いによる洗濯処理ができる。

 洗濯処理はできない。

漂白処理の記号

 漂白処理はできない。

乾燥処理の記号

 洗濯処理後のタンブル乾燥処理はできない。

 日陰でのつり干し乾燥がよい。

アイロン仕上げ処理の記号

 底面温度110℃を限度としてスチームなしでアイロン仕上げ処理ができる。

 アイロン仕上げ処理はできない。

ドライクリーニング処理の記号

 石油系溶剤(蒸留温度150℃～210℃、引火点38℃～)での弱いドライクリーニング処理ができる。

ウエットクリーニング処理の記号

 弱いウエットクリーニング処理ができる。

 非常に弱いウエットクリーニング処理ができる。

 ウエットクリーニング処理はできない。

※タンブラー乾燥は避けてください。
ドラム式乾燥機の乾燥は、風合い・寸法変化が起きることがあります。使用は避けてください。

○取扱い表示 家庭用品品質表示法に基づき、適切なメンテナンスが行えるよう、それぞれのカーテンに合った取扱い表示ラベルを生地4mに付1枚添付しています。

取扱い表示一覧

価格表に記載してある取扱い表示の内容について、下図をご参照ください。なお、生地をご注文いただいた際は、それぞれのカーテンに合った取扱い表示ラベルを生地4mにつき1枚同封の上出荷しております。

エ-2

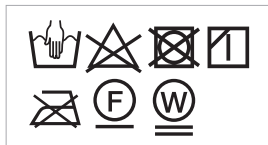

エ-17

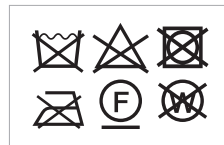

リ-30



あて布使用

リ-33

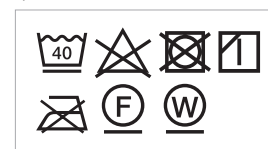

形状記憶・形態安定加工品

左記リ-30の取扱い表示は、
形態安定・形状記憶加工後に、
取扱い表示が変わります。

カーテンのお手入れ方法

日頃のお手入れ

■ カーテンのお手入れ、忘れていませんか？

カーテンの汚れの原因は、空気中のほこりやタバコのヤニ、キッチンから出る煙などです。日頃から、お掃除の際生地を傷めないよう軽くふりはたくか、軽く掃除機をかけるなどしてほこりを落としてください。また、カーテンレールや窓ガラスもお手入れすることをおすすめします。カーテンレールや窓ガラスの汚れは、カーテンへ移りやすだけでなく、ほこりやごみが水分を含むことで、カビも発生しやすくなります。また、結露もカビや汚れの原因になりますので、こまめにお手入れを行ってください。

■ どのくらいの割合で洗濯すればいいの？

ドレープカーテンは年に1回程度、レースカーテンは年に2～3回程度が目安となります。時間が経つほど汚れが落ちにくくなるだけでなく、繊維の脆化の原因となります。

安全対策

～ 製品を安全に使用していただくために ～



警告

タッセル(カーテンの留めひも)が体にまきついたり、引っかかるようなことをしないでください。事故の恐れがあります。小さなお子様のいらっしゃる場合には特にご注意ください。



警告

子供は思わぬ行動を取ります。大人の常識は通用しません。子供をコードやチェーンで遊ばせないように注意してください。



警告

コードやチェーンが体にまきついたり、引っかかるようなことをしないでください。事故の恐れがあります。



警告

小さなお子さまがいるご家庭では、ブラインドやスクリーンのコードやチェーン類の近くにソファやベッドを置かないでください。ソファやベッドに上がれば手が届き、事故の恐れがあります。



安全対策品をご使用になっても、事故が完全に回避されるわけではありません。
コードやチェーンの危険性を十分に認識したうえでご使用をお願いします。

一般社団法人 日本インテリア協会

リリカラ株式会社

東京ショールーム	〒160-8315	東京都新宿区西新宿 7-5-20 2F	TEL.03-3366-7824
大阪ショールーム	〒550-0005	大阪府大阪市西区西本町 2-2-2 なにわ筋中央ビル6F	TEL.06-7670-5125
福岡ショールーム	〒810-0071	福岡県福岡市中央区那の津 2-6-4 3F	TEL.092-714-3835

■ 首都圏営業部	〒160-8315	東京都新宿区西新宿 7-5-20	TEL.03-3366-7825
■ 営業開発部	〒160-8315	東京都新宿区西新宿 7-5-20	TEL.03-3366-7865
■ 札幌支店	〒063-0832	北海道札幌市西区発寒12条 12-2-20	TEL.011-666-2125
■ 東北支店	〒983-0004	宮城県仙台市宮城野区岡田西町 3-10	TEL.022-288-3185
■ 大阪支店	〒579-8037	大阪府東大阪市新町 11-8	TEL.072-947-3005
■ 広島支店	〒738-0021	広島県廿日市市木材港北 5-52	TEL.0829-32-4555
■ 九州支店	〒810-0071	福岡県福岡市中央区那の津 2-6-4	TEL.092-781-8125

<https://www.lilycolor.co.jp>

製 作／リリカラ株式会社
製 作 責 任 者／山田俊之
発 行／2021 年 9 月

